

IRWIN® UNIVERSITY

IRWIN® is committed to the pursuit of developing tools to get the job done right. Our commitment extends beyond our broad assortment of innovative IRWIN® products to include the development of our employees and valued customers. We are dedicated to delivering best-in-class career and industry development opportunities through a variety of product training programs.

INSTRUCTOR-LED PRODUCT TRAINING

The IRWIN® University is a state-of-the-art facility dedicated to IRWIN® product development and training. IRWIN® employees participate in a variety of multi-day training programs led by highly skilled facilitators to expand their knowledge of IRWIN® hand tools and power tool accessories. These hands-on courses range from introductory product knowledge overviews to more advanced curriculum including jobsite assessment, phases of construction, and hands-on, real-world product applications.



IRWIN® DESIGN CENTRES

IRWIN® has been delivering high-quality and innovative products for over a century. The experience and knowledge to design and build the IRWIN® products with rigorous testing and quality control are fundamental parts in our ability to offer the best products. Our testing centre facilities across the globe ensure exactly that. The centres opposite use the very latest technology and testing methods within their specific areas of expertise.



NEW PRODUCTS

IRWIN Tools' end-user obsession, combined with world-class product development, enables us to produce professional-grade hand tools and power tool accessories that provide superior performance and durability on the job.

By incorporating end-user feedback with advanced engineering, we deliver innovative products that continue to surpass industry standards.

880 PLUS UNIVERSAL HANDSAW



MS750 CHISELS



FK150 FOLDING KNIFE



FAST RELEASE LOCKING PLIERS



MULTI-VICE



GROOVELOCK WATER PUMP PLIERS



DOUBLE-ENDED IMPACT BIT

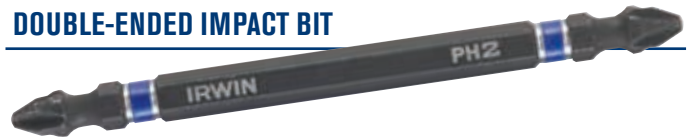

BLUEGROOVE 6X SPEEDBOR



MARPLES® CIRCULAR SAW BLADES



	Page
HAND TOOLS	4
Pliers & Wrenches	5
Metal Cutting	23
Woodworking	30
Workholding	42
Spare Parts	57
Utility Knives & Blades	59
Layout Tools	66
Tool Storage & Workwear	71
Plumbing Tools	77
POWER TOOL ACCESSORIES	84
Masonry Drilling	87
Metal Drilling	101
Wood Drilling	117
Screwdriving	125
Fastener Drives	132
Drilling Sets	135
Circular Saw Blades	142
Linear Edge	150
Bi-Metal Hole Saws	152
Reciprocating Saw Blades	154
Jigsaw Blades	158
Index	160



WISE-GRIP®

The VISE-GRIP® Locking Tool was invented in the 1924 by a blacksmith in a small town of DeWitt, Nebraska. William Petersen was a Danish immigrant who invented the first locking pliers in his blacksmith shop, and began selling them from the back of his car to farmers and people in surrounding towns. He patented his new idea and called it VISE-GRIP®.

Since then, VISE-GRIP® has gained global brand recognition as the first choice for Locking Pliers. Innovation and quality are the core values of the VISE-GRIP® brand. With proven performance in every turn, these are the tools that tradesmen choose first – and pass on to the next generation.

The IRWIN® VISE-GRIP® family offers a full line of locking pliers, water pump & VDE Pliers, certified by TÜV/GS. IRWIN® VISE-GRIP® pliers and wrenches continue to set the standard for dependability, quality, and innovation... today and tomorrow. Wherever there's a need for a quality tool, IRWIN® VISE-GRIP® is on the job.



Record®

Originally established in 1898 in the South Yorkshire city of Sheffield in the UK. The Record Tools Factory was swiftly able to make a long lasting contribution to the worldwide reputation of the region for the manufacture of high quality steel and castings.

The Record® brand name was introduced in 1909 and by the 1920's the product range had expanded into Vices, Planes, Clamps and Pipe Wrenches enabling the business to grow rapidly in the UK and many overseas markets.

Today, IRWIN® Record® continues excelling by sticking to the traditional values set by its founders, producing tools that are highly valued amongst professional users for quality and durability that remains strong today.



PLIERS AND WRENCHES

LOCKING TOOLS



PLIERS



WRENCHES



Fast Release

LOCKING PLIERS

The NEW IRWIN® Vise-Grip® Fast Release locking tools have a one handed, triggerless release, so they're twice as easy to open as the traditional design. Anti-pinch, non-slip ProTouch™ Grips provide comfort, control, and less hand fatigue.

IRWIN® VISE-GRIP® 10CR FAST RELEASE

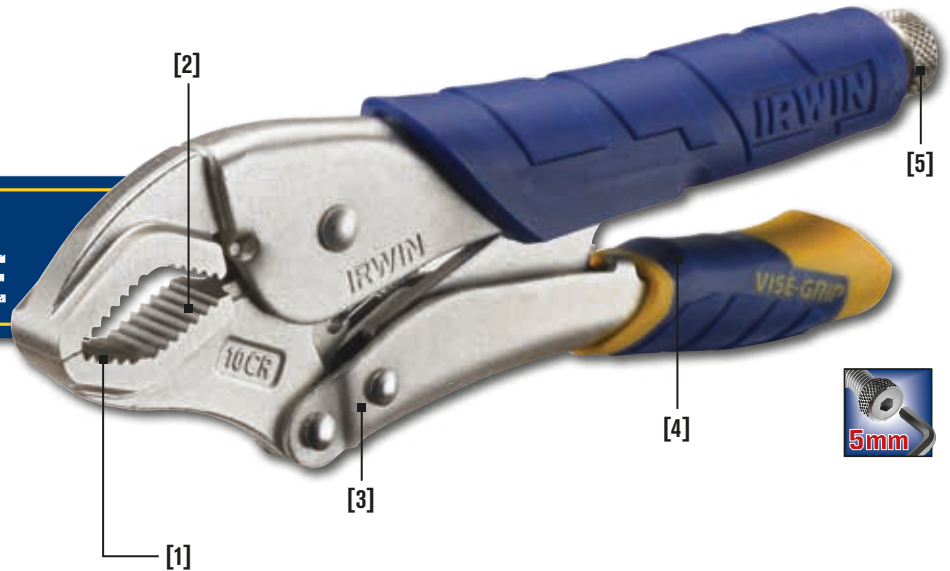

1. UNIQUE CURVED JAW

Great for securely gripping and torquing multiple surface shapes, including round pipes, square or hex bolts, and more. Perfect for any application that requires maximum torque.

2. SELF-ENERGISING LOWER JAW

Jaw mechanism provides 3X more gripping power*. Pivot allows jaw to align on workpiece for maximum grip without slipping or stripping.

3. BUILT STRONG TO LAST LONG

2x Longer life* High grade alloy steel is heat treated for maximum toughness and durability.

4. PROTOUCH™ GRIPS

Provides comfort, control and less hand fatigue.

5. HEX KEY ADJUSTING SCREW

Tightens to draw material closer together for tighter grip. Loosens to provide controlled release.

**ProTouch™
GRIPS**

2X

EASIER OPENING*



*vs. Traditional Locking Pliers

CURVED JAW LOCKING PLIERS

Self-energising lower jaw provides three times more gripping power, with no slipping or stripping on any style nut or bolt head.

Item No.	Description	Capacity	EAN	Master Pack	Shelf Pack	LP Ex VAT £ / Item	RRP Inc VAT £ / Item	DISC. CODE	
Fast Release									
T10T	Fast Release - 5CR 5"/ 125mm	29mm	5706915081459	25	5	15.04	18.05	OR (HT)	
T13T	Fast Release - 7CR 7"/ 175mm	38mm	5706915081442	25	5	16.23	19.48		
T11T	Fast Release - 10CR 10"/ 250mm	48mm	5706915081435	25	5	18.65	22.38		
The Original									
10508019	Original - 5CR 5"/ 125mm	29mm	5706915080193	25	5	13.68	16.42		
10508018	Original - 7CR 7"/ 175mm	38mm	5706915080186	25	5	14.76	17.71		
10508017	Original - 10CR 10"/ 250mm	48mm	5706915080179	25	5	16.96	20.35		

STRAIGHT JAW LOCKING PLIERS

Straight jaw provides maximum contact on flat, square or hex materials.

Item No.	Description	Capacity	EAN	Master Pack	Shelf Pack	LP Ex VAT £ / Item	RRP Inc VAT £ / Item	DISC CODE
Fast Release								
T03T	Fast Release - 7R 7"/ 175mm	38mm	5706915081800	25	5	16.23	19.48	IR (HT)
T01T	Fast Release - 10R 10"/ 250mm	48mm	5706915081794	25	5	18.65	22.38	
The Original								
T0302EL4	Original - 7R 7"/ 175mm	38mm	0038548003016	25	5	14.76	17.71	IR (HT)
T0102EL4	Original - 10R 10"/ 250mm	48mm	0038548001067	25	5	16.96	20.35	



CURVED JAW LOCKING PLIERS WITH WIRE CUTTER

Curved jaw with built-in wire cutter great for a variety of applications and material shapes.

Item No.	Description	Capacity	EAN	Master Pack	Shelf Pack	LP Ex VAT £ / Item	RRP Inc VAT £ / Item	DISC CODE
Fast Release								
T09T	Fast Release - 5WR 5"/ 125mm	29mm	5706915081428	25	5	15.04	18.05	IR (HT)
T07T	Fast Release - 7WR 7"/ 175mm	38mm	5706915081411	25	5	16.23	19.48	
T05T	Fast Release - 10WR 10"/ 250mm	48mm	5706915081404	25	5	18.65	22.38	
The Original								
T1002EL4	Original - 4WR 4"/ 100mm	25mm	0038548001098	25	5	12.63	15.16	IR (HT)
T0902EL4	Original - 5WR 5"/ 125mm	29mm	0038548009063	25	5	13.68	16.42	
T0702EL4	Original™ - 7WR 7"/ 175mm	38mm	0038548007038	25	5	14.76	17.71	
T0502EL4	Original - 10WR 10"/ 250mm	48mm	0038548000510	25	5	16.96	20.35	



LONG NOSE LOCKING PLIERS WITH WIRE CUTTER

Long, straight nose provides easy access in narrow, hard-to-reach places.

Item No.	Description	Capacity	EAN	Master Pack	Shelf Pack	LP Ex VAT £ / Item	RRP Inc VAT £ / Item	DISC CODE
Fast Release								
T14T	Fast Release - 6LN 6"/150mm	51mm	5706915081466	25	5	19.07	22.88	IR (HT)
T15T	Fast Release - 9LN 9"/225mm	70mm	5706915081473	25	5	21.48	25.78	
The Original								
T1602EL4	Original - 4LN 4"/100mm	41mm	0038548001678	25	5	15.76	18.91	IR (HT)
T1402EL4	Original - 6LN 6"/150mm	51mm	0038548001432	25	5	17.33	20.80	
T1502EL4	Original - 9LN 9"/225mm	70mm	0038548001517	25	5	19.52	23.42	



LOCKING C-CLAMPS WITH REGULAR TIPS

Wide-opening jaw provides greater versatility in clamping a variety of shapes.

Item No.	Description	Capacity	EAN	Master Pack	Shelf Pack	LP Ex VAT £ / Item	RRP Inc VAT £ / Item	DISC CODE
Fast Release								
10507190	Fast Release - 6R 6"/150mm	54mm	5706915071900	25	5	18.19	21.83	IR (HT)
10507189	Fast Release - 11R 11"/275mm	102mm	5706915071894	25	5	32.32	38.78	
The Original								
T17EL4	Original - 6R 6"/150mm	54mm	0038548001715	25	5	16.54	19.85	IR (HT)
T19EL4	Original - 11R 11"/275mm	102mm	0038548001913	25	5	29.39	35.27	
T18R	Original - 18R - 18"/455mm	203mm	0038548000213	-	5	42.23	50.68	
T24R	Original - 24R - 24"/605mm	254mm	0038548002750	-	5	52.57	63.08	

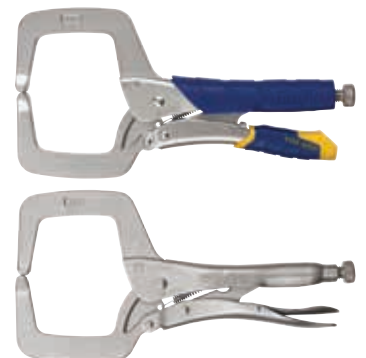

LOCKING C-CLAMPS - DEEP THROAT

The large C-Clamp with greater throat capacity makes this a highly versatility tool in the clamping of wider work-pieces.

Item No.	Description	Capacity	EAN	Master Pack	Shelf Pack	LP Ex VAT £ / Item	RRP Inc VAT £ / Item	DISC CODE
T9DR	Original - 9DR Locking Clamp Deep Throat 9"/225mm	114mm	0038548003009	-	5	21.32	25.58	IR (HT)
T18DR	Original - 18DR Locking Clamp Deep Throat 18"/455mm	190mm	0038548002118	-	5	51.50	61.80	



LOCKING C-CLAMPS WITH SWIVEL PADS

The swiveling pads and greater throat depth allow this clamp to be hold irregular shapes and tapered work pieces.



Item No.	Description	Capacity	EAN	Master Pack	Shelf Pack	LP Ex VAT £ / Item	RRP Inc VAT £ / Item	DISC. CODE
T165EL4	Original - 4SP Locking C-Clamp 4"/100mm	41mm	0038548001661	25	5	16.89	20.27	IR (HT)
T18EL4	Original - 6SP Locking C-Clamp 6"/150mm	54mm	0038548001845	25	5	19.43	23.32	
T9SP	Original - 9SP Locking C-Clamp 9"/225mm	114mm	0038548003108	25	5	27.70	33.24	
T20EL4	Original - 11SP Locking C-Clamp 11"/275mm	102mm	0038548002019	25	5	31.67	38.00	
T18SP	Original - 18SP Locking C-Clamp 18"/455mm	203mm	0038548000220	-	5	43.49	52.19	
T24SP	Original - 24SP Locking C-Clamp 24"/605mm	254mm	0038548000282	-	5	56.57	67.88	

LOCKING WRENCHES

The jaws lock onto 3 sides of a hex fastener preventing the jaws from slipping, preventing rounding or marring of the fastener.



Item No.	Description	Capacity	EAN	Master Pack	Shelf Pack	LP Ex VAT £ / Item	RRP Inc VAT £ / Item	DISC. CODE
8	Original - 4LW Locking Wrench 4"/100mm	7-14mm	0038548002422	25	5	17.27	20.72	IR (HT)
4	Original - 7LW Locking Wrench 7"/175mm	11-19mm	0038548002415	25	5	19.68	23.62	
2	Original - 10LW Locking Wrench 10"/250mm	16-28mm	0038548000046	25	5	21.85	26.22	

LARGE JAW LOCKING PLIERS

The large jaw clamps expand your use of locking pliers to many new applications. Excellent for plumbing and automotive applications.



Item No.	Description	Capacity	EAN	Master Pack	Shelf Pack	LP Ex VAT £ / Item	RRP Inc VAT £ / Item	DISC. CODE
12L3	Original - 12LC Large Jaw Locking Plier 12"/300mm	79mm	0038548012018	25	5	29.80	35.76	IR (HT)

LOCKING SHEET METAL TOOL

In the forming and shaping of sheet material, the sheet metal tool allows for the safe handling of the metal.



Item No.	Description	Capacity	EAN	Master Pack	Shelf Pack	LP Ex VAT £ / Item	RRP Inc VAT £ / Item	DISC. CODE
23	Original - 8R Locking Sheet Metal Tool 8"/200mm	78mm	0038548000237	25	5	26.09	31.31	IR (HT)

LOCKING PINCH-OFF TOOL

The pinch-off tool provides a temporary seal when applied to tubing, leaving both hands free for other work.



Item No.	Description	Capacity	EAN	Master Pack	Shelf Pack	LP Ex VAT £ / Item	RRP Inc VAT £ / Item	DISC. CODE
29	Original - 7RR Locking Pinch-Off Tool 7"/175mm	6mm	0038548000299	25	5	21.32	25.58	IR (HT)

LOCKING PANEL CLAMP

Provides quick clamping and alignment of auto body panels.



Item No.	Description	Capacity	EAN	Master Pack	Shelf Pack	LP Ex VAT £ / Item	RRP Inc VAT £ / Item	DISC. CODE
251	Original - 9AC Locking Panel Clamp 9"/225mm	70mm	0038548002514	25	5	31.05	37.26	IR (HT)

LOCKING WELDING CLAMP

Allows accurate alignment of both round & squares shapes tubing during welding. U-shape jaws allow visibility of the weld area.



Item No.	Description	Capacity	EAN	Master Pack	Shelf Pack	LP Ex VAT £ / Item	RRP Inc VAT £ / Item	DISC. CODE
25ZR	Original - 9R Locking Welding Clamp 9"/225 mm	70 mm	0038548000251	25	5	31.05	37.26	IR (HT)

LOCKING CHAIN CLAMP

Holds and locks any shape or size up to 18"/455mm. Extension chains are available to extend to any length required.

Item No.	Description	EAN	Master Pack	Shelf Pack	LP Ex VAT £ / Item	RRP Inc VAT £ / Item	DISC. CODE
27ZR	Original - 20R Locking Chain Clamp 9"/225mm	0038548000275	10	5	32.18	38.62	IR (HT)
40EXT	Original - 20EXT Extension chain 18"/455mm, fits 20R	0038548000404	1	1	17.57	21.08	
40REP	Original - 20REP Replacement chain 18"/455mm, fits 20R	0038548001401	1	1	18.10	21.72	

LOCKING PLIERS SPARE PARTS

Item No.	Description	EAN	Pce per Pack	Master Pack	Shelf Pack	LP Ex VAT £ / Item	RRP Inc VAT £ / Item	DISC. CODE
2071910	Adjusting Screw 5 Pc. - 10R, 10WR, 10CR, 20R, 12LC, 11R, 11SP, 18R, 18SP, 24R, 24SP, & 10LW	0038548095455	5	100	5	1.09	1.31	IR (HT)
4092	Replacement spring 5pc - 4WR, 4LN, 4SP, 4LW	0038548040929	5	100	5	1.09	1.31	
4935309	Replacement spring 5pc - 18R, 18SP, 24R, 24SP (box and packs marked 40-34)	0038548040349	5	100	5	1.09	1.31	
4008	Replacement spring 5pc - 10R, 10WR, 10CR, 11R, 11SP, 20R, 12LC, 10LW	0038548040080	5	100	5	1.09	1.31	
4022ZR	Replacement spring 5pc - 7R, 7WR, 7CR, 9LN, 8R, RR, 7LW	0038548040226	5	100	5	1.09	1.31	
4052ZR	Replacement spring 5pc - 5WR, 6LN, 6R, 6SP	0038548040523	5	100	5	1.09	1.31	



LOCKING PLIERS SETS



T77T



T214T



T76KBT













10508020











T71

Item No.	Description	EAN	Master Pack	Shelf Pack	LP Ex VAT £ / Item	RRP Inc VAT £ / Item	DISC. CODE
T77T	2 pc. Fast Release - (10WR, 6LN)	5706915081480	25	5	35.82	42.98	IR (HT)
T214T	2 pc. Fast Release - (10WR, 7WR)	5706915081497	25	5	33.15	39.78	
T76KBT	3 pc. Fast Release - (10WR, 9LN, 7R) in kitbag	5706915081503	25	5	56.35	67.62	
10508020	3 pc. Original - (5CR, 7CR, 10CR) in storage tray	5706915080209	25	5	45.38	54.46	
T71	4 pc. Original - (10CR, 7R, 6LN, 5WR), in kitbag	0038548000718	-	5	62.71	75.25	

LOCKING PLIER RANGE OVERVIEW

Image	Item No.	Description	Sizes	Jaw Capacity	Description	Recommended Applications
	T10T	5CR 5"/ 125mm	5" / 125mm	1-1/8" (29 mm)	CURVED JAW LOCKING PLIERS Great for securely gripping and torquing multiple surface shapes, including round pipes, square or hex bolts, and more. Perfect for any application that requires maximum torque.	Gripping Torque Rusted/Broken Screws
	T13T	7CR 7"/ 175mm	7" / 175mm	1-1/2" (38 mm)		
	T11T	10CR 10"/ 250mm	10" / 250mm	1-7/8" (48 mm)		
	10508019	5CR 5"/ 125mm	5" / 125mm	1-1/8" (29 mm)		
	10508018	7CR 7"/ 175mm	7" / 175mm	1-1/2" (38 mm)		
	10508017	10CR 10"/ 250mm	10" / 250mm	1-7/8" (48 mm)		
	T03T	7R 7"/ 175mm	7" / 175mm	1-1/2" (38 mm)	STRAIGHT JAW LOCKING PLIERS The straight jaw pliers with heavy-duty jaws allow for maximum contact on all work shapes flat or square. It is very popular in welding and other metal work. Use for safer grinding or as a portable vice. The solid steel head makes this tool twice as strong as all other locking pliers.	Holding Welding Clamping
	T01T	10R 10"/ 250mm	10" / 250mm	1-7/8" (48 mm)		
	T0302EL4	7R 7"/ 175mm	7" / 175mm	1-1/2" (38 mm)		
	T0102EL4	10R 10"/ 250mm	10" / 250mm	1-7/8" (48 mm)		
	T09T	5WR 5"/ 125mm	5" / 125mm	1-1/8" (29 mm)	CURVED JAW LOCKING PLIERS WITH WIRE CUTTER The curved jaw pliers provide for a better fit around curved work shapes. Curved jaw with built-in wire cutter great for a variety of applications and material shapes.	Wire Cutting Pulling, Prying Gripping
	T07T	7WR 7"/ 175mm	7" / 175mm	1-1/2" (38 mm)		
	T05T	10WR 10"/ 250mm	10" / 250mm	1-7/8" (48 mm)		
	T1002EL4	4WR 4"/ 100mm	4" / 100mm	1" (25 mm)		
	T0902EL4	5WR 5"/ 125mm	5" / 125mm	1-1/8" (29 mm)		
	T0702EL4	7WR 7"/ 175mm	7" / 175mm	1-1/2" (38 mm)		
	T0502EL4	10WR 10"/ 250mm	10" / 250mm	1-7/8" (48 mm)		
	T14T	6LN 6"/ 150mm	6" / 150mm	2" (51 mm)	LONG NOSE LOCKING PLIERS WITH WIRE CUTTER The long tapered nose plier is ideal for delicate work, hobbies, tight spaces, electronics and clamping of small parts. The long nose plier features a built in wire cutter which is helpful in tight spaces.	Reaching Bending Pinching
	T15T	9LN 9"/ 225mm	9" / 225mm	2-3/4" (70 mm)		
	T1602EL4	4LN 4"/ 100mm	4" / 100mm	1-5/8" (41 mm)		
	T1402EL4	6LN 6"/ 150mm	6" / 150mm	2" (51 mm)		
	T1502EL4	9LN 9"/ 225mm	9" / 225mm	2-3/4" (70 mm)		
	10507190	6R 6"/ 150mm	6" / 150mm	2-1/8" (54 mm)	LOCKING C-CLAMPS WITH REGULAR TIPS The wide-opening jaws provide the user greater versatility in clamping projects than otherwise available with old fashioned clamps. The C-clamps with regular tips is very popular in welding, auto-body repair and other metal work. The fast release option allows users to move the clamps quickly with one hand while continuing to work with the other.	Fabricating Welding Construction
	10507189	11R 11"/ 275mm	11" / 275mm	4" (102 mm)		
	T17EL4	6R 6"/ 150mm	6" / 150mm	2-1/8" (54 mm)		
	T19EL4	11R 11"/ 275mm	11" / 275mm	4" (102 mm)		
	T18R	18R 18"/ 455mm	18" / 455mm	8" (203 mm)		
	T24R	24R 24"/ 605mm	24" / 254mm	10" (254 mm)		

Pliers and Wrenches

Image	Item No.	Description	Sizes	Jaw Capacity	Description	Recommended Applications
	T165EL4 T18EL4 T9SP T20EL4 T18SP T24SP	4SP 4"/ 100mm 6SP 6"/ 150mm 9SP 9"/ 225mm 11SP 11"/ 275mm 18SP 18"/ 455mm 24SP 24"/ 605mm	4"/ 100mm 6"/ 150mm 9"/ 225mm 11"/ 275mm 18"/ 455mm 24"/ 254mm	1-5/8" (41 mm) 2-1/8" (54 mm) 4-1/2" (114 mm) 4" (102 mm) 8" (203 mm) 10" (254 mm)	LOCKING C-CLAMPS WITH SWIVEL PADS The wide-opening jaws with swivel pads hold tapered work, awkward fabricating jobs and delicate projects. The C-Clamps with swivel pads are very popular in auto-body repair and other work on delicate or odd shaped surfaces.	Holding Delicate Seams
	T9DR T18DR	9DR 9"/ 225mm 18DR 18"/ 455mm	9"/ 225mm 18"/ 455mm	4-1/2" (114 mm) 7-1/2" (190 mm)	LOCKING C-CLAMPS - DEEP THROAT These clamps have extra throat width and depth for greater clamping reach. These features allow for many clamping applications in welding, automotive and steel framing.	Fabricating Welding Construction
	23	8R 8"/ 200mm	8"/ 200mm	3-1/8" (78 mm)	LOCKING SHEET METAL TOOL The Locking Sheet Metal tool locks to work with powerful grip. Makes all kinds of bending, forming, crimping jobs easier and faster.	Bending Crimping Forming
	25ZR	9R 8"/ 225mm	9"/ 225mm	2-3/4" (70 mm)	LOCKING WELDING CLAMP The Locking Welding Clamp has deep-throated and U-shaped jaws for visibility and working space. Holds work in proper alignment. Use on sheet metal work on automobiles.	Welding Holding
	27ZR	20R 9"/ 225mm	9"/ 225mm	18" (455 mm)	LOCKING CHAIN CLAMP The Locking Chain Clamp holds and locks around any shape or any size of object and adjusts quickly for ratchet action in either direction. Extension chain is available.	Holding
	29	RR 7"/ 175mm	7"/ 175mm	1/4" (6 mm)	LOCKING PINCH-OFF TOOL The Locking Pinch-Off tool with round jaws pinches and locks on tubing instantly without damaging the tubing. Perfect to use for plumbing work, stops flow from untidy tubes. Very popular in the refrigeration market.	Holding
	251	9AC Locking Panel Clamp	9"/ 225mm	2-3/4" (70 mm)	LOCKING PANEL CLAMP The jaws for the Locking Panel Clamp are designed to move in a straight line motion which allows the handle to be out of the way. Auto-body panels can be clamped in place and the door shut to check for gaps before final welding.	Clamping Welding
	8 4 2	4LW 4"/ 100mm 7LW 7"/ 175mm 10LW 10"/ 250mm	4"/ 100mm 7"/ 175mm 10"/ 250mm	(7 mm - 14 mm) (11 mm - 19 mm) (16 mm - 28 mm)	LOCKING WRENCH The jaws of the Locking Wrench lock on three sides of a bolt and will not slip or mark. The Locking Wrench is adjustable to over 16 wrench sizes and features a built-in wire cutter.	Pulling Tightening
	12L3	12LC 12"/ 300mm	12"/ 300mm	3-1/8" (79 mm)	LARGE JAW LOCKING PLIER The large jaws and clamping ability make this tool ideal for plumbers, mechanics, welders and others who work with large objects. Also, its convenient size makes it easier to use than bulkier tools, such as pipe wrenches.	Holding Clamping

IRWIN®

WISE-GRIP®



GROOVELOCK WATER PUMP PLIERS WITH PROTOUCH™ GRIP

GrooveLock Pliers are designed with twice the number of groove positions of traditional groove joint pliers to deliver optimal hand and jaw positioning - providing a superior grip. The specially engineered, all-purpose jaw grips round, hex, square and flat surfaces for incredible versatility.

GrooveLock
Pliers

IRWIN® VISE-GRIP® GV10 GROOVELOCK

1. ALL-PURPOSE JAW:

Grips onto flat, round, hex & square work pieces to provide tremendous bite.

2. PRESS-N-SLIDE BUTTON:

Adjusts jaws 2X faster than traditional groove joint pliers.

3. MULTI-GROOVE RATCHETING SYSTEM:

Has twice the groove positions than other groove joint pliers, for precise positioning on any type of work surface.

4. ANTI-PINCH NON-SLIP PROTOUCH™ GRIPS:

Provide comfort, control and less hand fatigue.



2X FASTER*
*vs traditional Groove Joint pliers



ProTouch
GRIPS

GROOVELOCK PLIERS

GROOVELOCK WATER PUMP PLIERS WITH PROTOUCH™ GRIP

Item No.	Description	Jaw Capacity	EAN	Master Pack	Shelf Pack	LP Ex VAT £ / Item	RRP Inc VAT £ / Item	DISC. CODE
10507626	GV6 GrooveLock PTG 6"/150mm	29mm	5706915076264	25	5	17.38	20.86	IR (HT)
10507627	GV8 GrooveLock PTG 8"/200mm	45mm	5706915076271	25	5	18.60	22.32	
10507628	GV10 GrooveLock PTG 10"/250mm	57mm	5706915076288	25	5	21.70	26.04	
4935097	GV10S GrooveLock PTG 10"/250mm Smooth Jaw	57mm	0038548108629	25	5	21.70	26.04	
10507629	GV12 GrooveLock PTG 12"/300mm	70mm	5706915076295	25	5	26.90	32.28	
2078116	GV16 GrooveLock PTG 16"/400mm	114mm	0038548088099	10	2	49.39	59.27	
2078120	GV20 GrooveLock PTG 20"/510mm	152mm	0038548088105	5	1	68.36	82.03	



GROOVELOCK WATER PUMP PLIERS WITH THIN GRIP

Item No.	Description	Jaw Capacity	EAN	Master Pack	Shelf Pack	LP Ex VAT £ / Item	RRP Inc VAT £ / Item	DISC. CODE
10507630	GV6 GrooveLock TG 6"/150mm	29mm	5706915076301	25	5	17.38	20.86	IR (HT)
10507631	GV8 GrooveLock TG 8"/200mm	45mm	5706915076318	25	5	18.60	22.32	
10507632	GV10 GrooveLock TG 10"/250mm	57mm	5706915076325	25	5	21.70	26.04	
10507633	GV12 GrooveLock TG 12"/300mm	70mm	5706915076332	25	5	26.90	32.28	



WATER PUMP PLIERS

UNIVERSAL WATER PUMP PLIERS WITH PROTOUCH GRIP



Item No.	Description	Jaw Capacity	EAN	Master Pack	Shelf Pack	LP Ex VAT £ / Item	RRP Inc VAT £ / Item	DISC. CODE
10507634	Universal Water Pump Pliers PTG 6"/150mm	29mm	5706915076349	25	5	15.64	18.77	IR (HT)
10507635	Universal Water Pump Pliers PTG 8"/200mm	45mm	5706915076356	25	5	16.74	20.09	
10507636	Universal Water Pump Pliers PTG 10"/250mm	57mm	5706915076363	25	5	19.54	23.45	
10507637	Universal Water Pump Pliers PTG 12"/300mm	70mm	5706915076370	25	5	24.21	29.05	

UNIVERSAL WATER PUMP PLIERS WITH THIN GRIP



Item No.	Description	Jaw Capacity	EAN	Master Pack	Shelf Pack	LP Ex VAT £ / Item	RRP Inc VAT £ / Item	DISC. CODE
10507638	Universal Water Pump Pliers TG 6"/150mm	29mm	5706915076387	25	5	15.64	18.77	IR (HT)
10507639	Universal Water Pump Pliers TG 8"/200mm	45mm	5706915076394	25	5	16.74	20.09	
10507640	Universal Water Pump Pliers TG 10"/250mm	57mm	5706915076400	25	5	19.54	23.45	
10507641	Universal Water Pump Pliers TG 12"/300mm	70mm	5706915076417	25	5	24.21	29.05	

GROOVE JOINT PLIERS

IRWIN® WISE-GRIP® Groove Joint pliers feature right angle teeth which grip in all directions for maximum bite. They all have moulded ProTouch™ grips for added comfort and less hand fatigue.



Item No.	Description	Jaw Capacity	EAN	Master Pack	Shelf Pack	LP Ex VAT £ / Item	RRP Inc VAT £ / Item	DISC. CODE
10505498	Groove Joint Plier 8"/200mm	38mm	5706915054989	25	5	9.02	10.82	IR (HT)
10505500	Groove Joint Plier 10"/250mm	51mm	5706915055009	25	5	10.32	12.38	
10505502	Groove Joint Plier 12"/300mm	57mm	5706915055023	25	5	11.62	13.94	

WISE-GRIP PLIERS

IRWIN® VISE-GRIP® pliers have induction hardened cutting edges which stay sharp longer. The pliers also feature machined jaws for maximum gripping strength and moulded ProTouch™ grips for added comfort and less hand fatigue. TÜV/GS approvals demonstrate the high manufacturing standards of the VISE-GRIP® sub-brand.

COMBINATION PLIERS



Item No.	Description	EAN	Master Pack	Shelf Pack	LP Ex VAT £ / Item	RRP Inc VAT £ / Item	DISC. CODE
10505875	Combination Plier 6"/150mm	5706915058758	25	5	11.62	13.94	IR (HT)
1910231	Combination Plier 7"/175mm	5706919102310	25	5	12.90	15.48	
10505876	Combination Plier 8"/200mm	5706915058765	25	5	14.20	17.04	

DIAGONAL PLIERS

Item No.	Description	EAN	Master Pack	Shelf Pack	LP Ex VAT £ / Item	RRP Inc VAT £ / Item	DISC. CODE
10505493	Diagonal Cutting Pliers 6"/150mm	5706915054934	25	5	9.02	10.82	IR (HT)
10505494	Diagonal Cutting Pliers 7"/175mm	5706915054941	25	5	10.32	12.38	
10505495	Diagonal Cutting Pliers 8"/200mm	5706915054958	25	5	11.62	13.94	

END CUTTING PLIERS

Item No.	Description	EAN	Master Pack	Shelf Pack	LP Ex VAT £ / Item	RRP Inc VAT £ / Item	DISC. CODE
10505517	End Cutting Pliers 8"/200mm	5706915055177	25	5	12.90	15.48	IR (HT)
10505518	Cable Cutter 8"/200mm	5706915055184	25	5	12.90	15.48	

LONG NOSE PLIERS

Item No.	Description	EAN	Master Pack	Shelf Pack	LP Ex VAT £ / Item	RRP Inc VAT £ / Item	DISC. CODE
10505503	Long Nose Pliers 6"/150mm	5706915055030	25	5	9.02	10.82	IR (HT)
10505504	Long Nose Pliers 8"/200mm	5706915055047	25	5	10.32	12.38	

BENT NOSE PLIERS

Item No.	Description	EAN	Master Pack	Shelf Pack	LP Ex VAT £ / Item	RRP Inc VAT £ / Item	DISC. CODE
10505505	Bent Nose Pliers 6"/150mm	5706915055054	25	5	9.02	10.82	IR (HT)
10505506	Bent Nose Pliers 8"/200mm	5706915055061	25	5	10.32	12.38	

NIPPER PLIERS

Item No.	Description	EAN	Master Pack	Shelf Pack	LP Ex VAT £ / Item	RRP Inc VAT £ / Item	DISC. CODE
10508153	Nipper Plier TG 6"/150mm	5706915081534	25	5	8.27	9.92	IR (HT)
10508152	Nipper Plier TG 7"/175mm	5706915081527	25	5	9.29	11.15	
10508151	Nipper Plier TG 8"/200mm	5706915081534	25	5	10.73	12.88	

CONSTRUCTION NIPPERS

Item No.	Description	EAN	Master Pack	Shelf Pack	LP Ex VAT £ / Item	RRP Inc VAT £ / Item	DISC. CODE
10508154	Construction Nippers TG 9"/225mm	5706915081541	25	5	12.09	14.51	IR (HT)
10508155	Construction Nippers 9"/225mm, No Grip	5706915081558	25	5	11.94	14.33	

Multi-grip jaws Groove direction 
Protouch™ grips are moulded for comfort and provide less hand fatigue
Induction Hardened
Cutting face to stay sharper, longer
Cable cutter up to Ø 1,6mm cables
Chromium Nickel steel for improved durability on the gripping and cutting face



TRADITIONAL PLIERS

All Products on this page are TÜV/GS certified for optimal safety and user confidence.



NAIL PULLERS

Item No.	Description	EAN	Master Pack	Shelf Pack	LP Ex VAT £ / Item	RRP Inc VAT £ / Item	DISC. CODE
10508156	Nail Puller TG 10"/250mm	5706915081565	25	5	12.67	15.20	IR (HT)
10508157	Nail Puller TG 8"/200mm	5706915081572	25	5	11.02	13.22	

ADJUSTABLE WRENCHES

IRWIN® VISE-GRIP® wrenches have scales in metric and imperial with ProTouch™ Grip for added comfort. TÜV/GS approvals demonstrate the high manufacturing standards of the VISE-GRIP® sub-brand. Parallel jaws with smooth surfaces assist a secure grip and helps prevent scratches.



Item No.	Description	Capacity	EAN	Master Pack	Shelf Pack	LP Ex VAT £ / Item	RRP Inc VAT £ / Item	DISC. CODE
10505486	Adjustable Wrench PTG 6"/150mm	1"/25mm	5706915054866	25	5	9.02	10.82	IR (HT)
10505488	Adjustable Wrench PTG 8"/200mm	1-1/8" / 28mm	5706915054880	25	5	10.32	12.38	
10505490	Adjustable Wrench PTG 10"/250mm	1-1/4" / 31mm	5706915054903	25	5	12.28	14.74	
10505492	Adjustable Wrench PTG 12"/300mm	1-1/2" / 38mm	5706915054927	20	5	15.50	18.60	
10508161	Adjustable Wrench Steel Handle 6"/150mm	1" / 25mm	5706915081619	20	5	9.02	10.82	
10508160	Adjustable Wrench Steel Handle 8"/200mm	1-1/8" / 28mm	5706915081602	20	5	10.32	12.38	
10508159	Adjustable Wrench Steel Handle 10"/250mm	1-1/4" / 31mm	5706915081596	20	5	12.28	14.74	
10508158	Adjustable Wrench Steel Handle 12"/300mm	1-1/2" / 38mm	5706915081589	20	5	15.50	18.60	

TRADITIONAL PLIER SET



Item No.	Description	EAN	Master Pack	Shelf Pack	LP Ex VAT £ / Item	RRP Inc VAT £ / Item	DISC. CODE
10505483	ProPliers 3pcs Set (6"/150mm diagonal cutter, 8"/200mm long nose plier, 7"/175mm combination plier)	5706915054835	5	5	32.24	38.69	IR (HT)



All Products on this page are TÜV/GS certified for optimal safety and user confidence.

VDE PLIERS

IRWIN® Vise-Grip® VDE Pliers are fully TÜV, GS and VDE certified, meaning they are guaranteed safe for working with electrical equipment up to AC 1000V or DC 1500V. Induction hardened cutting edges stay sharp longer. Machined jaws for maximum gripping strength. ProTouch™ grips provide extra comfort for less hand fatigue.

VDE COMBINATION PLIERS



Multi-grip jaws Groove direction 
Protouch™ grips are moulded for comfort and provide less hand fatigue
Induction Hardened
Cutting face to stay sharper, longer
Cable cutter up to Ø 1.6mm cables
Chromium Nickel steel for improved durability on the gripping and cutting face

Item No.	Description	EAN	Master Pack	Shelf Pack	LP Ex VAT £ / Item	RRP Inc VAT £ / Item	DISC. CODE
10505872	VDE Combination Pliers 6"/150mm	5706915058727	25	5	16.34	19.61	IR (HT)
10505873	VDE Combination Pliers 7"/175mm	5706915058734	25	5	17.60	21.12	
10505874	VDE Combination Pliers 8"/200mm	5706915058741	25	5	18.87	22.64	

VDE LONG AND BENT NOSE PLIERS

Thin nose profile gets into tight spaces, easy to reach around obstructions.

Item No.	Description	EAN	Master Pack	Shelf Pack	LP Ex VAT £ / Item	RRP Inc VAT £ / Item	DISC. CODE
10505868	VDE Long Nose Pliers 6"/150mm	5706915058680	25	5	16.34	19.61	IR (HT)
10505869	VDE Long Nose Pliers 8"/200mm	5706915058697	25	5	18.87	22.64	
10505870	VDE Bent Nose Pliers 8"/200mm	5706915058703	25	5	18.87	22.64	

VDE DIAGONAL CUTTING PLIERS

Item No.	Description	EAN	Master Pack	Shelf Pack	LP Ex VAT £ / Item	RRP Inc VAT £ / Item	DISC. CODE
10505865	VDE Diagonal Cutting Pliers 6"/150mm	5706915058659	25	5	16.34	19.61	IR (HT)
10505866	VDE Diagonal Cutting Pliers 7"/175mm	5706915058666	25	5	17.60	21.12	
10505867	VDE Diagonal Cutting Pliers 8"/200mm	5706915058673	25	5	18.87	22.64	

VDE WIRE STRIPPER

V-shape Cutters, easy and precise wire stripping up to Ø 1.6 mm cables. Induction hardened cutting edges stay sharp longer.

Item No.	Description	EAN	Master Pack	Shelf Pack	LP Ex VAT £ / Item	RRP Inc VAT £ / Item	DISC. CODE
10505871	VDE Wire Strippers 6"/150mm	5706915058710	25	5	17.60	21.12	IR (HT)

VDE PLIERS SET

Item No.	Description	EAN	Master Pack	Shelf Pack	LP Ex VAT £ / Item	RRP Inc VAT £ / Item	DISC. CODE
10505519	3pcs Set (6"/150mm diagonal cutter, 8"/200mm long nose plier, 7"/175mm combination plier)	05706915055191	5	5	52.80	63.36	IR (HT)



VDE PLIERS

What is TÜV & GS?

- Guaranteed Safety to DIN Standards
- Proven Quality & Reliability

What is VDE?

- Safely working with electrical equipment up to AC 1000Volt or DC1500Volt

All Products on this page are TÜV/GS certified for optimal safety and user confidence.



IRWIN®

Record.



PIPE WRENCHES

IRWIN® Record® offer a full range of plumbing tools designed to get the job done quickly and efficiently. From our solid-forged Stillson Wrenches to the lightweight Quick-Wrench, our range of pipe tools offer superior grip due to the unique 'V-shaped' tooth profile.

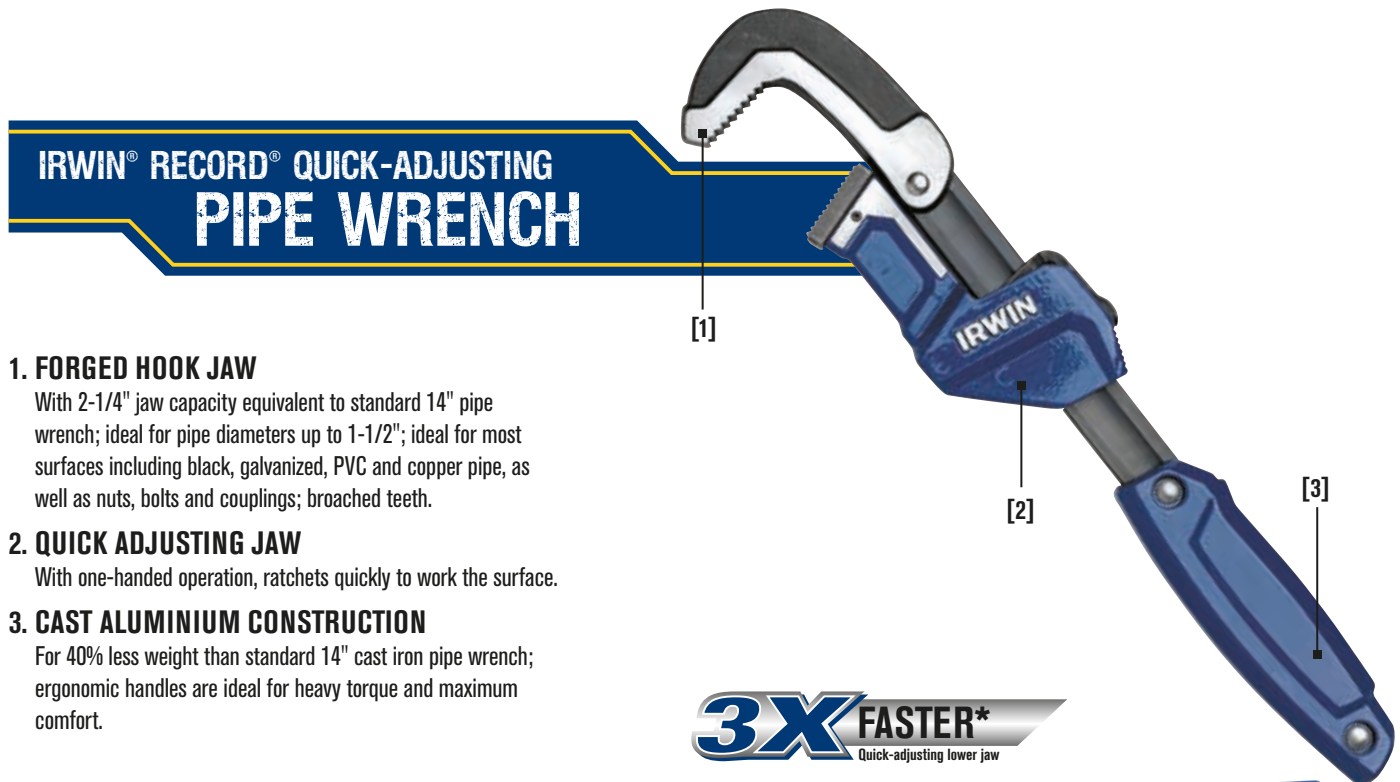

1. FORGED HOOK JAW

With 2-1/4" jaw capacity equivalent to standard 14" pipe wrench; ideal for pipe diameters up to 1-1/2"; ideal for most surfaces including black, galvanized, PVC and copper pipe, as well as nuts, bolts and couplings; broached teeth.

2. QUICK ADJUSTING JAW

With one-handed operation, ratchets quickly to work the surface.

3. CAST ALUMINIUM CONSTRUCTION

For 40% less weight than standard 14" cast iron pipe wrench; ergonomic handles are ideal for heavy torque and maximum comfort.

3X FASTER*
Quick-adjusting lower jaw

Item No.	Description	Capacity	EAN	Master Pack	Shelf Pack	LP Ex VAT £ / Item	RRP Inc VAT £ / Item	DISC. CODE
10503642	Quick-Adjusting Wrench	3 - 58mm	5706915036428	-	5	28.84	34.61	IR (HT)
10504281	Quick-Adjusting Wrench in Display of 5	3 - 58mm	5706915036428	-	5	28.15	33.78	

STILLSON PIPE WRENCHES

Item No.	Description	Capacity	EAN	Master Pack	Shelf Pack	LP Ex VAT £ / Item	RRP Inc VAT £ / Item	DISC. CODE
T3008	Stillson Wrench 8"/200mm	3/4" (19mm)	0734442111122	-	6	25.06	30.07	RI
T30010	Stillson Wrench 10"/250mm	1" (25mm)	0734442111368	-	6	28.44	34.13	
T30012	Stillson Wrench 12"/300mm	1-1/4" (32mm)	0734442111603	-	6	34.88	41.86	
T30014	Stillson Wrench 14"/350mm	1-1/2" (38mm)	0734442111849	-	6	38.12	45.74	
T30018	Stillson Wrench 18"/450mm	2" (51mm)	0734442111962	-	4	55.40	66.48	
T30024	Stillson Wrench 24"/600mm	2-1/2" (63mm)	0734442112082	-	1	105.56	126.67	
T30036	Stillson Wrench 36"/900mm	3-1/2" (89mm)	0734442112204	-	1	219.42	263.30	

STILLSON WRENCHES SPARE PARTS

Item No.	Description	Capacity	EAN	Master Pack	Shelf Pack	LP Ex VAT £ / Item	RRP Inc VAT £ / Item	DISC. CODE
T30018A	Jaw Complete with Nut (F)	0734442120605	-	1	4	42.63	51.16	IR (HT)
T30036A	Jaw Complete with Nut (F)	0734442121800	-	1	4	91.67	110.00	
T30018C	Frame with Pin (D) & Coil Spring (E)	0734442120841	-	1	4	22.04	26.45	
T30036C	Frame with Pin (D) & Coil Spring (E)	0734442122043	-	1	4	58.60	70.32	
T30024F	Nut (New Thread)	0734442117728	-	1	4	12.17	14.60	
T30036F	Nut	0734442119883	-	1	1	14.17	17.00	

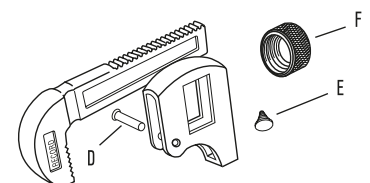

* Than traditional pipe wrenches

LEADER PIPE WRENCHES



Item No.	Description	Capacity	EAN	Master Pack	Shelf Pack	LP Ex VAT £ / Item	RRP Inc VAT £ / Item	DISC. CODE
T3508	Leader Wrench 8"/200mm	1" (25mm)	0734442112440	-	4	21.53	25.84	RI
T35010	Leader Wrench 10"/250mm	1-1/2" (38mm)	0734442112563	-	4	26.81	32.17	
T35012	Leader Wrench 12"/300mm	2" (51mm)	0734442112327	-	4	29.03	34.84	
T35014	Leader Wrench 14"/350mm	2" (51mm)	0734442112686	-	4	72.17	86.60	
T35018	Leader Wrench 18"/450mm	2-1/2" (63mm)	0734442112808	-	4	97.48	116.98	
T35024	Leader Wrench 24"/600mm	3" (76mm)	0734442112921	-	1	131.74	158.09	
T35036	Leader Wrench 36"/900mm	5" (127mm)	0734442113041	-	1	273.25	327.90	
T35048	Leader Wrench 48"/1220mm	6" (152mm)	0734442113065	-	1	435.61	522.73	

LEADER WRENCHES SPARE PARTS

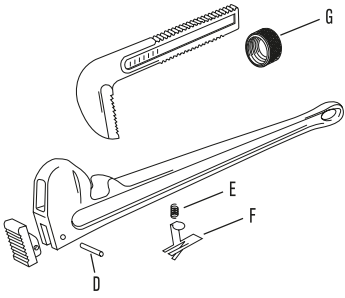

Item No.	Description	EAN	Master Pack	Shelf Pack	LP Ex VAT £ / Item	RRP Inc VAT £ / Item	DISC. CODE
T35018A	Hook Jaw c/w Nut (G)	0734442125280	-	1	48.91	58.69	IR (HT)
T35024A	Hook Jaw c/w Nut (G)	0734442126126	-	1	79.91	95.89	
T35036A	Hook Jaw c/w Nut (G)	0734442126966	-	1	155.22	186.26	
T35048A	Hook Jaw c/w Nut (G)	0734442127802	-	1	280.95	337.14	
T35010C	Handle Jaw with Pin (D)	0734442123842	-	1	7.02	8.42	
T35018C	Handle Jaw with Pin (D)	0734442125402	-	1	31.27	37.52	
T35024C	Handle Jaw with Pin (D)	0734442126249	-	1	32.21	38.65	
T35036C	Handle Jaw with Pin (D)	0734442127086	-	1	47.29	56.75	
T35048C	Handle Jaw with Pin (D)	0734442127925	-	1	52.18	62.62	
T35010E	Coil Spring (E) & Flat Spring (F)	0734442124085	-	1	4.22	5.06	

HANDIWRENCH

Chain pipe wrenches are mainly used in confined spaces, such as against a wall or close to a nest of other piping. Simply loop the chain around the pipe, lock it and the jaws will grip in the direction of the turn. The pipe can then be easily tightened or loosened with short strokes of the handle.



Item No.	Description	Capacity	EAN	Master Pack	Shelf Pack	LP Ex VAT £ / Item	RRP Inc VAT £ / Item	DISC. CODE
T240	Handi-wrench Ø100	4" (101mm)	0734442113522	48	4	40.13	48.16	RI

CHAIN PIPE WRENCHES



Item No.	Description	Capacity	EAN	Master Pack	Shelf Pack	LP Ex VAT £ / Item	RRP Inc VAT £ / Item	DISC. CODE
T23112	Chain Pipe Wrench Ø61mm/14"	5/16" - 2", (8-51mm)	0734442109082	12	1	124.29	149.15	RI
T23212	Chain Pipe Wrench Ø90mm/21-1/2"	5/16" - 3", (8-76mm)	0734442109204	12	1	205.52	246.62	
T233C	Chain Pipe Wrench Ø115mm/36"	1/2" - 4", (13-101mm)	0734442113164	6	1	285.27	342.32	
T234C	Chain Pipe Wrench Ø220mm/51"	1" - 8", (25-203mm)	0734442113287	6	1	553.23	663.88	
T235C	Chain Pipe Wrench 64-1/2"	2" - 12" (50 - 300mm)	0734442114000	6	1	774.45	929.34	

CHAIN PIPE WRENCHES - 2004 ONWARDS, SOLID-FORGED HANDLE

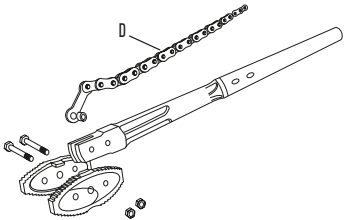

Item No.	Description	EAN	Master Pack	Shelf Pack	LP Ex VAT £ / Item	RRP Inc VAT £ / Item	DISC. CODE
T233CDB	Chain with Bush (D)	0734442113881	-	1	51.94	62.33	IR (HT)
T234CDB	Chain with Bush (D)	0734442114246	-	1	127.10	152.52	
T235CDB	Chain with Bush (D)	0734442114123	-	1	199.98	239.98	

'T' HANDLE HEX KEYS

Manufactured from high-strength and durable chrome vanadium steel. Ergonomic design to ease gripping and handling, improving the torque performance. Routed tip finish for better gripping and holding of screws. Special surface treatment to prevent oxidation and corrosion.

ProTouch™
GRIPS

HIGH TORQUE
Extra end on the handle



PROTOUCH™ GRIPS
For comfort and control

Chrome Vanadium Steel CrV3
High-resistant heat treatment
Oxided
Slot machined
TPR handle high-resistant



'T' HANDLE HEX KEY SETS

Item No.	Description	EAN	Master Pack	Shelf Pack	LP Ex VAT £ / Item	RRP Inc VAT £ / Item	DISC. CODE
T10771	8pc Set MM: 2.0, 2.5, 3.0, 4.0, 5.0, 6.0, 8.0, 10.0 mm	7897095029299	3	3	31.86	38.23	IR (HT)



HEX KEYS



HOLSTER HEX KEYS SET



Item No.	Description	EAN	Master Pack	Shelf Pack	LP Ex VAT £ / Item	RRP Inc VAT £ / Item	DISC. CODE
T10755	Short Hex Key - MM: 1.5, 2.0, 2.5, 3.0, 4.0, 5.0, 6.0, 7.0, 8.0, 10.0mm	7897095029138	-	6	11.21	13.45	IR (HT)
T10756	Long Hex Key - MM: 1.5, 2.0, 2.5, 3.0, 4.0, 5.0, 6.0, 7.0, 8.0, 10.0mm	7897095029145	-	6	16.67	20.00	
T10757	Ball-Ended Hex Key - MM: 1.5, 2.0, 2.5, 3.0, 4.0, 5.0, 6.0, 7.0, 8.0, 10.0 mm	7897095029152	-	6	17.32	20.78	
T10758	Torx Key: T6, T7, T8, T10, T15, T20, T25, T27, T30, T40	7897095029169	-	6	14.76	17.71	



HEX AND TORX KEYS - FOLD UP SETS



Retractable set of IRWIN® Hex and Torx keys housed in a high-resistance, polyamide and fiberglass handle. Ergonomic rubber grip for great comfort and ease of use. Keys are manufactured from black oxide chrome vanadium steel. Includes Hex, Ball-ended or Torx keys.

Item No.	Description	EAN	Master Pack	Shelf Pack	LP Ex VAT £ / Item	RRP Inc VAT £ / Item	DISC. CODE
T10765	Hex Key - MM: 2.0, 2.5, 3.0, 4.0, 5.0, 6.0, 8.0 mm	7897095029237	-	6	8.47	10.16	IR (HT)
T10767	Torx Key: T9, T10, T15, T20, T25, T27, T30, T40	7897095029251	-	6	10.11	12.13	
T10769	Ball - Ended Hex Key - MM: 2.0, 2.5, 3.0, 4.0, 5.0, 6.0, 8.0 mm	7897095029275	-	6	9.70	11.64	
T10768	Ball - Ended Hex Key - IMPERIAL: 9pc. 5/64" - 1/4"	7897095029268	-	6	10.06	12.07	

STANDARD HEX KEY SETS



Item No.	Description	EAN	Master Pack	Shelf Pack	LP Ex VAT £ / Item	RRP Inc VAT £ / Item	DISC. CODE
T10745	Short Hex Key - IMPERIAL: 9pc. 1/16" - 3/8"	7897095029039	-	5	7.43	8.92	
T10747	Ball-Ended Hex Key - IMPERIAL: 9pc. 1/16" - 3/8"	7897095029053	-	5	11.54	13.85	



HACKSAW BLADES

Improved cutting performance with the use of IRWIN® high-quality hacksaw blades. New tooth geometry provides higher resistance against tooth strippage and increases longevity & durability. Leveraging the advantages of the WeldTec™ platform IRWIN® hacksaw blades enable faster, smoother and less tiring cutting.

BI-METAL HACKSAW BLADES

1. WELDTEC TECHNOLOGY

Innovative tooth geometry withstands wear and keeps the blade sharp for a long time.

2. BI-METAL CONSTRUCTION

Prevents blades from shattering and delivers long blade life.



Item No.	Description	EAN	Master Pack	Shelf Pack	LP Ex VAT £ / Item	RRP Inc VAT £ / Item	DISC. CODE
10504523	Bi-Metal Hacksaw Blade 18TPI, 300mm, 2 pcs.	5706915045239	90	1	5.07	6.08	IR (HT)
10504524	Bi-Metal Hacksaw Blade 24TPI, 300mm, 2 pcs.	5706915045246	90	1	5.07	6.08	
10504525	Bi-Metal Hacksaw Blade 32TPI, 300mm, 2 pcs.	5706915045253	90	1	5.07	6.08	
10507929	Bi-Metal Hacksaw Blade 3pk (one each 18, 24 & 32TP), 300mm	5706915079296	150	1	6.88	8.26	
10505897	Bi-Metal Hacksaw Blade 18TPI, 300mm, 10 pcs.	5706915058970	50	1	24.08	28.90	
10505898	Bi-Metal Hacksaw Blade 24TPI, 300mm, 10 pcs.	5706915058987	50	1	24.08	28.90	
10505899	Bi-Metal Hacksaw Blade 32TPI, 300mm, 10 pcs.	5706915058994	50	1	24.08	28.90	
10504520	Bi-Metal Hacksaw Blade 18TPI, 300mm, 100 pcs.	5706915045208	5	1	258.10	309.72	
10504521	Bi-Metal Hacksaw Blade 24TPI, 300mm, 100 pcs.	5706915045215	5	1	258.10	309.72	
10504522	Bi-Metal Hacksaw Blade 32TPI, 300mm, 100 pcs.	5706915045222	5	1	258.10	309.72	
10504530	Junior Wood Blade 14TPI, 150mm, 10 pcs.	5706915045307	10	1	5.29	6.35	
10504531	Junior Metal Blade 32TPI, 150mm, 10 pcs.	5706915045314	10	1	5.29	6.35	

HACKSAW FRAMES

The IRWIN® Hacksaw frames are built to meet the professional's demanding needs. The durable IRWIN® frames make cutting quick and easy.

I - 125 HIGH-TENSION HACKSAW (125KG/25000 PSI)

The IRWIN® heavy-duty hacksaw frame is able to reach over 125kg blade tension to ensure accurate cutting. The soft-touch handle gives professionals a solid and slip-free grip.



Ergonomic Metal Frame for higher blade tension preventing the blade being released when dropped

Metal Tensioning Mechanism for a longer lasting tool

Soft Touch Handles ensure a comfortable sawing grip and prevents slippage

Blade Storage no need to search for spare blades

90°-55° Blade Mounting for sawing large objects

Jab-Saw for sawing in confined spaces



Item No.	Description	EAN	Master Pack	Shelf Pack	LP Ex VAT £ / Item	RRP Inc VAT £ / Item	DISC CODE
10504407	I-125 Hacksaw for 300mm blades	5706915044072	10	10	22.53	27.04	IR (AT)



I - 75 LOW TENSION HACKSAW (75KG/15000 PSI)

Item No.	Description	EAN	Master Pack	Shelf Pack	LP Ex VAT £ / Item	RRP Inc VAT £ / Item	DISC CODE
10506437	I-75 Low-Tension Hacksaw for 300mm blades	5706915064377	10	10	16.89	20.27	IR (AT)



MINI HACKSAW

Ergonomic handle for secure and comfortable cutting. Optimised for work in confined places.

Item No.	Description	EAN	Master Pack	Shelf Pack	LP Ex VAT £ / Item	RRP Inc VAT £ / Item	DISC CODE
10504408	Mini Hacksaw, 250mm blade	5706915044089	60	5	9.00	10.80	IR (AT)



JUNIOR HACKSAW

Item No.	Description	EAN	Master Pack	Shelf Pack	LP Ex VAT £ / Item	RRP Inc VAT £ / Item	DISC CODE
10504409	Junior Hacksaw	5706915044096	60	5	7.87	9.44	IR (AT)



HACKSAWS

BOLT CUTTERS

IRWIN® Record® bolt cutters made their debut in 1923. IRWIN® Record® bolt cutters combine specially formulated steel jaws and exacting manufacturing techniques to make a range of cutters that will handle high, low and medium tensile materials of all kinds.

HEAVY-DUTY ARM-ADJUSTED DROP FORGED HANDLES – CENTRE CUT

Designed to withstand the most extreme situations, high-tensile drop-forged steel jaws plus two-stage heat and ground jaws significantly increase durability and offer a stable cut capacity. Drop-forged steel handles provide safety and reliability and offer you optimal performance for cutting high-tensile material.

- Each jaw is progressively heat treated to give a penetrating cutting edge and resilient body
- Jaws are drop-forged from a specially formulated steel machined to precise specifications
- Compound action supplies 80lbs of force for every 1lb applied to the handles
- Drop-forged steel handles
- Safety stops prevent trapped fingers



Item No.	Description	EAN	Master Pack	Shelf Pack	LP Ex VAT £ / Item	RRP Inc VAT £ / Item	DISC. CODE
T914H	Arm Adjusted Bolt Cutters 14" / 355mm	0734442089162	10	1	119.93	143.92	RI
T918H	Arm Adjusted Bolt Cutters 18" / 460mm	0734442087489	10	1	147.57	177.08	
T924H	Arm Adjusted Bolt Cutters 24" / 610mm	0734442134046	4	1	182.36	218.83	
T930H	Arm Adjusted Bolt Cutters 30" / 760mm	0734442092643	2	1	219.69	263.63	
T936H	Arm Adjusted Bolt Cutters 36" / 915mm	0734442092766	2	1	303.12	363.74	
T942H	Arm Adjusted Bolt Cutters 42" / 1070mm	0734442092889	1	1	407.92	489.50	

MEDIUM-DUTY CAM-ADJUSTED DROP FORGED HANDLES – CENTRE CUT

The cam adjusted bolt cutters are perfect for medium duty work on a daily basis. The drop-forged steel handles provide safe and reliable action along with specially formulated and heat-treated induction hardened steel heads.



Item No.	Description	EAN	Master Pack	Shelf Pack	LP Ex VAT £ / Item	RRP Inc VAT £ / Item	DISC. CODE
TBC914H	Cam Adjusted Bolt Cutters 14" / 355mm	0734442090847	10	1	91.90	110.28	RI
TBC918H	Cam Adjusted Bolt Cutters 18" / 460mm	0734442092407	10	1	111.13	133.36	
TBC924H	Cam Adjusted Bolt Cutters 24" / 610mm	0734442092520	4	1	153.04	183.65	
TBC930H	Cam Adjusted Bolt Cutters 30" / 760mm	0734442092667	3	1	191.12	229.34	
TBC936H	Cam Adjusted Bolt Cutters 36" / 915mm	0734442092780	2	1	263.72	316.46	

GENERAL PURPOSE CAM-ADJUSTED TUBULAR HANDLES – CENTRE CUT

The cam adjusted high-tensile tubular handled bolt cutter are lightweight and easy to maintain. Great for help around the workshop, farm or garage.



Item No.	Description	EAN	Master Pack	Shelf Pack	LP Ex VAT £ / Item	RRP Inc VAT £ / Item	DISC. CODE
TTBC914	Cam Adjusted Tubular Handled Bolt Cutters 14" / 355mm	0734442089834	10	1	80.88	97.06	RI
TTBC918	Cam Adjusted Tubular Handled Bolt Cutters 18" / 460mm	0734442089841	8	1	97.81	117.37	
TTBC924	Cam Adjusted Tubular Handled Bolt Cutters 24" / 610mm	0734442089858	6	1	134.67	161.60	
TTBC930	Cam Adjusted Tubular Handled Bolt Cutters 30" / 760mm	0734442089896	4	1	168.19	201.83	
TTBC936	Cam Adjusted Tubular Handled Bolt Cutters 36" / 915mm	0734442089902	3	1	232.07	278.48	

MEDIUM-DUTY CAM-ADJUST DROP FORGED HANDLES – END CUT

Designed for close cropping low-tensile and non-ferrous materials in confined spaces.



Item No.	Description	EAN	Master Pack	Shelf Pack	LP Ex VAT £ / Item	RRP Inc VAT £ / Item	DISC. CODE
TBC924E	Cam Adjusted Bolt Cutter -End Cut 24"/610 mm	0734442093008	6	1	233.12	279.74	RI

MEDIUM-DUTY COMPACT CUTTER

Drop-forged steel jaws and double fulcrum action give a maximum capacity of \varnothing 4.0 mm soft steel or \varnothing 1.5 mm hard steel wire. Spring-loaded pressed-steel handles for single hand operation.

Item No.	Description	EAN	Master Pack	Shelf Pack	LP Ex VAT £ / Item	RRP Inc VAT £ / Item	DISC. CODE
T909	Medium-Duty Compact Cutter 9"/225mm	0734442090601	60	4	43.98	52.78	RR



MEDIUM-DUTY CABLE CUTTERS

Drop-forged steel heads with long tubular handles for cutting a variety of wire and cable.

Item No.	Description	EAN	Master Pack	Shelf Pack	LP Ex VAT £ / Item	RRP Inc VAT £ / Item	DISC. CODE
TWC6	Spring Handle Wire Cutter for Small, Solid and Strand Wire	5011117175609	6	1	43.69	52.43	RI
TWC16	Up to 16 mm Wire Rope & 21mm OD Armoured Electric Cable	0734442175704	10	1	145.33	174.40	
TCC26	Up to 26 mm Un-Armoured Copper & Aluminium Cable	0734442176008	10	1	121.23	145.48	



REPLACEMENT JAWS - CENTRE CUT

Item No.	Description	EAN	Master Pack	Shelf Pack	LP Ex VAT £ / Item	RRP Inc VAT £ / Item	DISC. CODE
TJ914H	Replacement Jaw - Center Cut, Fits 14"/355mm Bolt Cutters	0734442094579	-	1	49.46	59.35	RR
TJ918H	Replacement Jaw - Center Cut, Fits 18"/460mm Bolt Cutters	0734442096009	-	1	59.03	70.84	
TJ924H	Replacement Jaw - Center Cut, Fits 24"/610mm Bolt Cutters	0734442096122	-	1	67.83	81.40	
TJ930H	Replacement Jaw - Center Cut, Fits 30"/760mm Bolt Cutters	0734442096245	-	1	90.69	108.83	
TJ936H	Replacement Jaw - Center Cut, Fits 36"/915mm Bolt Cutters	0734442096368	-	1	93.94	112.73	
TJ942H	Replacement Jaw - Center Cut, Fits 42"/1070mm Bolt Cutters	0734442096481	-	1	164.60	197.52	



REPLACEMENT JAWS - CLIPPER CUT

Item No.	Description	EAN	Master Pack	Shelf Pack	LP Ex VAT £ / Item	RRP Inc VAT £ / Item	DISC. CODE
TJ914F	Replacement Jaw - Clipper Cut, Fits 14"/355mm Bolt Cutters	0734442094562	-	1	56.00	67.20	RR
TJ918F	Replacement Jaw - Clipper Cut, Fits 18"/460mm Bolt Cutters	0734442094685	-	1	60.72	72.86	
TJ924F	Replacement Jaw - Clipper Cut, Fits 24"/610mm Bolt Cutters	0734442094807	-	1	72.26	86.71	
TJ930F	Replacement Jaw - Clipper Cut, Fits 30"/760mm Bolt Cutters	0734442094920	-	1	92.74	111.29	



REPLACEMENT JAWS - END CUT

Item No.	Description	EAN	Master Pack	Shelf Pack	LP Ex VAT £ / Item	RRP Inc VAT £ / Item	DISC. CODE
TJ924E	Replacement Jaw - End Cut, Fits item TBC924E	0734442097204	-	1	117.89	141.47	RR



REPLACEMENT STRAP SETS

Item No.	Description	EAN	Master Pack	Shelf Pack	LP Ex VAT £ / Item	RRP Inc VAT £ / Item	DISC. CODE
T914UEFGT	Replacement Strap Set, Fits 14"/355mm Bolt Cutters	0734442097938	-	1	11.18	13.42	RI
T918UEFGT	Replacement Strap Set, Fits 18"/460mm Bolt Cutters	0734442098058	-	1	11.68	14.02	
T924UEFGT	Replacement Strap Set, Fits 24"/610mm Bolt Cutters	0734442098652	-	1	13.38	16.06	
T930UEFGT	Replacement Strap Set, Fits 30"/760mm Bolt Cutters	0734442110057	-	1	16.10	19.32	
T936UEFGT	Replacement Strap Set, Fits 36"/915mm Bolt Cutters	0734442114857	-	1	18.81	22.57	
T942UEFGT	Replacement Strap Set, Fits 42"/1070mm Bolt Cutters	0734442108979	-	1	21.93	26.32	



FASTENER KITS

Item No.	Description	EAN	Master Pack	Shelf Pack	LP Ex VAT £ / Item	RRP Inc VAT £ / Item	DISC. CODE
T914KIT	Fastener Kit for item T914H	0734442097945	-	1	31.48	37.78	IR (HT)
T918KIT	Fastener Kit for item T918H	0734442089292	-	1	32.42	38.90	
T924KIT	Fastener Kit for item T924H	0734442098669	-	1	36.55	43.86	
T930KIT	Fastener Kit for item T930H	0734442104773	-	1	50.85	61.02	
T936KIT	Fastener Kit for item T936H	0734442091455	-	1	65.17	78.20	
T942KIT	Fastener Kit for item T942H	0734442108917	-	1	85.21	102.25	
TBC914KIT	Fastener Kit for item TBC914H & TTBC914	0734442090977	-	1	31.18	37.42	
TBC918KIT	Fastener Kit for item TBC918H & TTBC918	0734442090984	-	1	31.18	37.42	
TBC924KIT	Fastener Kit for item TBC924H & TTBC924	0734442169673	-	1	35.20	42.24	
TBC930KIT	Fastener Kit for item TBC930H & TTBC930	0734442010043	-	1	48.85	58.62	
TBC936KIT	Fastener Kit for item TBC936H & TTBC936	0734442101444	-	1	62.67	75.20	

Fastener Kits Includes:

- 4 arm adjust screws
- 2 stud strap nuts
- 2 stud strap washers
- 1 handle connecting pin
- 1 handle connecting clip
- 2 handle connecting bolts,
- 2 handle connecting nuts
- 2 arm rivets
- 1 jaw center pin

SNIPS AND SHEARS

IRWIN® Gilbow® snips and shears have a cutting capability much greater than the strength of the user. The original tin snips were first designed in 1924 and have dominated the sheet metal cutting industry to such an extent that today, snips and shears are referred to as 'Gilbows'.

Unique non-slip joint set and tested for a perfect cut. This should be re-adjusted only after sharpening
Double, hollow ground blades reduce friction for easier cutting

Drop-forged carbon tool steel handles and blades
Safety stop prevents trapped fingers



GENERAL PURPOSE SNIPS



Item No.	Description	EAN	Master Pack	Shelf Pack	LP Ex VAT £ / Item	RRP Inc VAT £ / Item	DISC. CODE
TG2458	General Purpose Snips, 8"/200mm	0734442188049	36	6	17.77	21.32	RI
TG24510	General Purpose Snips, 10"/250mm	0734442188162	36	6	21.54	25.85	
TG24512	General Purpose Snips, 12"/300mm	0734442188285	36	6	24.08	28.90	
TG24514	General Purpose Snips, 14"/350mm	0734442188407	36	6	30.46	36.55	

SPRING-DIVIDED SNIPS

Made in 4 sizes for straight and off-straight cutting. Spring divided handles automatically open the snips at the end of each cut.



Item No.	Description	EAN	Master Pack	Shelf Pack	LP Ex VAT £ / Item	RRP Inc VAT £ / Item	DISC. CODE
TG245S8	Spring-Divided Snips, 8"/200mm	0734442188520	36	6	25.75	30.90	RI
TG245S10	Spring-Divided Snips, 10"/250mm	0734442188643	36	6	30.58	36.70	
TG245S12	Spring-Divided Snips, 12"/300mm	0734442188766	36	6	33.27	39.92	
TG245S14	Spring-Divided Snips, 14"/350mm	0734442188889	36	6	40.57	48.68	

CURVED BLADE SNIPS

Designed to compliment the G245 range these snips will make tight radius cuts in a clockwise or anti-clockwise direction.



Item No.	Description	EAN	Master Pack	Shelf Pack	LP Ex VAT £ / Item	RRP Inc VAT £ / Item	DISC. CODE
TG2468	Curved Blade Snips, 8"/200mm	0734442189008	48	6	31.03	37.24	RI
TG24610	Curved Blade Snips, 10"/250mm	0734442189121	48	3	32.69	39.23	
TG24612	Curved Blade Snips, 12"/300mm	0734442189244	48	3	37.77	45.32	

JEWELLERS' SNIPS

Short-bladed light-duty snips often used by jewellers, silversmiths and model makers.



Item No.	Description	EAN	Master Pack	Shelf Pack	LP Ex VAT £ / Item	RRP Inc VAT £ / Item	DISC. CODE
TG56	Jewellers' Snips, 7" Straight Blade	0734442190202	24	6	20.98	25.18	RI
TG056	Jewellers' Snips, 7" Curved Blade	0734442187929	24	6	30.40	36.48	

HEAVY-DUTY CRANKED HANDLE SHEARS

These crank-handled shears can be used for off-straight cutting. The G69 is right-hand cranked for working anti-clockwise and the G67 is left-hand cranked for working clockwise.



Item No.	Description	EAN	Master Pack	Shelf Pack	LP Ex VAT £ / Item	RRP Inc VAT £ / Item	DISC. CODE
TG67	Heavy-Duty Cranked Handle Snips, 11" Left-Handed	0734442189367	36	6	40.35	48.42	RI
TG69	Heavy-Duty Cranked Handle Snips, 11" Right-Handed	0734442189480	36	6	41.07	49.28	
TG691	Heavy-Duty Cranked Handle Snips, 14" Right-Handed	0734442189602	36	6	52.95	63.54	

MEDIUM-DUTY STRAIGHT HANDLE SHEARS



Item No.	Description	EAN	Master Pack	Shelf Pack	LP Ex VAT £ / Item	RRP Inc VAT £ / Item	DISC. CODE
TG950	Medium-Duty Straight Handle Snips, 12"/300mm	0734442189725	36	6	44.29	53.15	RI
TG69NB	Nut & Bolt for G67, G69, G950, G691	0734442195368	-	1	3.89	4.67	

AVIATION AND OFFSET SNIPS

IRWIN® Aviation and Offset Snips have precision formed blades for a longer cutting life; ergonomically designed over-moulded soft-grips for a perfect balance of comfort and performance in the hand, and a long-life torsion spring for a smooth and consistent cut.



Serrated lower blade for firmer action, smoother cut, and no double marked edges
ProTouch™ moulded soft-grips for superior comfort and control, resulting in less hand fatigue/stress
Increased length of cut for faster work
Improved balanced weight distribution for greater comfort
Drop-resistant latch for easy one-handed use, saving time & increasing safety
250mm long with a 3.34cm length of cut
Cut capacity of 1.19mm sheet metal and 0.84mm stainless steel



AVIATION SNIPS



Item No.	Description	EAN	Master Pack	Shelf Pack	LP Ex VAT £ / Item	RRP Inc VAT £ / Item	DISC. CODE
10504309N	Aviation Snip 101, Left and Straight Cut	5706915043099	-	5	16.51	19.81	IR (HT)
10504310N	Aviation Snip 102, Right and Straight Cut	5706915043105	-	5	16.51	19.81	
10504311N	Aviation Snip 103, Straight and Wide Curves	5706915043112	-	5	16.51	19.81	

BULLDOG SNIPS

225mm long with a 1.9 cm length of cut . Cut capacity of 16g/1.52 mm sheet metal and 18g/1.19 mm stainless steel

Item No.	Description	EAN	Master Pack	Shelf Pack	LP Ex VAT £ / Item	RRP Inc VAT £ / Item	DISC. CODE
10504313N	Bulldog Snip 105, Straight and Short Curves	5706915043136	-	5	19.76	23.71	IR (HT)



SNIPS

OFFSET SNIPS

240mm long with a 3.02 cm length of cut . Cut capacity of 18g/1.19 mm sheet metal and 22g/0.84 mm stainless steel

Item No.	Description	EAN	Master Pack	Shelf Pack	LP Ex VAT £ / Item	RRP Inc VAT £ / Item	DISC. CODE
10504315N	Offset Snip 20SL, Straight, Angles & Left Curves	5706915043150	-	5	21.62	25.94	IR (HT)
10504316N	Offset Snip 20SR, Straight, Angles & Right Curves	5706915043167	-	5	21.62	25.94	



EXTRA CUT SNIPS

Designed for numerous applications when a long cut in lightweight material is desired.

Item No.	Description	EAN	Master Pack	Shelf Pack	LP Ex VAT £ / Item	RRP Inc VAT £ / Item	DISC. CODE
10504314N	Extra Cut Snip 304 Cut Straight and Wide Curves	5706915043143	25	5	19.25	23.10	IR (HT)







In 1933, a young man by the name of Hans Schroder set up as a wholesaler in Copenhagen, Denmark. During the first few years he kept his focus on selling general hand tools, but in 1938 he started to also manufacture saws. Amongst his friends and business associates Hans Schroder was known simply as Jack, and before long, the "Jack" name had become synonymous with the production of high quality saws.

IRWIN® Jack® has been at the forefront of many advances with the development of the market leading Jack® 880 now with upgraded protouch handle to compliment the recently upgraded Universal triple ground technology.



Marples®

At the heart of quality craftsmanship lies the rich heritage of Marples® woodworking tools. Originating in 1828 in Sheffield, England, the Marples® brand has consistently stood for superior performance and ultimate precision in fine woodworking.

Founder William Marples came from a long lineage of master craftsmen in the joinery and edge tool trades, and after serving as an apprentice to his father he established William Marples and Sons Limited. Using only the finest materials Marples® had his name stamped into every product as a sign of his confidence in the quality and craftsmanship of each tool.



SAWS



CHISELS



WOODWORKING TOOLS



PLUS 880

EVER-RELIABLE CUTTING PERFORMANCE, IMPROVED HANDLE DESIGN

- NEW ProTouch Grip for maximum feel
- 25% faster cutting performance*
- Full Range of Fine, Universal, Coarse and Coated PLUS Handsaws Available



PLUS 880 UNIVERSAL HANDSAW

UNIVERSAL

BLADE LENGTHS - 14" / 20" / 22"



1. PATENTED UNIVERSAL TEETH

Patented Tooth Grind
Cuts Most Building Materials
8 Teeth Per Inch

2. STRONG BLADE - C75 STEEL

High-quality C75 steel is stable and ensures maximum power transfer

3. MARKING

90° & 45°

4. PROTOUCH GRIP

With three times more elastomer for maximum soft feel

5. HAND CAPACITY

Increased space for use with gloves and improved functionality

6. GRIP CIRCUMFERENCE

Increased size for sturdy and robust feel

25% FASTER*



Item No.	Description	EAN	Master Pack	Shelf Pack	LP Ex VAT £ / Item	RRP Inc VAT £ / Item	DISC. CODE
1897526	Universal 880TG, 14"/350mm 8T/9P	5706918975267	-	10	12.82	15.38	IR (HT)
10505212	Universal 880TG, 20"/500mm 8T/9P	5706915052121	-	10	13.20	15.84	
10505213	Universal 880TG, 22"/550mm 8T/9P	5706915052138	-	10	13.52	16.22	

* vs previous, double ground version

FRICION PTFE COATING

- A. Gives between 20 to 50% improvement (material dependent) when sawing
- B. Offers improved wear-resistance



Item No.	Description	EAN	Master Pack	Shelf Pack	LP Ex VAT £ / Item	RRP Inc VAT £ / Item	DISC. CODE
1897525	Universal Coated 880TG, 22"/550mm 8T/8P	5706918975250	-	10	16.33	19.60	IR (HT)

UNIVERSAL COATED

BLADE LENGTH - 22"

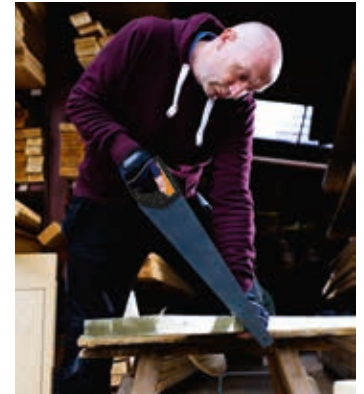

COARSE TEETH

- Patented Tooth Grind
- Double ground
- 7 Teeth Per Inch



Item No.	Description	EAN	Master Pack	Shelf Pack	LP Ex VAT £ / Item	RRP Inc VAT £ / Item	DISC. CODE
10505211	Crosscut/ Coarse 770TG, 22"/550mm 7T/8P	5706915052114	-	10	13.52	16.22	IR (HT)

COARSE

BLADE LENGTH - 22"

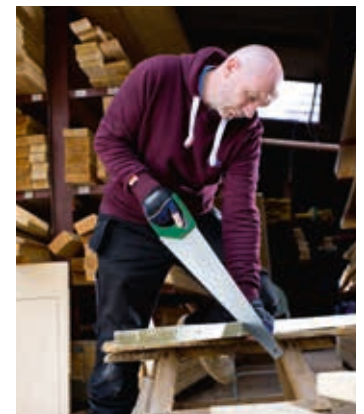

FINE TEETH

- Patented Tooth Grind
- Double Ground
- 9 Teeth Per Inch



Item No.	Description	EAN	Master Pack	Shelf Pack	LP Ex VAT £ / Item	RRP Inc VAT £ / Item	DISC. CODE
10505215	Fine 990, 22"/550mm 9T/10P	5706915052152	-	10	13.52	16.22	IR (HT)
10503632	Junior/Toolbox 99U-J, 13"/335mm 12T/13P	5706915936322	-	10	10.98	13.18	IR (HT)

FINE

BLADE LENGTH - 13" AND 22"

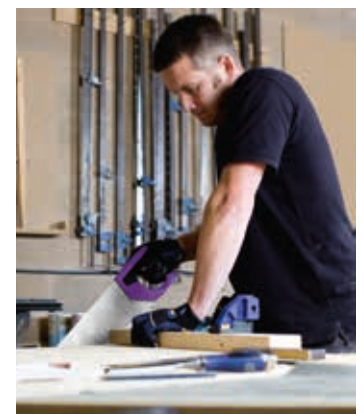

HANDSAWS

XPERT

- Triple-ground teeth** for ultimate cutting performance
- 1mm rigid blade** for maximum stability
- Deep gullets** for enhanced performance & greater volume removal of waste material (Coarse saw only)
- Fine nose teeth** for easy start (Universal and Toolbox Saw only)
- Soft-grip handle with finger guide** for maximum comfort in prolonged use
- Hard point teeth** for longer life
- High quality C75 steel blade** that is stable and ensures maximum power transfer
- Water based lacquer** gives four times better rust protection than traditional lacquer



The ultimate cutting comfort and performance of the XPERT comes from its breakthrough Triple-Ground Teeth (TGT). This technology has been developed in collaboration with the research centre of the University of Newcastle.

The TGT logo is the mark of quality for the IRWIN® Jack® tooth design.



XPERT HANDSAWS

The XPERT saw range takes wood cutting to whole new levels of comfort and performance. Designed for Professionals - The XPERT saw range has a specific saw for every material and application.



Item No.	Description	EAN	Master Pack	Shelf Pack	LP Ex VAT £ / Item	RRP Inc VAT £ / Item	DISC. CODE
10505538	Universal Toolbox 15"/375mm 8T/9P	5706915055382	-	10	14.50	17.40	IR (HT)
10505539	Universal 18"/450mm 8T/9P	5706915055399	-	4	14.89	17.87	
10505540	Universal 20"/500mm 8T/9P	5706915055405	-	4	15.85	19.02	
10505541	Universal 22"/550mm 8T/9P	5706915055412	-	4	16.94	20.33	
10505555	Fine Toolbox 15"/375mm 10T/11P	5706915055559	-	10	14.50	17.40	
10505556	Fine 20"/500mm 10T/11P	5706915055566	-	4	15.85	19.02	
10505543	Fine 22"/550mm 10T/11P	5706915055436	-	4	17.62	21.14	
10505542	Coarse with Gullets 22"/550mm 8T/9P	5706915055429	-	4	18.12	21.74	
10503530	Coarse 20"/500mm 3,5T/4P	5715110475802	-	4	15.95	19.14	
10503531	Coarse 24"/600mm 3,5T/4P	5715110427191	-	4	17.17	20.60	
10505548	Light Concrete Hardpoint Teeth 28"/700mm	5706915055481	-	4	27.02	32.42	
10505549	Light Concrete 1/2 Carbide Tipped 28"/700mm	5706915055498	-	4	57.53	69.04	
10505550	Light Concrete FULL Carbide Tipped 28"/700mm	5706915055504	-	4	138.57	166.28	

XPERT COATED HANDSAWS

The XPERT range of low-friction PTFE coated handsaws from IRWIN® give between 20 to 50% improvement (material dependent) when sawing and also offer improved wear-resistance.

Item No.	Description	EAN	Master Pack	Shelf Pack	LP Ex VAT £ / Item	RRP Inc VAT £ / Item	DISC. CODE
10505544	Universal Toolbox PTFE 15"/375mm 8T/9P	5706915055443	-	10	17.10	20.52	IR (HT)
10505545	Universal PTFE 20"/500mm 8T/9P	5706915055450	-	4	18.44	22.13	
10505546	Universal PTFE 22"/550mm 8T/9P	5706915055467	-	4	19.54	23.45	
10505602	Fine PTFE 20"/500mm 10TPI/11P	5706915056020	-	4	18.44	22.13	
10505603	Fine PTFE 22"/550mm 10TPI/11P	5706915056037	-	4	20.22	24.26	
10505547	Coarse with gullets PTFE 22"/550mm 8T/9P	5706915055474	-	4	20.83	25.00	

XPERT BOWSAWS

IRWIN® offers the complete range of bowsaws & replacement blades for pruning and garden work. Select from hard point and precision filed blades that give outstanding cutting performance, whether it's trimming storm-damaged trees, pruning shrubs, bushes or cutting firewood.

Item No.	Description	EAN	Master Pack	Shelf Pack	LP Ex VAT £ / Item	RRP Inc VAT £ / Item	DISC. CODE
TXP1120762000	Bowsaw - Dry Wood 30" / 762 mm	5706915000184	-	5	8.61	10.33	IR (HT)
TXP1624533000	Bowsaw - Green Wood 21" / 533 mm	5706915000269	-	5	8.61	10.33	
TXP1124610000	Bowsaw - Green Wood 24" / 610 mm	5706915000207	-	5	10.03	12.04	
TXP1124762000	Bowsaw - Green Wood 30" / 762 mm	5706915000221	-	5	11.48	13.78	

XPERT BOWSAW BLADES

Item No.	Description	EAN	Master Pack	Shelf Pack	LP Ex VAT £ / Item	RRP Inc VAT £ / Item	DISC. CODE
TXP3011300000	Bowsaw Blade - Dry Wood 12" / 300 mm	5715110480066	-	10	2.45	2.94	IR (HT)
TXP3020533000	Bowsaw Blade - Dry Wood 21" / 533 mm	5715110480189	-	10	2.80	3.36	
TXP3020610000	Bowsaw Blade - Dry Wood 24" / 610 mm	5715110480219	-	10	3.18	3.82	
TXP3020762000	Bowsaw Blade - Dry Wood 30" / 762 mm	5715110480240	-	10	3.54	4.25	
TXP3024533000	Bowsaw Blade - Green Wood 21" / 533 mm	5715110480271	-	10	2.80	3.36	
TXP3024610000	Bowsaw Blade - Green Wood 24" / 610 mm	5715110480332	-	10	3.18	3.82	
TXP3024762000	Bowsaw Blade - Green Wood 30" / 762 mm	5715110480301	-	10	4.26	5.11	

COMBI SAW

IRWIN® Jack® combi saw comes with a wood cutting bowsaw blade and a Bi-Metal cutting hacksaw blade making this tool universal for all cutting applications.

Item No.	Description	EAN	Master Pack	Shelf Pack	LP Ex VAT £ / Item	RRP Inc VAT £ / Item	DISC. CODE
TXP1211300000	Combi Saw, 12"/300 mm	5706915000122	-	10	9.21	11.05	GM

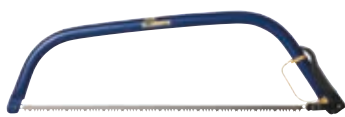

XP3011 for dry & hard wood



XP3020 for dry wood



XP3024 for green wood



The unique handle-to-blade relationship overcomes traditional design limitations and maximises how the user interacts with the handsaw. With optimal tooth design and superior ergonomics, the holistic product concept optimises handle position (height and angle) against the tooth line. Now, EVO covers virtually all user needs.



EVO HANDSAWS

Item No.	Description	EAN	Master Pack	Shelf Pack	LP Ex VAT £ / Item	RRP Inc VAT £ / Item	DISC. CODE
10507858	EVO Handsaw Universal, 525mm 10T/11P	5706915078589	-	10	16.33	19.60	IR (HT)
10507860	EVO Handsaw Universal - Short, 425mm 10T/11P	5706915078602	-	10	16.33	19.60	

High angled nose increases blade stability
Hard Point teeth (HP) stay sharp 6-8 times longer than non-hardened teeth
Optimised tooth design & set provides maximum versatility, Speed of cut & quality of cut
High quality C75 Steel blade ensures maximum stability and power transfer
Optimised product design for universal usage and highest versatility
Maximum blade usage allows up to 100% blade usage
Flush cutting to cut off at surface level
Comfort grip light and strong ultrasonic welded soft-grip handle for maximum grip and comfort
90° & 45° for marking out
Finger-rest for maximum control

SPECIALITY SAWS

IRWIN® Specialty saws help construction professionals effectively carry out trade specific jobs like cutting openings in gypsum board.



Item No.	Description	EAN	Master Pack	Shelf Pack	LP Ex VAT £ / Item	RRP Inc VAT £ / Item	DISC. CODE
10505705	ProTouch Jab Saw, 7T/8P	5706915057058	24	4	11.03	13.24	IR (HT)
T106150	Standard Jab Saw, 7T/8P	5715110421601	-	20	8.27	9.92	
10505707	Protouch Dovetail Saw with reversible handle, 10"/254mm 13T/14P	5706915057072	24	4	11.03	13.24	
T7250	Straight Dovetail Saw, 10"/250mm 13T/14P	5715110421717	-	10	5.58	6.70	
T9250	Offset Dovetail Saw, 10"/250mm 13T/14P	5715110421724	-	10	6.10	7.32	
T13250	Offset Dovetail Saw with reversible handle, 10"/250mm 13T/14P	5715110421731	-	10	8.11	9.73	
10503532	Keyhole/Pad Saw, 12"/300mm	5706915035322	-	4	9.73	11.68	
10503533	Floorboard/Veneer, 13"/325mm	5706915035339	-	4	9.11	10.93	
10507424	Tenon, 10"/250mm 12T/13P	5706915074246	-	4	10.09	12.11	
10503534	Tenon, 12"/300mm 12T/13P	5706915035346	-	4	11.02	13.22	
10503535	Tenon, 14"/350mm 12T/13P	5706915035353	-	4	14.67	17.60	

PULL SAWS

IRWIN® Pull Saws are rapidly becoming an essential tool for both the specialist woodworker and for carpenters and re-modellers. The products offers a very thin blade that is flexible for flush and difficult cuts.

Item No.	Description	EAN	Master Pack	Shelf Pack	LP Ex VAT £ / Item	RRP Inc VAT £ / Item	DISC. CODE
10505162	Pull Saw Carpenter 12"/300mm, 14TPI	5706915051629	-	4	18.77	22.52	
10505163	Pull Saw Extra Fine Cut (with spine), 19TPI	5706915051636	-	4	22.07	26.48	
10505164	Pull Saw Double Edge (rip/cross-cut), 7/17TPI	5706915051643	-	4	18.77	22.52	
10505165	Pull Saw Mini Dovetail/Detail Saw, 22TPI	5706915051650	-	4	14.57	17.48	

PRUNING SAWS

Item No.	Description	EAN	Master Pack	Shelf Pack	LP Ex VAT £ / Item	RRP Inc VAT £ / Item	DISC. CODE
TNA2059343000	Pruning Saw - Straight	5715110421632	-	6	8.80	10.56	GM
TNA2072330000	Pruning Saw - Curved	5715110421663	-	6	12.89	15.47	



HANDSAWS

IRWIN

JACK



CHISELS

IRWIN® woodworking tools embody a long tradition of craftsmanship and our chisel remains one of the finest on the market, recognised by professionals as setting the standard for all others. With many unique features developed through continuing innovation, our comprehensive range of tough, dependable chisels will tackle the most intricate or demanding job effortlessly.

MS750 HIGH-IMPACT CHISEL

1. BEST IN CATEGORY STEEL QUALITY

For improved sharpness and edge retention.

2. BLADE HARDENED AND TEMPERED

For long chisel life.

3. FULLY FORGED STEEL CORE

To better transfer energy from handle to blade.

4. PROTOUCH™ OVER-MOULD GRIP

For added comfort.

5. SPLITPROOF ACETATE HANDLE

For superior durability.

6. EXTRA LARGE STRIKE CAP

For use with hammers at different angles.

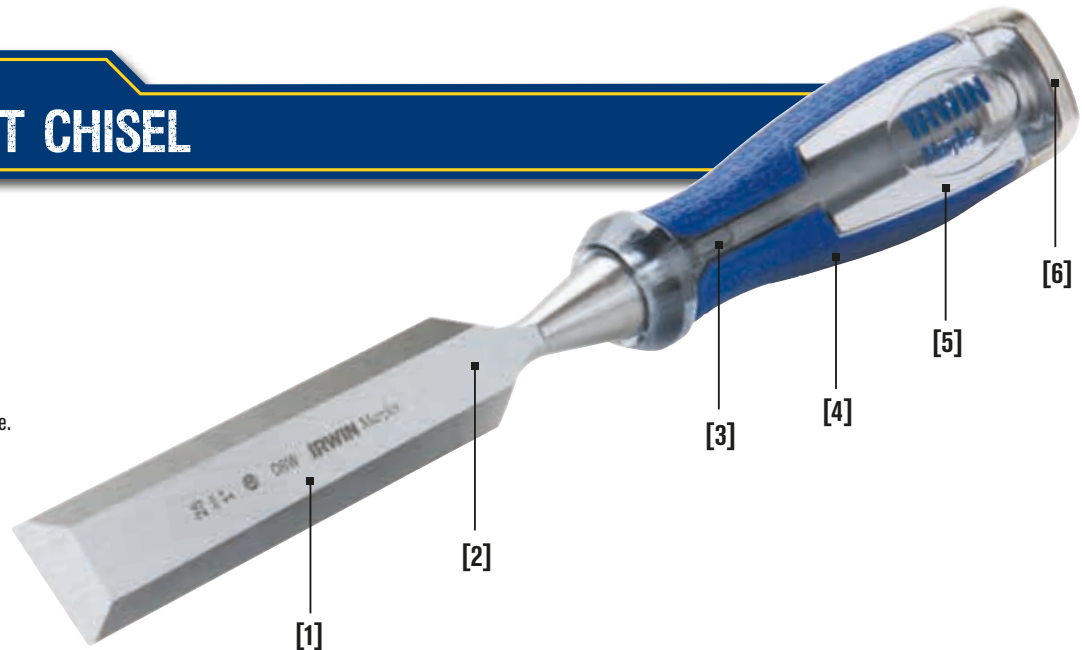

MS750 SINGLES

Item No.	Description	EAN	Master Pack	Shelf Pack	LP Ex VAT £ / Item	RRP Inc VAT £ / Item	DISC. CODE
10501671	MS750, 1/8" / 3mm	0734442201250	48	4	16.75	20.10	GM
10501673	MS750, 1/4" / 6mm	0734442201151	48	4	13.58	16.30	
10501675	MS750, 3/8" / 10mm	0734442201168	48	4	14.04	16.85	
10501677	MS750, 1/2" / 13mm	0734442201175	48	4	14.11	16.93	
10501680	MS750, 5/8" / 16mm	0734442201267	48	4	14.99	17.99	
10501682	MS750, 3/4" / 19mm	0734442201182	48	4	15.71	18.85	
10501685	MS750, 1" / 25mm	0734442201199	48	4	17.74	21.29	
10501689	MS750, 1-1/4" / 32mm	0734442201205	48	4	20.56	24.67	
10501691	MS750, 1-1/2" / 38mm	0734442201212	24	2	23.22	27.86	
10501693	MS750, 2" / 50mm	0734442201274	24	2	24.16	28.99	



MS750 SETS

Item No.	Description	EAN	Master Pack	Shelf Pack	LP Ex VAT £ / Item	RRP Inc VAT £ / Item	DISC. CODE
10503419	MS750 3 pcs Set, 1/2", 3/4", 1"	0734442201229	16	4	47.56	57.07	GM
10503421	MS750 5 pcs Set, 1/4", 3/8", 1/2", 3/4", 1" in Wallet	5706915034219	16	4	75.17	90.20	

MS751 FIRMER CHISEL

The MS751 Firmer chisel has a blade with a rectangular cross-section. This means that it is stronger and can be used for heavier work and cuts on a front edge.



Item No.	Description	EAN	Master Pack	Shelf Pack	LP Ex VAT £ / Item	RRP Inc VAT £ / Item	DISC. CODE
10501768	MS751, 1-1/8" / 28mm	5706915017687	48	4	20.98	25.18	GM

Best in category steel quality for improved sharpness and edge retention
Blade hardened and tempered for long chisel life
Splitproof Acetate Handle for superior durability
Contoured handle provides added control



M373 SPLITPROOF BEVEL EDGE CHISELS



M373 SINGLES

Item No.	Description	EAN	Master Pack	Shelf Pack	LP Ex VAT £ / Item	RRP Inc VAT £ / Item	DISC. CODE
TM37318	M373 1/8" / 3mm	0734442197768	48	4	24.54	29.45	GM
TM37314	M373 1/4" / 6mm	0734442197881	48	4	19.95	23.94	
TM37338	M373 3/8" / 10mm	0734442198000	48	4	20.73	24.88	
TM37312	M373 1/2" / 13mm	0734442198123	48	4	20.85	25.02	
TM37358	M373 5/8" / 16mm	0734442198246	48	4	22.08	26.50	
TM37334	M373 3/4" / 19mm	0734442198369	48	4	22.57	27.08	
TM3731	M373 1" / 25mm	0734442198482	48	4	23.94	28.73	
TM373114	M373 1-1/4" / 32mm	0734442198604	48	4	30.12	36.14	
TM373112	M373 1-1/2" / 38mm	0734442198727	24	2	36.85	44.22	
TM3732	M373 2" / 51mm	0734442202202	24	2	41.49	49.79	

M373 SET

Item No.	Description	EAN	Master Pack	Shelf Pack	LP Ex VAT £ / Item	RRP Inc VAT £ / Item	DISC. CODE
TM373S6	M373 6 pcs Set - 1/4", 3/8", 1/2", 3/4", 1", 1-1/4" in wooden box	0734442198987	5	1	130.11	156.13	GM

Best in category steel quality for improved sharpness and edge retention
Blade hardened and tempered for long chisel life
ProTouch™ grip for added comfort
Durable handle to withstand tradesmen abuse
Large strike cap to withstand hammer impacts

MS500 ALL-PURPOSE CHISELS WITH STRIKING CAP



MS500 SINGLES

Item No.	Description	EAN	Master Pack	Shelf Pack	LP Ex VAT £ / Item	RRP Inc VAT £ / Item	DISC. CODE
10501698	MS500 1/4" / 6mm, with Striking Cap	5706915016987	48	4	10.33	12.40	GM
10501700	MS500 3/8" / 10mm, with Striking Cap	5706915017007	48	4	10.56	12.67	
10501702	MS500 1/2" / 13mm, with Striking Cap	5706915017021	48	4	10.58	12.70	
10501705	MS500 5/8" / 16mm, with Striking Cap	5706915017052	48	4	10.73	12.88	
10501706	MS500 3/4" / 19mm, with Striking Cap	5706915017069	48	4	10.82	12.98	
10501708	MS500 1" / 25mm, with Striking Cap	5706915017083	48	4	11.98	14.38	
10503669	MS500 1-1/4" / 32mm, with Striking Cap	5706915036695	48	4	15.21	18.25	
10503670	MS500 1-1/2" / 38mm, with Striking Cap	5706915036701	24	2	17.01	20.41	
10503425	MS500 2" / 51mm, with Striking Cap	5706915034257	24	2	17.38	20.86	

MS500 SETS



10503426



10507931



10503430

Item No.	Description	EAN	Master Pack	Shelf Pack	LP Ex VAT £ / Item	RRP Inc VAT £ / Item	DISC. CODE
10503426	MS500 3 pcs Set - 1/2", 3/4" & 1" in wallet	5706915034264	16	4	33.19	39.83	GM
10507615	MS500 3 pcs Set - 1/2", 3/4" & 1" in plastic case	5706915076158	16	4	33.19	39.83	
10505173	MS500 4 pcs Set - 1/4", 1/2", 3/4" & 1" in clamshell	5706915051735	16	4	43.72	52.46	
10503428	MS500 5 pcs Set - 1/4", 3/8", 1/2", 3/4", 1" in wallet	5706915076158	16	4	54.25	65.10	
10507931	MS500 6 pcs Set - 1/2", 3/4", 1", Sharpening Stone, Guide, Oil in plastic case	5706915079319	-	4	50.24	60.29	
10503430	MS500 6 pcs Set - 1/4", 3/8", 1/2", 3/4", 1", 1-1/4" in wooden box	5706915034301	5	1	69.46	83.35	

M444 BLUE-CHIP BEVEL EDGE CHISELS



Best in category steel quality for improved sharpness and edge retention
Blade hardened and tempered for long chisel life
Contoured handle provides added control
Strong handle for use with hand or mallet

M444 SINGLES

Item No.	Description	EAN	Master Pack	Shelf Pack	LP Ex VAT £ / Item	RRP Inc VAT £ / Item	DISC. CODE
TM44418	M444 1/8" / 3mm	0734442196440	24	6	8.34	10.01	GM
TM44414	M444 1/4" / 6mm	0734442196563	24	6	7.02	8.42	
TM44438	M444 3/8" / 10mm	0734442196686	24	6	7.21	8.65	
TM44412	M444 1/2" / 13mm	0734442196808	24	6	7.42	8.90	
TM44458	M444 5/8" / 16mm	0734442196921	24	6	7.80	9.36	
TM44434	M444 3/4" / 19mm	0734442197041	24	6	8.27	9.92	
TM4441	M444 1" / 25mm	0734442197164	24	6	9.08	10.90	
TM444114	M444 1-1/4" / 32mm	0734442197287	24	6	10.87	13.04	
TM444112	M444 1-1/2" / 38mm	0734442197409	24	6	11.72	14.06	
TM4442	M444 2" / 51mm	0734442201960	24	6	15.31	18.37	

M444 SETS



TM444S3



TM444S4



TM444S5



TM444S6

Item No.	Description	EAN	Master Pack	Shelf Pack	LP Ex VAT £ / Item	RRP Inc VAT £ / Item	DISC. CODE
TM444S3	M444 3 pcs Set - 1/2", 3/4" & 1" in clamshell	0734442197508	16	4	24.77	29.72	GM
TM444S4	M444 4 pcs Set - 1/4", 1/2" - 3/4" & 1" in clamshell	0734442197522	16	4	31.80	38.16	
TM444S5	M444 5 pcs Set - 1/4", 3/8", 1/2", 3/4" & 1" in clamshell	0734442197645	16	4	39.01	46.81	
TM444S6	M444 6 pcs Set - 1/4", 3/8", 1/2", 3/4", 1" & 1-1/4" in wooden box	0734442197652	5	1	46.81	56.17	

CHISEL SHARPENING SET

Item No.	Description	EAN	Master Pack	Shelf Pack	LP Ex VAT £ / Item	RRP Inc VAT £ / Item	DISC. CODE
10507932	3 pcs Sharpening Set includes Stone, Guide and Oil	5706915079326	16	4	17.06	20.47	GM



BEVELS AND SQUARES

Bevelled squares are used for marking out lines, testing squares and angle lengths. Sliding bevels are used for marking angle lengths. All measuring tools are made from aluminium block and with a steel blade. The scales are etched on the surface which ensures long durability and are manufactured according to very fine tolerances, so all IRWIN® measuring tools are very precise.



TRI & MITRE SQUARES - METRIC

Item No.	Description	EAN	Master Pack	Shelf Pack	LP Ex VAT £ / Item	RRP Inc VAT £ / Item	DISC. CODE
10503543	Tri & Mitre Square 250mm	5706915035438	-	4	15.24	18.29	IR (HT)
10503544	Tri & Mitre Square 300mm	5706915035445	-	4	16.52	19.82	
10503545	Tri & Mitre Square 350mm	5706915035452	-	4	18.42	22.10	



TRI & MITRE SQUARES - IMPERIAL

Item No.	Description	EAN	Master Pack	Shelf Pack	LP Ex VAT £ / Item	RRP Inc VAT £ / Item	DISC. CODE
TM22006	Tri Square with Brass Plate 6"	0734442231004	36	6	30.30	36.36	GM
TM22009	Tri Square with Brass Plate 9"	0734442231127	36	6	35.49	42.59	
TMR22086	Tri Square 6"	0734442231363	48	6	18.84	22.61	
TMR22089	Tri Square 9"	0734442231486	48	6	21.15	25.38	
TM22012	Tri Square 12"	0734442231240	36	6	43.31	51.97	
TMR2210	Mitre Square 10"	0734442231608	36	1	20.36	24.43	



SLIDING BEVELS - METRIC

Item No.	Description	EAN	Master Pack	Shelf Pack	LP Ex VAT £ / Item	RRP Inc VAT £ / Item	DISC. CODE
10503546	Sliding Bevel 250mm	5706915035469	-	4	19.22	23.06	IR (HT)
10503547	Sliding Bevel 300mm	5706915035476	-	4	19.22	23.06	



SLIDING BEVELS - IMPERIAL

Item No.	Description	EAN	Master Pack	Shelf Pack	LP Ex VAT £ / Item	RRP Inc VAT £ / Item	DISC. CODE
TM2226	Sliding Bevel 9"	0734442231844	48	4	26.85	32.22	GM
TM22261012	Sliding Bevel 10-1/2"	0734442071167	48	4	27.68	33.22	

GENERAL WOODWORKING TOOLS

These tools are an essential part of any workshop or toolbox. They all contribute to the final fit of the timber to ensure the highest quality finish.

BRADAWLS



Item No.	Description	EAN	Master Pack	Shelf Pack	LP Ex VAT £ / Item	RRP Inc VAT £ / Item	DISC. CODE
TM1838W	Bradawl Wooden Handled	0734442234722	72	12	6.13	7.36	GM

MORTICE, MARKING AND CUTTING GAUGES

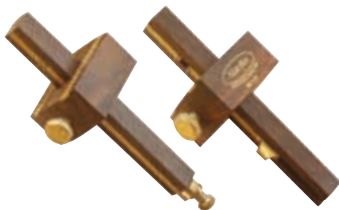

Item No.	Description	EAN	Master Pack	Shelf Pack	LP Ex VAT £ / Item	RRP Inc VAT £ / Item	DISC. CODE
TM2153	Mortice & Marking Gauge	0734442232322	24	4	37.00	44.40	GM
TM2154	Mortice & Marking Gauge with thumbscrew slide	0734442232445	12	1	58.66	70.39	
TMR2049	Marking Gauge	0734442231967	48	4	11.89	14.27	
TM2083	Cutting Gauge	0734442232209	24	4	22.13	26.56	

PLANES & PLANE CUTTERS

BENCH PLANES

IRWIN® Record® bring decades of experience, well proven design and advanced production techniques to produce this fine range of woodworking planes.



Item No.	Description	EAN	Master Pack	Shelf Pack	LP Ex VAT £ / Item	RRP Inc VAT £ / Item	DISC. CODE
T04	Smoothing Plane, 9-3/4" - 2" (50mm), Wooden Handle	0734442053408	24	1	72.72	87.26	RR
TSP4	Smoothing Plane, 9-3/4" - 2" (50mm), Plastic Handle	0734442165729	48	4	41.24	49.49	
T05	Jack Plane, 14" - 2" (50mm), Wooden Handle	0734442536482	24	1	86.95	104.34	
TSP5	Jack Plane, 14" - 2" (50mm), Plastic Handle	0734442165910	48	4	53.61	64.33	
T07	Jointer Plane, 22" (60mm) - 2-3/8" - length 550mm, Wooden Handle	0734442054009	12	1	167.66	201.19	

REBATE PLANE

Item No.	Description	EAN	Master Pack	Shelf Pack	LP Ex VAT £ / Item	RRP Inc VAT £ / Item	DISC. CODE
T778	Rebate Plane, Length 8-1/2" - Cuts Rebates up to 1-1/2" 38mm	0734442559252	12	1	134.06	160.87	RR

BLOCK PLANES

Item No.	Description	EAN	Master Pack	Shelf Pack	LP Ex VAT £ / Item	RRP Inc VAT £ / Item	DISC. CODE
T06012	Block Plane, 6" (42mm) - 1-5/8" 12-1/2" - 20° low angle	0734442552086	24	4	71.08	85.30	RR
T0912	Block Plane, 6" (42mm) - 1-5/8" 12-1/2"	0734442548430	24	4	71.08	85.30	

SPOKESHAVES

The IRWIN® Record® Spokeshave is used for chamfering and shaping - flat-faced (A151) for convex surfaces and round-faced (A151R) for concave surfaces.

Item No.	Description	EAN	Master Pack	Shelf Pack	LP Ex VAT £ / Item	RRP Inc VAT £ / Item	DISC. CODE
TA151	Spokeshave, Flatface Length 10" (54mm)	0734442056164	24	4	26.84	32.21	RR
TA151R	Spokeshave, Roundface Length 10" (54mm)	0734442056287	24	4	26.84	32.21	

REPLACEMENT PLANE CUTTERS

Item No.	Description	EAN	Master Pack	Shelf Pack	LP Ex VAT £ / Item	RRP Inc VAT £ / Item	DISC. CODE
TSI2	Plane Cutter 50 mm for 04, 05, SP4 & SP5	0734442056522	24	6	13.69	16.43	RR
TSI238	Plane Cutter 2-3/8" for 06, 07	0734442056645	24	6	16.96	20.35	
T0220D	Plane Cutter 6" (42 mm) for 09-1/2" & 060-1/2"	0734442057963	24	1	13.08	15.70	
T778D	Plane Cutter for 778	0734442058809	24	1	14.40	17.28	
TA151B	Plane Cutter 42mm	0734442058922	24	1	8.10	9.72	

High-quality cast grey iron body with precision machined base
Carbon steel cutting iron
Robust lever cap has three pressure points & brass locking nut for secure location of the cutting iron
Fine adjustment is controlled by a brass adjusting nut and lateral adjusting lever



BEVELS, SQUARES & PLANES



QUICK-GRIP®

In 1986 Joe Sorensen, an air boat builder in Nebraska USA, was looking for a better way to hold down his steel panels as the clamps he was using twisted the thin steel as he worked.

A year later, with a good idea for a new style of clamping, he came to American Tools and soon became an employee and working together, the concept for a pistol grip one-handed bar clamp was born. This revolutionary tool was quickly patented and brought to market in 1989 with a full line of clamps under the Quick-Grip® brand name. The line was later extended from the Original clamp to the Micro, Mini, Handi, Quick-Change, and more recently the XP clamp.

Since the launch, IRWIN® Quick-Grip® has become the world leader in one-handed bar clamps and is the industry standard which has changed the way tradesman do their jobs, greatly improving their ability and efficiency on the job.



Record®

Originally established in 1898 in the South Yorkshire city of Sheffield in the UK. The Record Tools Factory was swiftly able to make a long lasting contribution to the worldwide reputation of the region for the manufacture of high quality steel and castings.

The Record® brand name was introduced in 1909 and by the 1920's the product range had expanded into Vices, Planes, Clamps and Pipe Wrenches enabling the business to grow rapidly in the UK and many overseas markets.

Today, IRWIN® Record® continues excelling by sticking to the traditional values set by its founders, producing tools that are highly valued amongst professional users for quality and durability that remains strong today.



QUICK CLAMPS



VICES

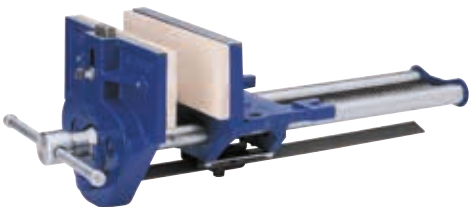

STEEL CLAMPS



XP

XP ONE-HANDED BAR CLAMP/SPREADER

MAXIMUM GRIPPING STRENGTH WITH ONE HAND

The clamp offers "Xtreme Pressure" which is up to two times greater than all of its competitors. Full face pads and a supporting foot have been added, plus lockable swivel jaws to ensure that both jaws are always parallel and pressure is evenly distributed when gluing.



- 1. FULL FACE PADS**
(Replaceable)
- 2. LOCKABLE SWIVEL JAWS**
- 3. UP TO TWO TIMES MORE CLAMPING FORCE**
Than other one-handed bar clamps
- 4. QUICK-CHANGE SCREW**
No tool required, easily converts clamp to a spreader
- 5. SUPPORTING FOOT**
(18", 24", 36" & 50")
- 6. LOW-EXPLOSIVE RELEASE MECHANISM**
- 7. FREE SLIDING I-BEAM BAR**

182576
XP Replacement Pads



Item No.	Description	Clamp Capacity	EAN	Master Pack	Shelf Pack	LP Ex VAT £ / Item	RRP Inc VAT £ / Item	DISC. CODE
10505942	XP One-Handed Bar Clamp/Spreader, 6" / 150mm	6" / 150mm	5706915059427	-	5	24.35	29.22	IR (HT)
10505943	XP One-Handed Bar Clamp/Spreader, 12" / 300mm	12" / 300mm	5706915059434	-	5	27.18	32.62	
10505944	XP One-Handed Bar Clamp/Spreader, 18" / 450mm	18" / 450mm	5706915059441	-	5	30.09	36.11	
10505945	XP One-Handed Bar Clamp/Spreader, 24" / 600mm	24" / 600mm	5706915059458	-	5	34.38	41.26	
10505946	XP One-Handed Bar Clamp/Spreader, 36" / 900mm	36" / 900mm	5706915059465	-	4	42.99	51.59	
10505947	XP One-Handed Bar Clamp/Spreader, 50" / 1250mm	50" / 1250mm	5706915059472	-	4	53.00	63.60	
1826576	XP Replacement Pads, 2 per Pack	-	0038548998640	-	5	4.86	5.83	

QUICK-CHANGE BAR CLAMP/SPREADER

The original Quick-Change product has now been improved to provide the consumer with a greater clamping hold load (135kg), plus a new-to-the-market lockable swivel feature which enables uneven surfaces to be clamped.

**Quick
CHANGE**TM

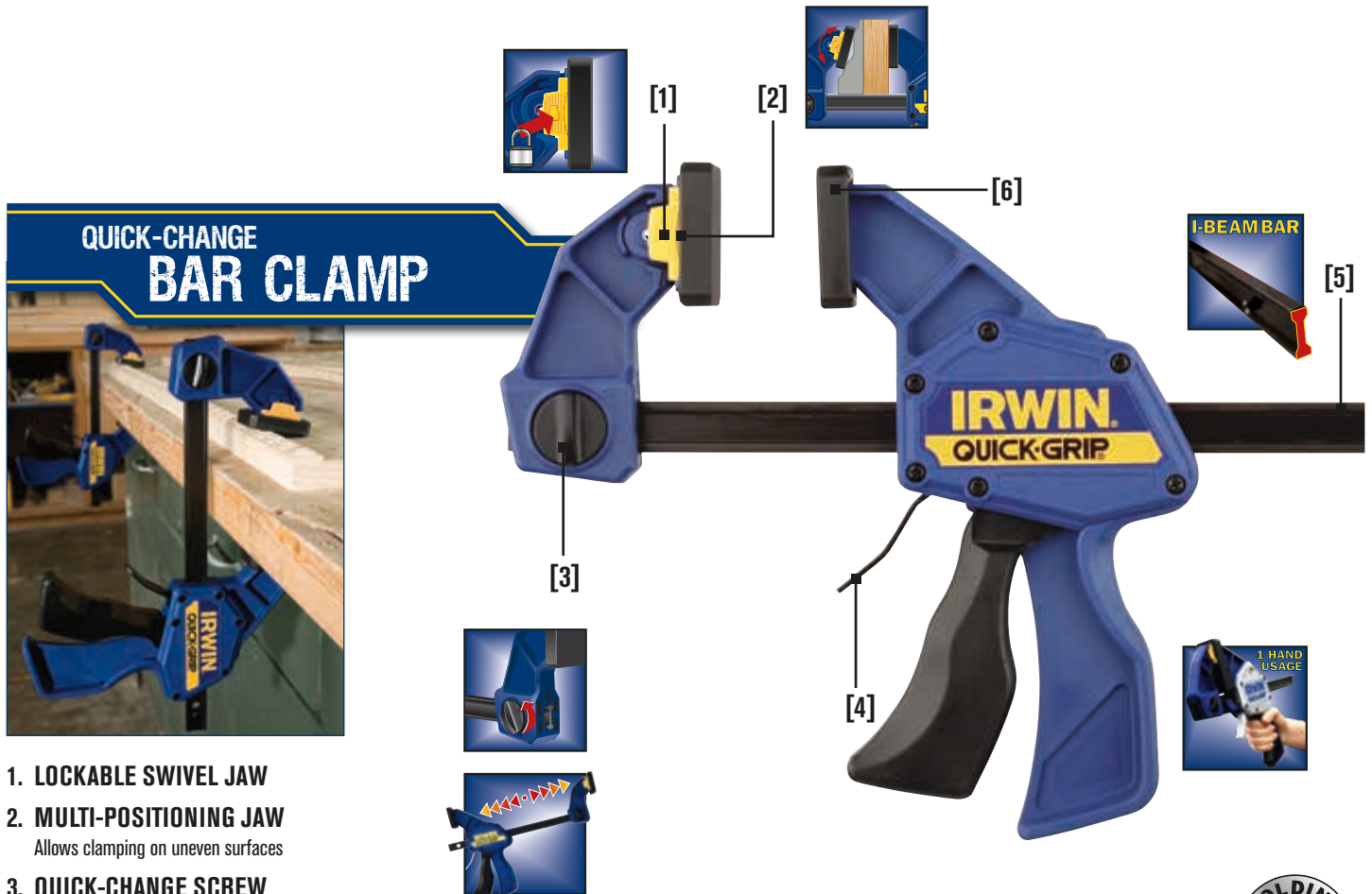

1. **LOCKABLE SWIVEL JAW**
2. **MULTI-POSITIONING JAW**
Allows clamping on uneven surfaces
3. **QUICK-CHANGE SCREW**
No tool required, easily converts clamp to a spreader
4. **QUICK-RELEASE TRIGGER**
5. **FREE SLIDING I-BEAM BAR**
6. **FULL FACE PADS**
(Replaceable)



Item No.	Description	Clamp Capacity	EAN	Master Pack	Shelf Pack	LP Ex VAT £ / Item	RRP Inc VAT £ / Item	DISC. CODE
T506QCEL7	Quick-Change Bar Clamp, 6"/150mm	6" / 150mm	5706915000061	-	5	20.27	24.32	IR (HT)
T512QCEL7	Quick-Change Bar Clamp, 12"/300mm	12" / 300mm	5706915000078	-	5	22.67	27.20	
T518QCEL7	Quick-Change Bar Clamp, 18"/455mm	18" / 455mm	5706915000085	-	5	25.07	30.08	
T524QCEL7	Quick-Change Bar Clamp, 24"/605mm	24" / 600mm	5706915000092	-	5	28.64	34.37	
T536QCEL7	Quick-Change Bar Clamp, 36"/910mm	36" / 900mm	5706915000108	-	5	35.80	42.96	
1826577	Quick-Change Replacement Pads, 4 per Pack	-	0038548998657	-	5	4.86	5.83	

182577
Quick-Change Replacement Pads



mini

Quick-release trigger for fast and easy positioning
Pistol Grip Design enhance comfort and ease of use
Removable soft pads



182578
Mini Replacement Pads



182579
Handi Clamp Replacement Pads



MINI BAR CLAMPS

The IRWIN® Quick-Grip® Mini Bar Clamps are ideal for woodworking and all sorts of smaller projects.



Item No.	Description	Clamp Capacity	EAN	Master Pack	Shelf Pack	LP Ex VAT £ / Item	RRP Inc VAT £ / Item	DISC. CODE
T546EL7	Mini Bar Clamp, 6" / 150mm	6" / 150mm	5715110790585	-	5	7.26	8.71	IR (HT)
T5412EL7	Mini Bar Clamp, 12" / 300mm	12" / 300mm	5715110790622	-	5	8.85	10.62	IR (HT)
1826578	Mini Replacement Pads, 4 per Pack	-	0038548998664	-	5	3.12	3.74	

MICRO BAR CLAMP

Specially designed for home, craft and hobby use. Ideal for delicate work requiring light clamping pressure.

Item No.	Description	Clamp Capacity	EAN	Master Pack	Shelf Pack	LP Ex VAT £ / Item	RRP Inc VAT £ / Item	DISC. CODE
T53006EL7	Micro Bar Clamp, 4" / 100mm, twin pack	4" / 100mm	5715110790547	-	10	4.11	4.93	IR (HT)

HANDI CLAMPS

Strong ratcheting mechanism provides variable clamping pressure. Quick-Release trigger allows for fast and easy positioning and release. The ideal clamp for jobs in workshop, house and garden. Specially designed jaws hold odd-shaped workpieces.

Item No.	Description	Clamp Capacity	EAN	Master Pack	Shelf Pack	LP Ex VAT £ / Item	RRP Inc VAT £ / Item	DISC. CODE
T59100ECD	Handi Clamp, 1-1/4" / 38mm	1-1/4" / 38mm	0038548591001	-	20	5.20	6.24	IR (HT)
T59200ECD	Handi Clamp, 2" / 50mm	2" / 50mm	0038548592008	-	12	8.35	10.02	
T59400ECD	Handi Clamp, 4" / 100mm	4" / 100mm	0038548594002	-	10	11.59	13.91	
1826579	Handi Clamp Replacement Pads, 6 per Pack	-	0038548998671	-	5	3.12	3.74	

SPRING CLAMPS

Item No.	Description	Clamp Capacity	EAN	Master Pack	Shelf Pack	LP Ex VAT £ / Item	RRP Inc VAT £ / Item	DISC. CODE
T58100EL7	Spring Clamp, 1" / 25mm	1" / 25mm	0038548581019	50	10	3.33	4.00	IR (HT)
T58200EL7	Spring Clamp, 2" / 50mm	2" / 50mm	0038548582016	50	10	5.08	6.10	
T58300EL7	Spring Clamp, 3" / 75mm	3" / 75mm	0038548583013	25	5	7.63	9.16	

CLAMPING TOOLS APPLICATION GUIDE

ONE-HANDED BAR CLAMPS

HANDI / SPRING CLAMPS



Clamps & Specs

	Micro Bar Clamp	Mini Bar Clamp	Quick-Change	XP	Handi-Clamp	Spring Clamp
Holding Force:	18 kg	70 kg	135 kg	250 kg	20 - 40 kg	15 - 30 kg
Clamp Capacity:	100 mm	150 - 300 mm	150 - 900 mm	150 - 1200 mm	30 - 100 mm	30 - 75 mm
Throat Depth:	30 mm	73 mm	90 mm	95 mm	38 - 100 mm	30 - 75 mm
Crafts/light-duty clamping	●	●	◐		◐	○
Temporary hold-down quick clamping	●	●	●	◐	◐	○
Flat panels/Solid edge wood glue-up/Deep-reach clamping				◐		
Irregular shape/Multiple surface/Corner joining			◐	◐		
Installation/Demolition/Heavy-duty clamping			○	●		

- = Good
- ◐ = Better
- = Best

HEAVY-DUTY CLAMPING

IRWIN® RECORD® PRO CLAMP

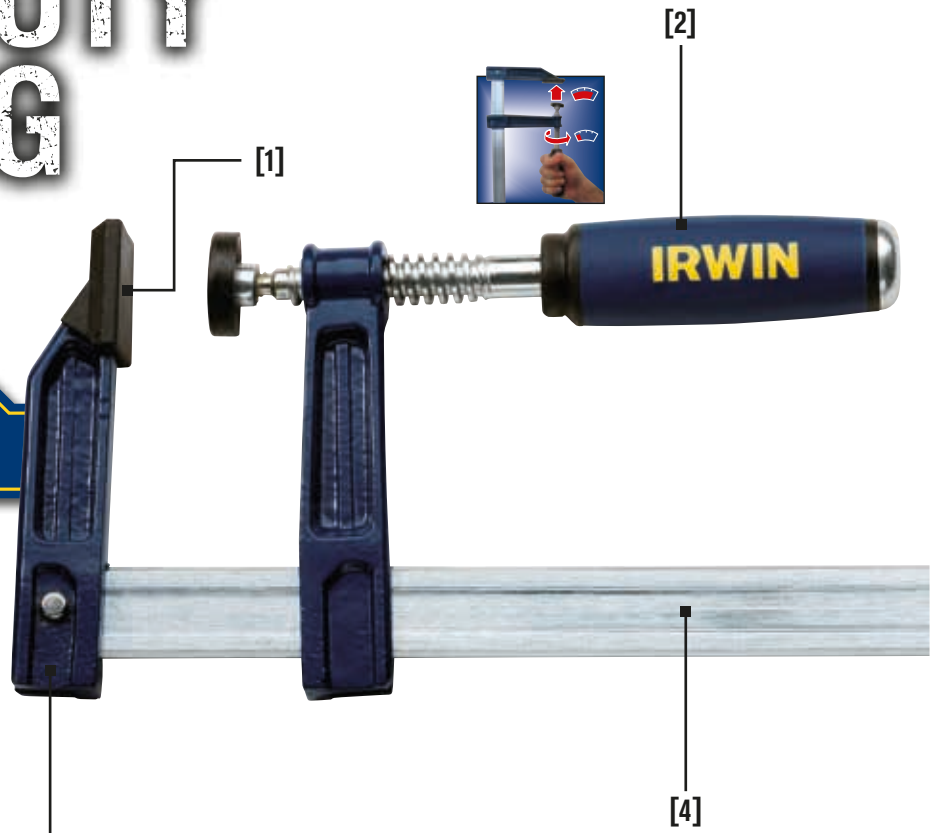

- 1. TPE PADS**
Provide friction to work surface
Reduce marking of work piece.
- 2. 3-COMPONENT HANDLE**
For higher torque transfer than wood,
plus added comfort.
- 3. IMPROVED DESIGN**
New improved Rib location to improve
strength at less weight.
- 4. I-BEAM DESIGN**
Provides higher mechanical strength and
less torsion. Zinc plated for rust
prevention.

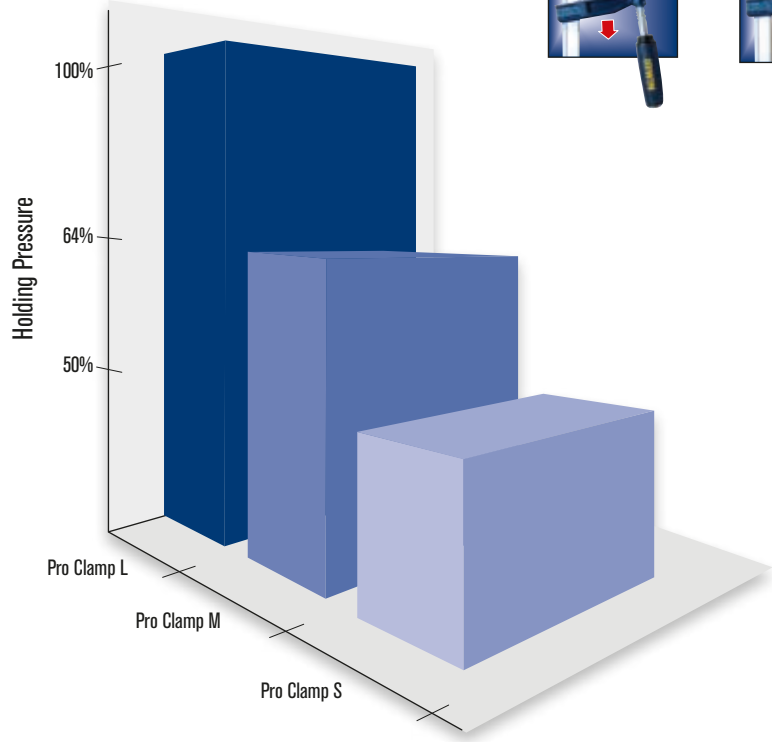

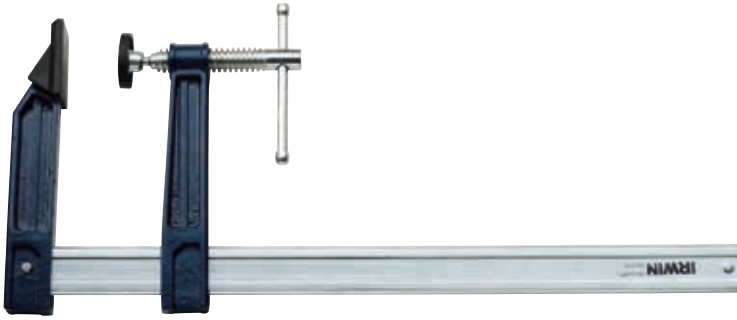

PRO CLAMP L WITH TOMMY BAR - CLAMPING DEPTH 140mm

Bar Dimension 35 x 9 mm

Item No.	Description	Clamping Capacity	EAN	Master Pack	Shelf Pack	LP Ex VAT £ / Item	RRP Inc VAT £ / Item	DISC CODE
10503574	Pro Clamp L, 400mm	400mm / 16"	5706915035742	-	3	35.23	42.28	RR
10503575	Pro Clamp L, 600mm	600mm / 24"	5706915035759	-	3	39.17	47.00	
10503576	Pro Clamp L, 800mm	800mm / 32"	5706915035766	-	3	43.11	51.73	
10503577	Pro Clamp L, 1000mm	1000mm / 40"	5706915035773	-	3	46.83	56.20	
10503578	Pro Clamp L, 1250mm	1250mm / 50"	5706915035780	-	3	50.88	61.06	
10503579	Pro Clamp L, 1500mm	1500mm / 60"	5706915035797	-	3	54.90	65.88	



PRO CLAMP M - CLAMPING DEPTH 120mm

Bar Dimension 30 x 8 mm

Item No.	Description	Clamping Capacity	EAN	Master Pack	Shelf Pack	LP Ex VAT £ / Item	RRP Inc VAT £ / Item	DISC CODE
10503569	Pro Clamp M, 300mm	300mm / 12"	5706915035698	-	4	23.84	28.61	RR
10503570	Pro Clamp M, 400mm	400mm / 16"	5706915035704	-	4	24.99	29.99	
10503571	Pro Clamp M, 600mm	600mm / 24"	5706915035711	-	4	27.91	33.49	
10503572	Pro Clamp M, 800mm	800mm / 32"	5706915035728	-	4	31.01	37.21	
10503573	Pro Clamp M, 1000mm	1000mm / 40"	5706915035735	-	4	34.54	41.45	



PRO CLAMP S - CLAMPING DEPTH 80mm

Bar Dimension 25 x 6 mm

Item No.	Description	Clamping Capacity	EAN	Master Pack	Shelf Pack	LP Ex VAT £ / Item	RRP Inc VAT £ / Item	DISC CODE
10503564	Pro Clamp S, 200mm	200mm / 8"	5706915035643	-	4	13.68	16.42	RR
10503565	Pro Clamp S, 300mm	300mm / 12"	5706915035650	-	4	16.51	19.81	
10503566	Pro Clamp S, 400mm	400mm / 16"	5706915035667	-	4	17.88	21.46	
10503567	Pro Clamp S, 600mm	600mm / 24"	5706915035674	-	4	19.25	23.10	
10503568	Pro Clamp S, 800mm	800mm / 32"	5706915035681	-	4	20.61	24.73	





T-BAR CLAMPS 136 SERIES AND SPARE PART

These clamps resist twisting and distortion under clamping pressures. Both the head and slide are guaranteed unbreakable. The slide is secured by a solid steel pin passing through one of the locating holes spaced along the steel bar. The steel mainscrew applies pressure quickly and smoothly through a fast acting, hard wearing rolled thread. Slides and heads are flat bottomed so that the clamp will stand without support.

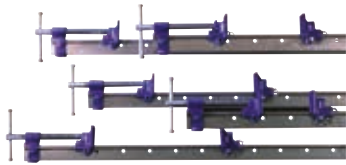

Item No.	Description	Clamping Capacity	EAN	Master Pack	Shelf Pack	LP Ex VAT £ / Item	RRP Inc VAT £ / Item	DISC. CODE
T1365	T-Bar Clamp, 1070mm	1070mm / 42"	0734442034087	-	1	60.27	72.32	RI
T1366	T-Bar Clamp, 1200mm	1200mm / 48"	0734442034209	-	1	62.69	75.23	
T1367	T-Bar Clamp, 1350mm	1350mm / 54"	0734442034322	-	1	63.58	76.30	
T1369	T-Bar Clamp, 1680mm	1680mm / 66"	0734442034445	-	1	69.37	83.24	
T13611	T-Bar Clamp, 1980mm	1980mm / 78"	0734442034568	-	1	82.19	98.63	
TL1366	48" Lengthening Bar (1220mm)		0734442034681	-	1	50.26	60.31	
T136D	Tailslide with Peg & Chain		0734442046561	-	1	45.64	54.77	

SASH CLAMPS 135 SERIES AND SPARE PARTS

These are heavy duty clamps with a bar section of 32mm x 6mm (1-1/4" x 1/4"). The slide and head are guaranteed unbreakable.



Item No.	Description	Clamping Capacity	EAN	Master Pack	Shelf Pack	LP Ex VAT £ / Item	RRP Inc VAT £ / Item	DISC. CODE
T1352	Sash Clamp, 24" / 610mm	24" / 610mm	0734442033363	-	1	42.50	51.00	RI
T1353	Sash Clamp, 30" / 760mm	30" / 760mm	0734442033486	-	1	44.17	53.00	
T1354	Sash Clamp, 36" / 915mm	36" / 915mm	0734442033608	-	1	46.56	55.87	
T1355	Sash Clamp, 42" / 1070mm	42" / 1070mm	0734442033721	-	1	49.55	59.46	
T1356	Sash Clamp, 48" / 1220mm	48" / 1220mm	0734442033844	-	1	50.58	60.70	
T1357	Sash Clamp, 54" / 1370mm	54" / 1370mm	0734442033851	-	1	51.75	62.10	
T1359	Sash Clamp, 66" / 1980mm	66" / 1980mm	0734442033875	-	1	52.93	63.52	
TL1354	Sash Clamp, 36" Lengthening Bar (915mm)		0734442033967	-	1	34.15	40.98	
T135D	Tailslide with Peg & Chain		0734442045366	-	1	28.14	33.77	
T135E	Peg & Chain		0734442045960	-	1	10.44	12.53	

CLAMP HEADS

Low cost alternative to full size bar clamps. The grey cast iron head and slide with steel mainscrew can be fitted to a wooden batten 1 1/2" / 38mm thick by 1-1/2" / 38mm wide and any length.

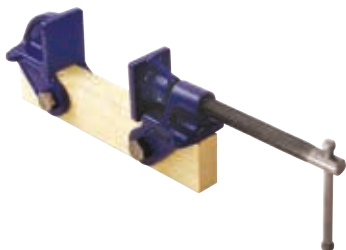

Item No.	Description	EAN	Master Pack	Shelf Pack	LP Ex VAT £ / Item	RRP Inc VAT £ / Item	DISC. CODE
TM130	Clamp Head, 25 x 38mm	0734442348078	-	6	21.76	26.11	RR

MITRE CUTTING CORNER CLAMPS

Accurate mitre clamping is provided by IRWIN® Record® Corner Clamps. The clamps have two countersunk holes for fixing to a wooden block, which can then be secured between the jaws of a bench vice. Thanks to the precision machined clamping surfaces and open design, these clamps are straight forward to operate and provide easy access for glueing and nailing.



Item No.	Description	Clamping Capacity	EAN	Master Pack	Shelf Pack	LP Ex VAT £ / Item	RRP Inc VAT £ / Item	DISC. CODE
TM140	Mitre Cutting Corner Clamp 50mm	50mm / 2"	0734442028444	24	1	16.48	19.78	RR
TM141	Mitre Cutting Corner Clamp 100mm	100mm / 4-1/4"	0734442028404	24	1	58.35	70.02	

FLOORING CLAMP

Designed to close up floor boards prior to nailing, this compact and robust clamp has two spring loaded cams which straddle the joist, holding the clamp firmly in position. Turning the handle then moves the shoe forward, pushing the floorboard into position. For standard 75mm / 3" joists.



Item No.	Description	Clamping Capacity	EAN	Master Pack	Shelf Pack	LP Ex VAT £ / Item	RRP Inc VAT £ / Item	DISC. CODE
TMFC153	Flooring Clamp 75mm	75mm / 3"	0734442034926	6	1	212.45	254.94	RR

HEAVY-DUTY G-CLAMPS 121 SERIES

IRWIN®'S STRONGEST G-CLAMP

IRWIN® Record® Heavy-Duty G-Clamps are the strongest you can buy. Recommended particularly for metalworking and fabrication work where a very high clamping force is demanded.

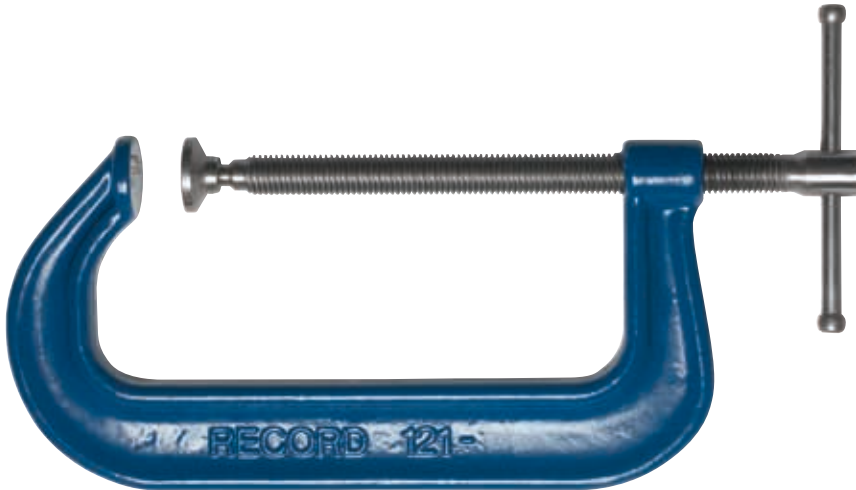

Drop-forged steel frame for strength and durability. Recommended for heavy-duty metal and fabrication work

Swivel shoe helps clamping on uneven surfaces
Twin-start Acme cold rolled thread for faster operation

Fused steel handle will bend before the clamp can be overstressed

Item No.	Description	Clamping Capacity	EAN	Master Pack	Shelf Pack	LP Ex VAT £ / Item	RRP Inc VAT £ / Item	DISC. CODE
T1213	Heavy-Duty G-Clamp 3" / 75mm	75mm / 3"	0734442031802	24	4	33.85	40.62	RR
T1214	Heavy-Duty G-Clamp 4" / 100mm	100mm / 4"	0734442031925	24	4	48.94	58.73	
T1216	Heavy-Duty G-Clamp 6" / 150mm	150mm / 6"	0734442032045	12	1	65.31	78.37	
T1218	Heavy-Duty G-Clamp 8" / 200mm	200mm / 8"	0734442032168	12	1	83.00	99.60	
T12110	Heavy-Duty G-Clamp 10" / 250mm	250mm / 10"	0734442032281	6	1	115.39	138.47	
T12112	Heavy-Duty G-Clamp 12" / 300mm	300mm / 12"	0734442032403	6	1	159.39	191.27	

HEAVY-DUTY 121 SERIES	
CAPACITY	PROOF LOAD
75mm / 3"	2700 kg
100mm / 4"	3200 kg
150mm / 6"	4000 kg
200mm / 8"	5770 kg
250mm / 10"	6200 kg
300mm / 12"	6800 kg

STEEL CLAMPING

MEDIUM-DUTY G-CLAMPS 119 SERIES

IRWIN® Record® medium duty clamps have a thin frame for getting into tight corners and confined spaces, yet are very strong and rigid.

Item No.	Description	Clamping Capacity	EAN	Master Pack	Shelf Pack	LP Ex VAT £ / Item	RRP Inc VAT £ / Item	DISC. CODE
T1192	Medium-Duty G-Clamp 2" / 50mm	50mm / 2"	0734442030485	-	6	5.38	6.46	RR
T1193	Medium-Duty G-Clamp 3" / 75mm	75mm / 3"	0734442030720	-	6	7.29	8.75	
T1194	Medium-Duty G-Clamp 4" / 100mm	100mm / 4"	0734442000600	-	6	10.18	12.22	
T1196	Medium-Duty G-Clamp 6" / 150mm	150mm / 6"	0734442041337	-	6	11.48	13.78	
T1224	Deep Throat G-Clamp 4" / 100mm	100mm / 4"	0734442030843	40	4	45.56	54.67	



GENERAL PURPOSE G-CLAMPS 120 SERIES

Ideal for metal and woodworking applications, the IRWIN® Record® 120 is the most popular and widely used of G-Clamps.

Item No.	Description	Clamping Capacity	EAN	Master Pack	Shelf Pack	LP Ex VAT £ / Item	RRP Inc VAT £ / Item	DISC. CODE
T1203	General Purpose G-Clamp 3" / 75mm	75mm / 3"	0734442031086	72	4	17.92	21.50	RR
T1204	General Purpose G-Clamp 4" / 100mm	100mm / 4"	0734442031208	72	4	18.42	22.10	
T1206	General Purpose G-Clamp 6" / 150mm	150mm / 6"	0734442031321	60	4	26.36	31.63	
T1208	General Purpose G-Clamp 8" / 200mm	200mm / 8"	0734442031444	24	1	41.05	49.26	
T12010	General Purpose G-Clamp 10" / 250mm	250mm / 10"	0734442031567	24	1	63.46	76.15	
T12012	General Purpose G-Clamp 12" / 300mm	300mm / 12"	0734442031680	24	1	89.13	106.96	



IRWIN®

Record.

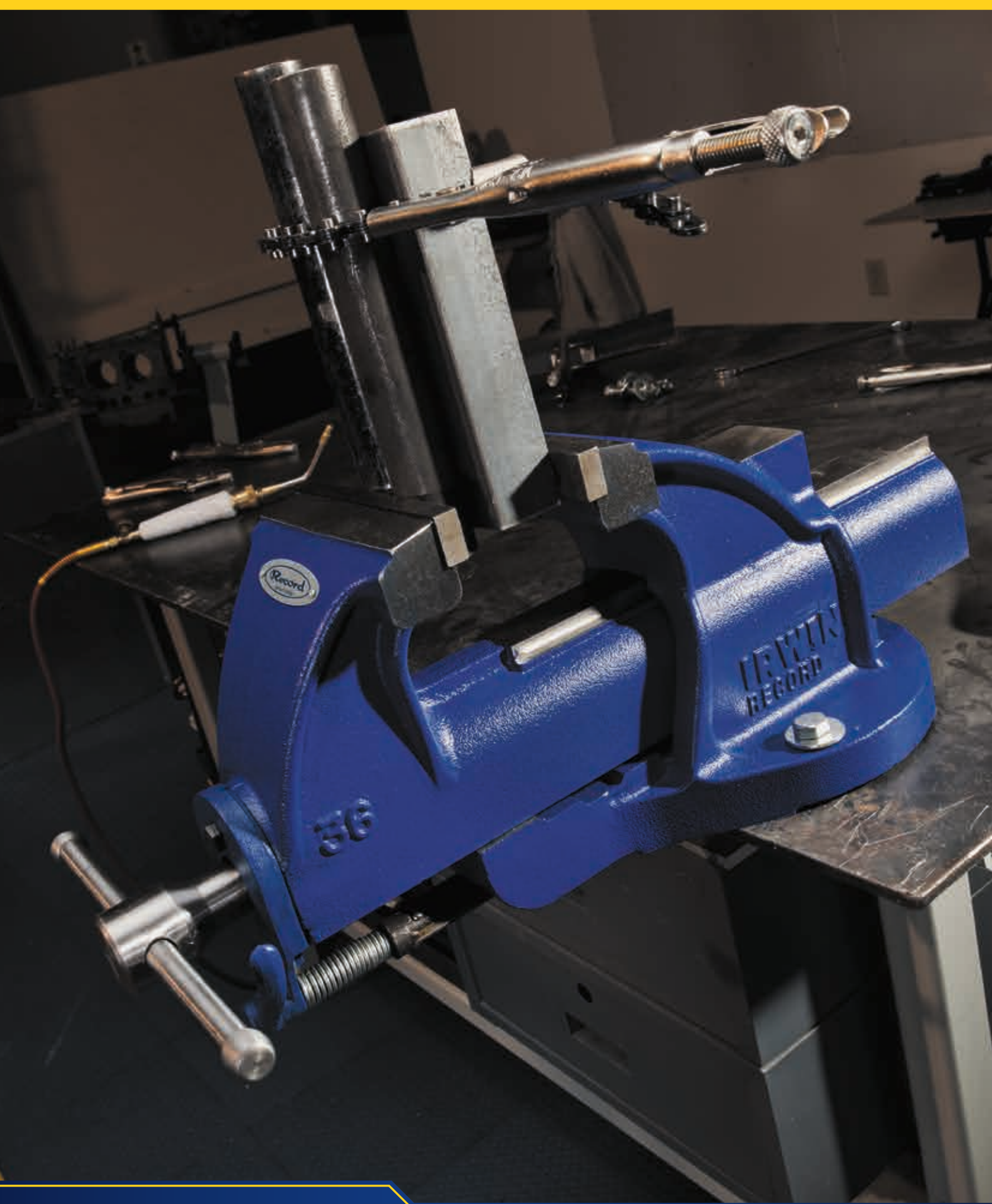

VICES AND ACCESSORIES

IRWIN® Record® Vices have become the benchmark by which all other vices are measured. Design, choice of materials and manufacturing disciplines each set very high standards which, for the end user, translate into safety, reliability and excellent value.

ENGINEERS' VICE - LIFETIME VICE RANGE

Designed for heavy-duty work, these vices are made from S.G. Ductile Iron with an integral anvil for shaping and beating, together with a quick-release mechanism for rapid slide adjustment. The reinforced body and slide, large diameter main screw allow these vices with the working strength and resilience to withstand the most demanding work. Fitters' vices are similar in design to Engineers' however made of close grained gray iron instead of S.G. Ductile Iron. Full line of replacement parts available.

ENGINEERS' AND FITTERS' VICES

1. IRWIN® ENGINEERS' VICES

Are made from S.G. Ductile Iron with high-impact resistance, guaranteeing strength and long life.

2. SAFETY STOP

Prevents the slide from being separated from the body.

3. FULLY MACHINED

On all load-bearing surfaces for smooth and troublefree operation.

4. FUSED STEEL HANDLE

Will bend before the vice can be overstressed.

5. QUICK-RELEASE MECHANISM

Disengages the main screw, allowing rapid movement of the slide.

6. UNBREAKABLE SG IRON NUT

Can be replaced when worn.

7. INTEGRAL ANVIL

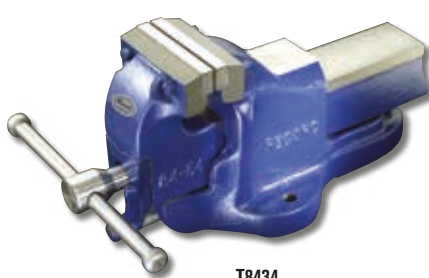
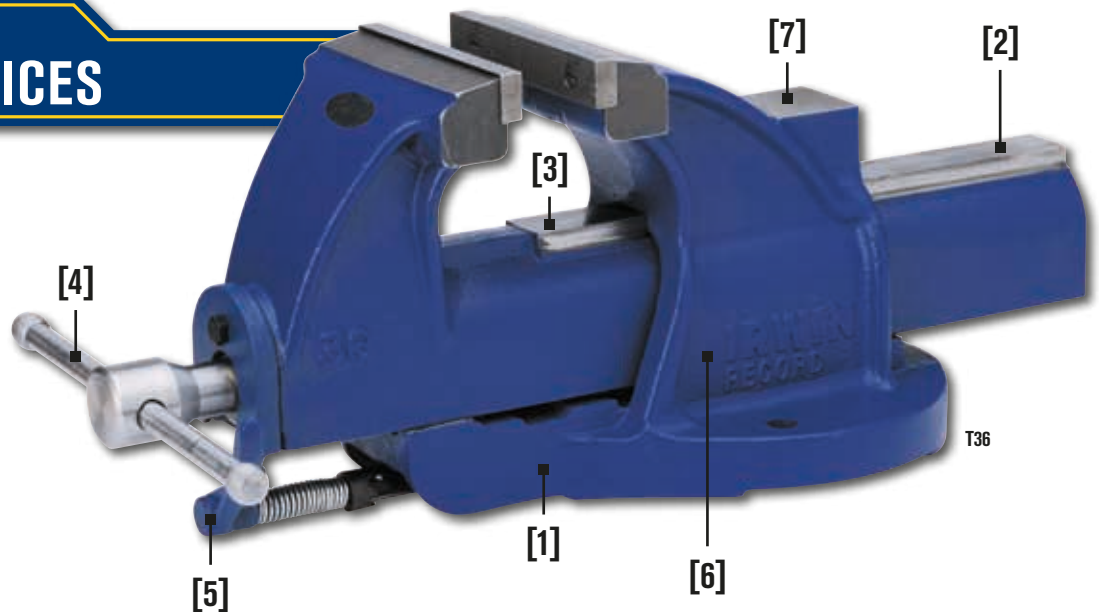

T8434

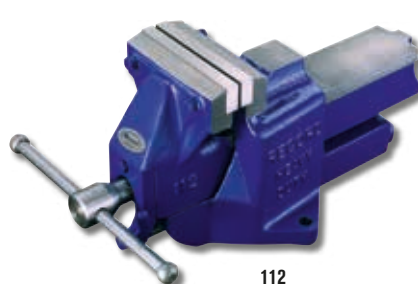

112



T25

SPARE PARTS ALSO AVAILABLE
SEE PAGE 59

Item No.	Description	EAN	Master Pack	Shelf Pack	LP Ex VAT £ / Item	RRP Inc VAT £ / Item	DISC. CODE
T8434	Engineers Vice 4-1/2" / 115mm**	0734442019442	42	1	574.98	689.98	RI
T36	Engineers Vice 6" / 150mm** (Irregular Shape)	0734442019206	18	1	990.17	1188.20	
112	Engineers Vice 6" / 150mm**	0734442019565	22	1	925.03	1110.04	
114ZR	Engineers Vice 8" / 205mm**	0734442019688	22	1	1275.98	1531.18	
23ZR	Fitters Vice 4-1/2" / 115mm	0734442001089	28	1	427.05	512.46	
T25	Fitters Vice 6" / 150mm	0734442001201	22	1	566.15	679.38	

**S.G. Ductile Iron is strong and flexible with similar characteristics to steel and is virtually unbreakable. Heavy duty vices manufactured from this material are designed to take much more punishing workloads than normal vices.

MECHANICS' VICE - HEAVY DUTY RANGE

Rigid and robust, the body and sliding jaw are cast from close grained grey iron which is machined on all friction surfaces for a smooth reliable action. The jaws, handle and main screw are steel, the latter having a two-start rolled acme thread to speed the jaws from fully closed to fully open with a minimum of winding. The most commonly used vice in the IRWIN® range. Full line of replacement parts available.

- Body and sliding jaw** are cast from close grained grey iron which is machined on all friction surfaces for a smooth reliable action
- Safety stop** prevents the slide from being separated from the body
- Replaceable hardened** steel jaws
- Unbreakable SG iron nut** can be replaced when worn
- Fused steel handle** will bend before the vice can be overstressed

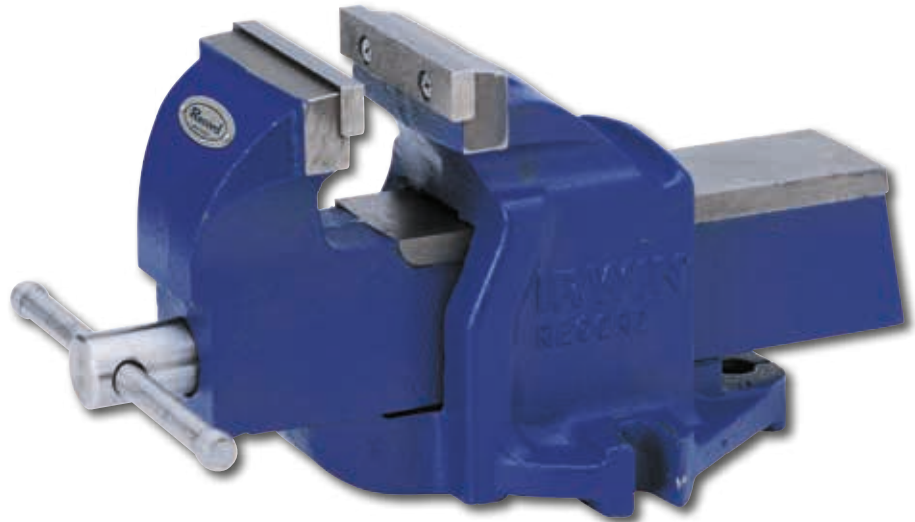

Item No.	Description	EAN	Master Pack	Shelf Pack	LP Ex VAT £ / Item	RRP Inc VAT £ / Item	DISC. CODE
1ZR	No 1, Mechanics' Vice 3" / 75mm	0734442000129	144	1	55.23	66.28	RR
3	No 3, Mechanics' Vice 4" / 100mm	0734442000488	60	1	107.42	128.90	RI
4ZR	No 4, Mechanics' Vice 4-1/2" / 115mm	0734442000501	40	1	188.47	226.16	
5	No 5, Mechanics' Vice 5" / 125mm	0734442000723	40	1	218.30	261.96	
6	No 6, Mechanics' Vice 6" / 150mm	0734442000846	32	1	324.77	389.72	
8ZR	No 8, Mechanics' Vice 8" / 205mm	0734442000969	24	1	579.71	695.65	

WORKSHOP VICES - MEDIUM DUTY

Strong and durable, the body and sliding jaw are cast from close-grained grey iron which is machined on all friction surfaces for a smooth reliable action. The jaws, handle and main screw are steel, the latter having a two-start rolled acme thread to speed the jaws from fully closed to fully open with a minimum of winding. This compact bench vice with anvil is specifically designed for medium-duty workshop applications for both the professional craftsman and the DIY enthusiast who expect a compact vice with superior clamping force, safety features and excellent finish.



Item No.	Description	EAN	Master Pack	Shelf Pack	LP Ex VAT £ / Item	RRP Inc VAT £ / Item	DISC. CODE
10507771	Workshop Vice with Anvil, 3-1/8" / 80mm	5706915077711	1	1	37.68	45.22	IR (HT)
T4121000	Workshop Vice with Anvil, 1 TON, 4" / 100mm	0734442000204	105	1	48.70	58.44	
T3TON3VS	Workshop Vice with Anvil, Swivel Base, 4" / 100mm	0734442000310	60	1	82.65	99.18	
4935505	Workshop Multi-Vice, with Anvil, Swivel Base, 5" / 125mm	0038548989990	40	1	140.55	168.66	
T6TON6VS	Workshop Vice with Anvil, Swivel Base, 6" / 150mm	0734442000860	40	1	175.69	210.83	

QUICK-RELEASE WOODWORKING VICE

Squeeze the trigger and a quick-release vice can be opened and closed without using the mainscrew. Large and small work pieces can be quickly interchanged, while releasing the trigger returns the mechanism to normal for fine adjustment. An ideal addition to the engineering workshop or tool room. For clamping and holding wood work pieces.

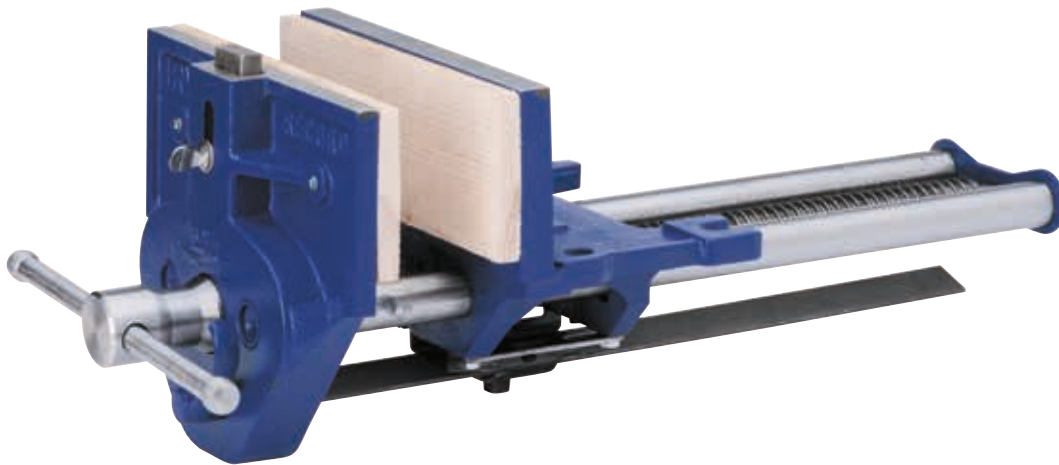

Two steel guide rods to reduce wear and ensure a smooth parallel action

Jaws "toe in" so that when pressure is applied they give an even clamping over the whole depth of the work piece

Adjustable dog used in conjunction with bench stops fitted into the bench top

Location holes are provided so you can fit your own choice of wooden cheeks to protect the work piece

Squeeze the trigger and a quick release vice can be opened and closed without using the mainscrew. Large and small work pieces can be quickly interchanged



PROFESSIONAL QUICK-RELEASE WOODWORKING VICES

Item No.	Description	EAN	Master Pack	Shelf Pack	LP Ex VAT £ / Item	RRP Inc VAT £ / Item	DISC. CODE
T52ED	Woodworking Vice - Quick-Release 7"/175mm	0734442030249	60	1	147.91	177.49	RR
T5212ED	Woodworking Vice - Quick-Release 9"/230mm	0734442030362	32	1	205.44	246.53	
T53ED	Woodworking Vice - Quick-Release 10-1/2"/265mm	0734442030010	24	1	219.14	262.97	

PLAIN SCREW VICES

Manufactured in three capacities, these full size workshop vices are designed for bench mounting. The cast grey iron body and front plate are precision machined to house two solid steel guide rods giving the vice a smooth, true parallel action free of side or cross movement.

Item No.	Description	EAN	Master Pack	Shelf Pack	LP Ex VAT £ / Item	RRP Inc VAT £ / Item	DISC. CODE
T52PD	Woodworking Vice - Plain Screw 7"/175mm	0734442047889	60	1	70.42	84.50	RR
T5212PD	Woodworking Vice - Plain Screw 9"/230mm	0734442047896	32	1	93.33	112.00	
T53PD	Woodworking Vice - Plain Screw 10-1/2"/265mm	0734442030133	24	1	103.65	124.38	

WOODCRAFT VICE

Lightweight vice for the young woodworker, or home handyman. Provides a robust product suitable for the professional who needs a compact vice for smaller work. Designed to be fitted under the work bench, in the normal way, so that the jaws are flush with the bench top. TV150B includes table clamp.

Item No.	Description	EAN	Master Pack	Shelf Pack	LP Ex VAT £ / Item	RRP Inc VAT £ / Item	DISC. CODE
TV149B	Woodcraft Vice 6"/150mm	0734442029656	-	1	28.45	34.14	RR
TV150B	Woodcraft Vice with Table Clamp 6"/150mm	0734442029779	-	1	30.12	36.14	
TV175B	Woodcraft Vice 7"/175mm	0734442029885	-	1	33.45	40.14	

TABLE VICE

This is an ideal portable vice for the amateur and model maker. The built-in clamp allows it to be easily and quickly attached to a bench, table or work surface. Pipe grips are incorporated below the parallel jaws. A useful anvil is also included on the rear of the body. An ideal portable vice for DIY and model making.

Item No.	Description	EAN	Master Pack	Shelf Pack	LP Ex VAT £ / Item	RRP Inc VAT £ / Item	DISC. CODE
TV75B	Table Vice 75mm	0734442001690	-	1	25.65	30.78	RR

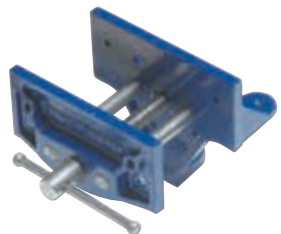

DRILL PRESS VICE

Quality and precision are the hallmarks of these IRWIN® Record® Drill Press Vices, an ideal addition to the engineering workshop or tool room. Designed for use with drill presses and pillar drills.



Item No.	Description	EAN	Master Pack	Shelf Pack	LP Ex VAT £ / Item	RRP Inc VAT £ / Item	DISC. CODE
T414	Drill Press Vice 4" / 100mm	0734442001560	-	1	143.18	171.82	RI

SWIVEL BASES

360 degree swivel bases are used to rotate and lock the vice at the most convenient angle.



Item No.	Description	EAN	Master Pack	Shelf Pack	LP Ex VAT £ / Item	RRP Inc VAT £ / Item	DISC. CODE
T15B	Swivel Base, (No. 1 Vice)	0734442002888	-	1	54.34	65.21	RI
T35B	Swivel Base, (No. 3 Vice)	0734442003007	-	1	85.46	102.55	
T45B	Swivel Base, (No. 4 & 5 Vice)	0734442003120	-	1	85.46	102.55	
T65B	Swivel Base, (No. 6, 8, 25 & 36 Vices)	0734442003366	-	1	120.08	144.10	
T8434235B	Swivel Base, (No. T8434 & 23ZR Vices)	0734442019459	-	1	100.57	120.68	
1050772	Swivel Base, (No. 1050772)	5706915077728	-	1	11.59	13.91	

FIBRE GRIPS

Designed for holding & protecting copper, aluminium, brass and similar soft metals.



Item No.	Description	EAN	Master Pack	Shelf Pack	LP Ex VAT £ / Item	RRP Inc VAT £ / Item	DISC. CODE
FG3	Fibre Grips 3" / 75mm	0734442001928	60	6	11.74	14.09	RI
FG4	Fibre Grips 4" / 100mm	0734442002161	60	6	16.64	19.97	
FG412	Fibre Grips 4-1/2" / 114mm	0734442002406	60	6	17.88	21.46	
FG5	Fibre Grips 5" / 125mm	0734442002529	60	6	19.36	23.23	
FG6	Fibre Grips 6" / 150mm	0734442002765	60	6	21.09	25.31	

CHAIN PIPE VICES

The chain pipe vice generates a powerful grip due to its sturdy construction. The drop-forged, heat-treated steel jaws and high-tensile steel chain are mounted on a body cast from ductile iron that is guaranteed unbreakable. The flexible chain means the vice is compact and easy to store when not in use.



SPARE PARTS ALSO AVAILABLE SEE PAGE 58

Item No.	Description	EAN	Master Pack	Shelf Pack	LP Ex VAT £ / Item	RRP Inc VAT £ / Item	DISC. CODE
T181C	Chain Pipe Vice 1/8" - 2" (3 - 50mm)	0734442143161	-	1	108.89	130.67	RI
T182C	Chain Pipe Vice 1/4" - 4" (6 - 100mm)	0734442143284	-	1	241.38	289.66	
T183C	Chain Pipe Vice 1/2" - 8" (12 - 200mm)	0734442143406	-	1	408.43	490.12	

HINGED PIPE VICES



Item No.	Description	EAN	Master Pack	Shelf Pack	LP Ex VAT £ / Item	RRP Inc VAT £ / Item	DISC. CODE
T92C	Hinged Pipe Vice 1/8" - 2" (3 - 50mm)	0734442143529	-	1	163.62	196.34	RI
T9212C	Hinged Pipe Vice 1/8" - 2-1/2" (3 - 60mm)	0734442143642	-	1	213.78	256.54	
T9312C	Hinged Pipe Vice 1/8" - 3-1/2" (3 - 90mm)	0734442143765	-	1	317.65	381.18	
T96	Hinged Pipe Vice 1/8" - 6" (3 - 150mm)	0734442143888	-	1	763.04	915.65	

TRIPOD STAND

The durable fabricated steel frame, topped by a strong heavy-gauge mounting plate, is drilled to accept our range of chain and hinged pipe vices.



Item No.	Description	EAN	Master Pack	Shelf Pack	LP Ex VAT £ / Item	RRP Inc VAT £ / Item	DISC. CODE
TTS10	Tripod Stand for Hinged Pipe Vice & Chain Pipe Vice (T182C, T92C, T9212C)	0734442142560	-	1	251.40	301.68	RI

T23 - T25 FITTERS T36 - T84-34 ENGINEERS T112 - T114 HD VICES

Item No.	Description	EAN	Master Pack	Shelf Pack	LP Ex VAT £ / Item	RRP Inc VAT £ / Item	DISC CODE
T23C	Mainscrew with Handle (C), Nut (L), Nut Guide (M), & Screws (N)	0734442010920	-	1	156.66	187.99	IR (HT)
T25C	Mainscrew with Handle (C), Nut (L), Nut Guide (M), & Screws (N)	0734442012603	-	1	205.08	246.10	
T112C	Mainscrew with Handle (C), Nut (L), Nut Guide (M), & Screws (N)	0734442025207	-	1	219.31	263.17	
T114C	Mainscrew with Handle (C), Nut (L), Nut Guide (M), & Screws (N)	0734442025924	-	1	278.11	333.73	
T36C	Mainscrew with Handle (C), Nut (L), Nut Guide (M), & Screws (N)	0734442021841	-	1	190.27	228.32	
84C	Mainscrew with Handle (C), Nut (L), Nut Guide (M), & Screws (N)	0734442023647	-	1	224.58	269.50	
T23DK	Trigger Complete	0734442011408	-	1	60.48	72.58	
T25DK	Trigger Complete	0734442012962	-	1	72.31	86.77	
T112DK	Trigger Complete	0734442025801	-	1	73.33	88.00	
T114DK	Trigger Complete	0734442026402	-	1	111.42	133.70	
T36DK	Trigger Complete	0734442022329	-	1	70.58	84.70	
T84DK	Trigger Complete	0734442024002	-	1	78.43	94.12	
T23L	Half Nut (L), Guide (M) & Screws (N)	0734442011163	-	1	43.91	52.69	
T25L	Half Nut (L), Guide (M) & Screws (N)	0734442012849	-	1	48.86	58.63	
T112L	Half Nut (L), Guide (M) & Screws (N)	0734442025443	-	1	46.81	56.17	
T114L	Half Nut (L), Guide (M) & Screws (N)	0734442026167	-	1	78.75	94.50	
T36L	Half Nut (L), Guide (M) & Screws (N)	0734442022084	-	1	51.38	61.66	
T84L	Half Nut (L), Guide (M) & Screws (N)	0734442022688	-	1	42.54	51.05	
T230	Jaw Plates (pair) with Screws (P)	0734442011286	-	1	40.66	48.79	
T250	Jaw Plates (pair) with Screws (P)	0734442011521	-	1	50.44	60.53	
T1120	Jaw Plates (pair) with Screws (P)	0734442025566	-	1	62.88	75.46	
T1140	Jaw Plates (pair) with Screws (P)	0734442026280	-	1	114.05	136.86	
T360	Jaw Plates (pair) with Screws (P)	0734442022206	-	1	54.85	65.82	
T840	Jaw Plates (pair) with Screws (P)	0734442023883	-	1	61.70	74.04	

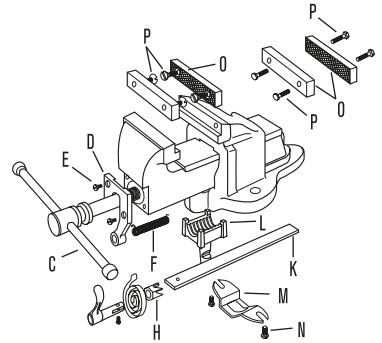

T1 - T8 MECHANICS' VICES

Item No.	Description	EAN	Master Pack	Shelf Pack	LP Ex VAT £ / Item	RRP Inc VAT £ / Item	DISC CODE
T1C	Mainscrew with Handle, Nut, Pin, Spring Washer & Pin (C) & (F)	0734442004561	-	1	50.35	60.42	IR (HT)
T3C	Mainscrew with Handle, Nut, Pin, Spring Washer & Pin (C) & (F)	0734442006121	-	1	76.42	91.70	
T4C	Mainscrew with Handle, Nut, Pin, Spring Washer & Pin (C) & (F)	0734442006961	-	1	116.60	139.92	
T5C	Mainscrew with Handle, Nut, Pin, Spring Washer & Pin (C) & (F)	0734442007807	-	1	133.83	160.60	
T6C	Mainscrew with Handle, Nut, Pin, Spring Washer & Pin (C) & (F)	0734442008521	-	1	137.19	164.63	
T8C	Mainscrew with Handle, Nut, Pin, Spring Washer & Pin (C) & (F)	0734442009009	-	1	148.81	178.57	
T1D	Pair of Jaw Plates with Screws	0734442004684	-	1	12.00	14.40	
T3D	Pair of Jaw Plates with Screws	0734442006244	-	1	18.32	21.98	
T4D	Pair of Jaw Plates with Screws	0734442007081	-	1	32.66	39.19	
T5D	Pair of Jaw Plates with Screws	0734442007920	-	1	32.91	39.49	
T6D	Pair of Jaw Plates with Screws	0734442008644	-	1	46.29	55.55	
T8D	Pair of Jaw Plates with Screws	0734442009481	-	1	76.02	91.22	

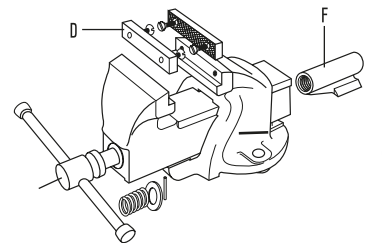

SPARE PARTS

T400300 PIPE VICE

Item No.	Description	EAN	Master Pack	Shelf Pack	LP Ex VAT £ / Item	RRP Inc VAT £ / Item	DISC CODE
T661053	Pipe vice jaws complete with nuts and washers for T400300		-	1	47.85	57.42	IR (HT)

T52 - T53 QUICK-RELEASE VICES

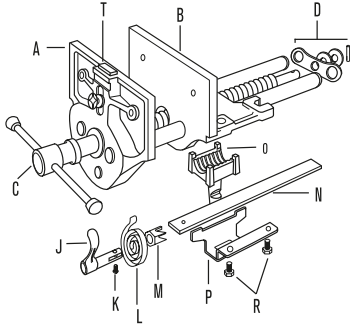

Item No.	Description	EAN	Master Pack	Shelf Pack	LP Ex VAT £ / Item	RRP Inc VAT £ / Item	DISC. CODE
T52EDA	Sliding Jaw (A)	0734442037323	-	1	108.49	130.19	IR (HT)
T5212EDA	Sliding Jaw (A)	0734442038528	-	1	144.17	173.00	
T53EDA	Sliding Jaw (A)	0734442009955	-	1	146.89	176.27	
T52EDC	Main Screw with Handle & Washers (E), Pin (F), Nut (O)	0734442037569	-	1	116.72	140.06	
T5212EDC	Main Screw with Handle & Washers (E), Pin (F), Nut (O)	0734442038764	-	1	151.96	182.35	
T53EDC	Main Screw with Handle & Washers (E), Pin (F), Nut (O)	0734442009962	-	1	151.96	182.35	
T52EDD	End Bracket with End Washers & Pin (F)	0734442037682	-	1	17.72	21.26	
T5212EDD	End Bracket with End Washers & Pin (F), also fits T53ED	0734442038887	-	1	20.81	24.97	
T52EDJN	Trigger Complete	0734442038405	-	1	30.40	36.48	
T5212EDJN	Trigger Complete (also fits T53ED)	0734442039488	-	1	32.86	39.43	
T52EDL	Trigger Spring & Nut (fits all sizes)	0734442038047	-	1	14.33	17.20	
T52EDO	Nut with Nut Guide & Screws	0734442038160	-	1	23.56	28.27	
T5212EDO	Nut with Nut Guide & Screws (also fits T53ED)	0734442039242	-	1	38.60	46.32	
T52EDT	Front Dog with Screws & Washers (fits all sizes)	0734442040927	-	1	14.33	17.20	

T52 - T53 PLAIN SCREW VICES

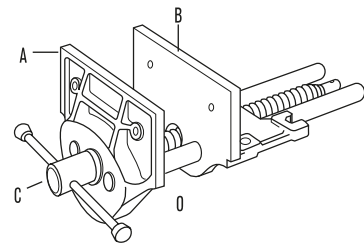

Item No.	Description	EAN	Master Pack	Shelf Pack	LP Ex VAT £ / Item	RRP Inc VAT £ / Item	DISC. CODE
T52PDC	Mainscrew with Handle & Pin (F) & Nut (O)	0734442047902	-	1	47.74	57.29	IR (HT)
T5212PDC	Mainscrew with Handle & Pin (F) & Nut (O)	0734442009924	-	1	60.10	72.12	
T53PDC	Mainscrew with Handle & Pin (F) & Nut (O)	0734442009979	-	1	60.10	72.12	
T52PDO	Nut	0734442009948	-	1	9.52	11.42	
T5212PDO	Nut (also fits T53PD)	0734442009931	-	1	12.02	14.42	

T92C - T93-1/2C & T96 HINGED PIPE VICES

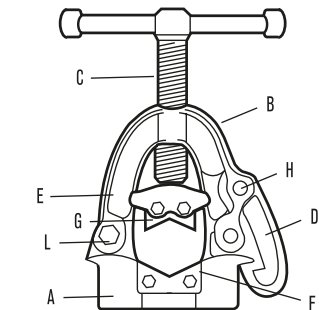

Item No.	Description	EAN	Master Pack	Shelf Pack	LP Ex VAT £ / Item	RRP Inc VAT £ / Item	DISC. CODE
T92CC	Main Screw with Handle	0734442160564	-	1	52.77	63.32	IR (HT)
T9212CC	Main Screw with Handle	0734442163442	-	1	66.63	79.96	
T92CD	Locking Hook & Rivet (H)	0734442160687	-	1	21.09	25.31	
T9212CD	Locking Hook & Rivet (H)	0734442163565	-	1	28.64	34.37	
T92CE	Jaw Clamp (Per Pair)	0734442160809	-	1	21.09	25.31	
T9312CE	Jaw Clamp (Per Pair)	0734442166320	-	1	40.90	49.08	
T92CF	Lower Jaws (Pair) with Bolts & Nuts	0734442160922	-	1	62.69	75.23	
T9312CF	Lower Jaws (Pair) with Bolts & Nuts	0734442165484	-	1	87.75	105.30	
T96F	Lower Jaws (Pair) with Bolts & Nuts	0734442168720	-	1	160.40	192.48	
T92CG	Upper Jaws with Bolts & Nuts	0734442162247	-	1	34.60	41.52	
T9312CG	Upper Jaws with Bolts & Nuts	0734442165606	-	1	47.83	57.40	
T96G	Upper Jaws with Bolts & Nuts	0734442168843	-	1	83.86	100.63	

T181C, T182C, T183C CHAIN PATTERN PIPE VICES

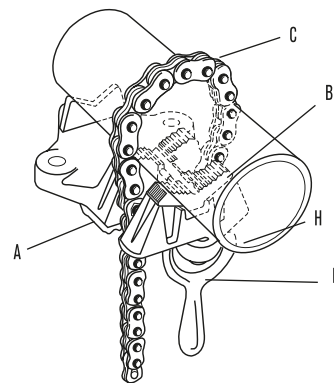

Item No.	Description	EAN	Master Pack	Shelf Pack	LP Ex VAT £ / Item	RRP Inc VAT £ / Item	DISC. CODE
T181CA	Base	0734442156369	-	1	47.83	57.40	IR (HT)
T182CA	Base	0734442156840	-	1	96.68	116.02	
T183CA	Base	0734442157328	-	1	193.43	232.12	
T181CB	Jaw Unit with Bolt	0734442159001	-	1	63.36	76.03	
T182CB	Jaw Unit with Bolt	0734442156963	-	1	136.52	163.82	
T183CB	Jaw Unit with Bolt	0734442157441	-	1	252.84	303.41	
T182CC	Chain with Screw	0734442157083	-	1	83.52	100.22	
T183CC	Chain with Screw	0734442159124	-	1	245.42	294.50	
T181CD	Handle with Nut	0734442156727	-	1	32.29	38.75	
T182CD	Handle with Nut	0734442157205	-	1	64.66	77.59	
T183CD	Handle with Nut	0734442157564	-	1	136.94	164.33	

Knives and Blades





BI-METAL UTILITY BLADES

Bi-Metal is formed by welding high-speed steel edge and spring steel, having the benefit of both types: **Safety & Longer Life.**

The blades are safer since they will not break under normal working conditions, they help reduce the risk of injury from breaking or shattering blades. And with Bi-Metal blades lasting longer than traditional carbon blades, they result in fewer blade changes which means fewer accidental cuts.

BI-METAL BLUE BLADES

1. SHATTERPROOF

The spring steel backing combined with dual hardening of the blade makes our blade more durable, and shatterproof.

2. LAST 3 TIMES LONGER*

More cuts for your money.

3. SPRING STEEL

Allows the blade to bend without accidentally breaking.

4. HIGH-SPEED STEEL

Delivers a hardened cutting edge that stay sharp 3x longer than traditional carbon blades*.

5. FITS MOST KNIVES

The two-notch blade design fits most utility knives.

6. SOFT SNAP TECHNOLOGY

For breaking a new edge confidently.



*vs IRWIN® carbon blades 10504245 / 10504561

BI-METAL BLUE TRAPEZOID BLADES

Item No.	Description	EAN	Master Pack	Shelf Pack	LP Ex VAT £ / Item	RRP Inc VAT £ / Item	DISC. CODE
10504240	Bi-Metal Blue Trapezoid blades - 5pk	5706915042405	25	5	2.88	3.46	IR (HT)
10504241	Bi-Metal Blue Trapezoid blades - 10pk	5706915042412	25	5	4.26	5.11	
10504243	Bi-Metal Blue Trapezoid blades - 100pk, Dispenser	5706915042436	5	1	42.45	50.94	

BI-METAL BLUE SAFETY BLADES

All the benefits of the Bi-Metal Trapezoid Blade but with a snub nose design which helps to reduce the risk of accidental puncture wounds.

Item No.	Description	EAN	Master Pack	Shelf Pack	LP Ex VAT £ / Item	RRP Inc VAT £ / Item	DISC. CODE
10505823	Bi-Metal 'Blue' Safety Trap Blade 5pk	5706915058239	25	5	2.94	3.53	IR (HT)
10505824	Bi-Metal 'Blue' Safety Trap Blade 50pk, Dispenser	5706915058246	5	1	22.12	26.54	

SNAP-OFF BI-METAL BLUE BLADES

Item No.	Description	EAN	Master Pack	Shelf Pack	LP Ex VAT £ / Item	RRP Inc VAT £ / Item	DISC. CODE
10507102	Bi-Metal 'Blue' Snap-Off Blade 18mm 5pk	5706915071023	-	10	3.90	4.68	IR (HT)
10507103	Bi-Metal 'Blue' Snap-Off Blade 18mm 8pk	5706915071030	-	10	5.62	6.74	
10507104	Bi-Metal 'Blue' Snap-Off Blade 18mm 50pk	5706915071047	-	2	34.44	41.33	
10507105	Bi-Metal 'Blue' Snap-Off Blade 18mm 10 x 8pk	5706915071054	50	10	5.45	6.54	



Bi-Metal Safety Blade - Not Pointed



UTILITY BLADES

CARBON STEEL 4POINT TRAPEZOID BLADES

This latest IRWIN® innovation combines the toughness of a traditional trapezoid blade with the increased blade tip life of a snap-off blade. Scored edges give the user 4 sharp points (vs. 2 points on a standard trapezoid blade) which doubles the life of the blade. The 4 notches enable the blade to be extended to maintain blade length after snapping off sections of the blade.



Item No.	Description	EAN	Master Pack	Shelf Pack	LP Ex VAT £ / Item	RRP Inc VAT £ / Item	DISC. CODE
10508107	4Point Carbon Steel Blade - 5pk	5706915081077	25	5	1.68	2.02	IR (HT)
10508108	4Point Carbon Steel Blade - 10pk	5706915081084	25	5	2.55	3.06	
10508110	4Point Carbon Steel Blade - 100pk, Dispenser	5706915081107	5	1	24.03	28.84	



CARBON STEEL BLADES

Item No.	Description	EAN	Master Pack	Shelf Pack	LP Ex VAT £ / Item	RRP Inc VAT £ / Item	DISC. CODE
10504245	Carbon Steel Blades - 5pk	5706915042450	-	5	1.40	1.68	IR (HT)
10504246	Carbon Steel Blades - 10pk	5706915042467	-	5	2.08	2.50	
10504247	Carbon Steel Blades - 100pk, Dispenser	5706915042474	-	1	20.61	24.73	



CARBON STEEL HOOKED BLADES

Item No.	Description	EAN	Master Pack	Shelf Pack	LP Ex VAT £ / Item	RRP Inc VAT £ / Item	DISC. CODE
10504249	Carbon Steel Hooked Blades - 5pk	5706915042498	-	5	1.85	2.22	IR (HT)
10504250	Carbon Steel Hooked Blades - 10pk	5706915042504	-	5	3.49	4.19	
10504251	Carbon Steel Hooked Blades - 100pk, Dispenser	5706915042511	-	1	30.16	36.19	



SNAP-OFF CARBON STEEL BLADES

Item No.	Description	EAN	Master Pack	Shelf Pack	LP Ex VAT £ / Item	RRP Inc VAT £ / Item	DISC. CODE
10504558	Carbon Steel Snap-Off Blade 25mm 5pk	5706915045581	-	5	2.56	3.07	IR (HT)
10504559	Carbon Steel Snap-Off Blade 25mm 10pk	5706915045598	-	5	4.90	5.88	
10504561	Carbon Steel Snap-Off Blade 18mm 5pk	5706915045611	-	5	2.61	3.13	
10504562	Carbon Steel Snap-Off Blade 18mm 10pk	5706915045628	-	5	3.72	4.46	
10504563	Carbon Steel Snap-Off Blade 18mm 50pk	5706915045635	-	1	11.29	13.55	
10504567	Carbon Steel Snap-Off Blade 9mm 10pk	5706915045673	-	5	2.60	3.12	
10506456	Carbon Steel Snap-Off Blade Bulk 18mm 100pk	5706915064568	-	1	17.77	21.32	



RETRACTABLE UTILITY KNIVES

A new collection of best-in-class knives developed from intensive research on the needs of professional users. This highly innovative range meets the high standards required by today's professional users – where safety, durability, convenience and comfort are the most important factors.

IRWIN® FK SERIES FK250 FOLDING KNIFE

FK SERIES

- 16° CUTTING ANGLE**
For ultimate comfort and control
- CAST FINGER GROOVES**
Allow for greater control when choking up on the knife
- WIRE STRIPPER**
- ERGONOMIC "TRIGGER GRIP" HANDLE DESIGN**
Provides greater control and makes cutting on the "pull" easier
- BUILT-IN BLADE STORAGE**
Stores up to 2 Utility Blades
- BELT CLIP**
For compact storage and use
- LINER LOCK**
For safe, one-handed use
- FOLD-OUT SCREW DRIVER & ADDITIONAL BIT STORAGE**
Fits 1" insert bits for quick fixes and provides additional tool versatility
Phillips #2 and Square #1 Included
- PATENTED BLADELOCK™ TECHNOLOGY**

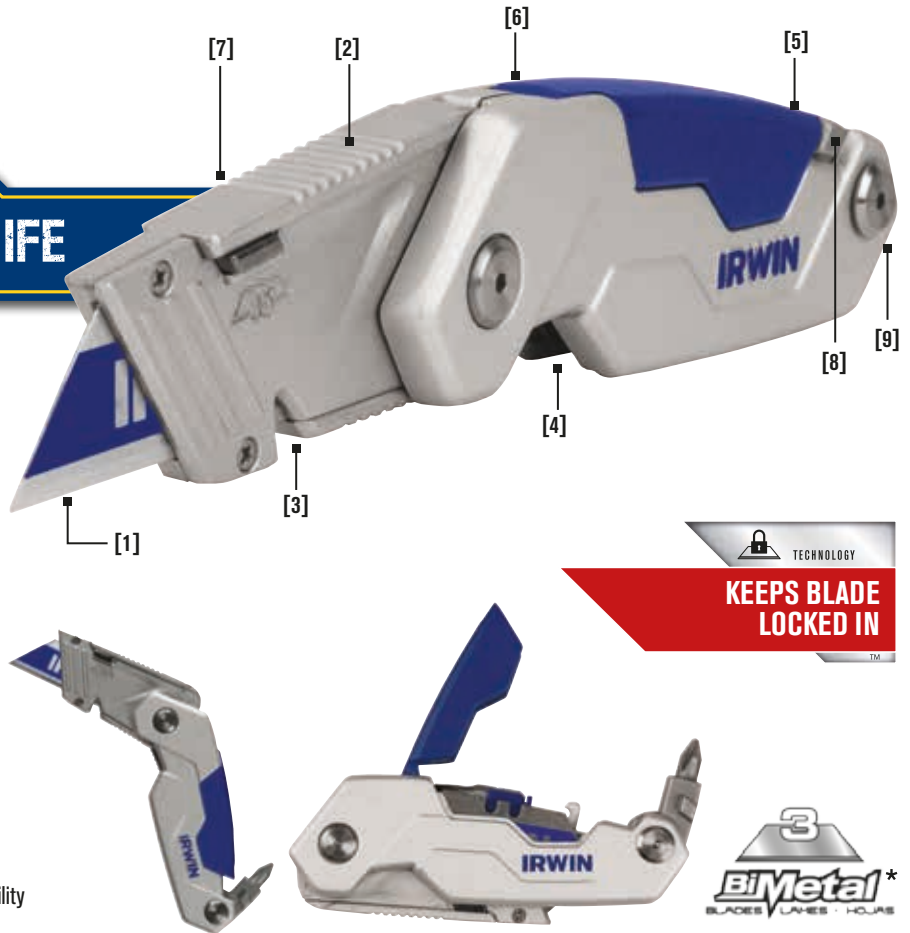

Included:



FK SERIES FOLDING KNIVES

Item No.	Description	EAN	Master Pack	Shelf Pack	LP Ex VAT £ / Item	RRP Inc VAT £ / Item	DISC. CODE
1888437	FK100 Folding Knife	5706918884378	-	5	13.32	15.98	IR (HT)
1888438	FK150 Folding Knife	5706918884385	-	5	15.31	18.37	
1888439	FK250 Folding Knife	5706918884392	-	5	19.14	22.97	

FOLDING KNIFE

This high-quality and compact knife design features a 45° quick-change mechanism to increase both productivity and safety. In addition, the knife features an anchored belt clip, extended thumb ledge, and wire stripper. The knife comes with a Bi-Metal utility blade.

Item No.	Description	EAN	Master Pack	Shelf Pack	LP Ex VAT £ / Item	RRP Inc VAT £ / Item	DISC. CODE
10507695	Folding Knife	5706915076950	30	10	13.32	15.98	IR (HT)

*FK150 & FK250 only. FK100 comes with 1 Blade included

RETRACTABLE UTILITY KNIVES

A new collection of best-in-class knives developed from intensive research on the needs of professional users. This highly innovative range meets the high standards required by today's professional users – where safety, durability, convenience and comfort are the most important factors.

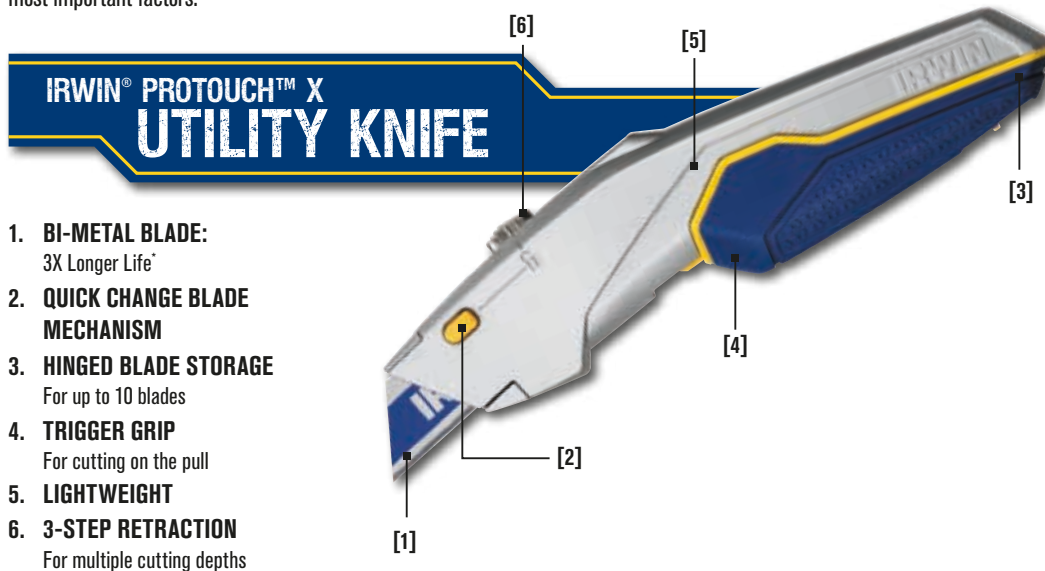

PROTOUCH™ X RETRACTABLE KNIFE

Ideal for many professional trades to be used in multiple applications, in particular roofing.

Item No.	Description	EAN	Master Pack	Shelf Pack	LP Ex VAT £ / Item	RRP Inc VAT £ / Item	DISC. CODE
10508104	ProTouch™ X Retractable Knife	5706915081046	25	5	11.45	13.74	IR (HT)

XP RETRACTABLE KNIFE

Item No.	Description	EAN	Master Pack	Shelf Pack	LP Ex VAT £ / Item	RRP Inc VAT £ / Item	DISC. CODE
10507404	XP Retractable Knife	5706915074048	40	8	15.35	18.42	IR (HT)

PROTOUCH™ RETRACTABLE KNIFE

Item No.	Description	EAN	Master Pack	Shelf Pack	LP Ex VAT £ / Item	RRP Inc VAT £ / Item	DISC. CODE
10504236	ProTouch™ Retractable Knife	5706915042368	-	5	11.45	13.74	IR (HT)

GENERAL CONSTRUCTION RETRACTABLE KNIFE

A lightweight and durable retractable knife to get all jobs done. The push and slide opening mechanism provides easy tool-free blade access - for quick blade changes. A solid and durable knife with secure parts to prevent dropping/losing components.

Item No.	Description	EAN	Master Pack	Shelf Pack	LP Ex VAT £ / Item	RRP Inc VAT £ / Item	DISC. CODE
10508105	General Contractor Retractable Knife	5706915081053	-	5	9.83	11.80	IR (HT)

PROFESSIONAL RETRACTABLE KNIFE

Item No.	Description	EAN	Master Pack	Shelf Pack	LP Ex VAT £ / Item	RRP Inc VAT £ / Item	DISC. CODE
10504238	Professional Retractable Knife	5706915042382	-	5	6.53	7.84	IR (HT)

RETRACTABLE KNIFE

Item No.	Description	EAN	Master Pack	Shelf Pack	LP Ex VAT £ / Item	RRP Inc VAT £ / Item	DISC. CODE
10507448	Retractable Knife	5706915074482	-	5	4.34	5.21	IR (HT)



Tool-free entry

Blade storage: holds up to 5 blades

Magnetic blade holder

ProTouch™ Grips for comfort and control



FIXED UTILITY KNIVES

PROTOUCH FIXED KNIFE

A feature-rich fixed knife featuring greater blade exposure, easy tool-free entry, convenient storage of 5 blades, magnetic blade retention, optimised cutting angle for minimal fatigue, and ProTouch™ for a secure grip and greater comfort.

Item No.	Description	EAN	Master Pack	Shelf Pack	LP Ex VAT £ / Item	RRP Inc VAT £ / Item	DISC. CODE
10504237	ProTouch Fixed Knife	5706915042375	-	5	9.27	11.12	IR (HT)

DRYWALLER FIXED KNIFE

This professional fixed knife is the ideal tool to be used in drywall cutting applications. It is specially made for working in dusty conditions that normally ruin tools. It is robust and lightweight and the slim nose for scoring makes this product unique.



Item No.	Description	EAN	Master Pack	Shelf Pack	LP Ex VAT £ / Item	RRP Inc VAT £ / Item	DISC. CODE
10508103	Drywaller Fixed Knife	5706915081039	-	5	9.27	11.12	IR (HT)

PROFESSIONAL FIXED KNIFE



Item No.	Description	EAN	Master Pack	Shelf Pack	LP Ex VAT £ / Item	RRP Inc VAT £ / Item	DISC. CODE
10504239	Professional Fixed Knife	5706915042399	-	5	4.36	5.23	IR (HT)

FIXED KNIFE



Item No.	Description	EAN	Master Pack	Shelf Pack	LP Ex VAT £ / Item	RRP Inc VAT £ / Item	DISC. CODE
10507449	Fixed Knife	5706915074499	25	5	3.38	4.06	IR (HT)

SPECIALITY KNIVES

SELF-RETRACTING KNIFE

Spring-return shuttle retracts the blade at the end of a cutting action to minimise risk of injury. Multi-functional design with two blade settings for normal use and as a box cutter. Cross-nose design eliminates nose splitting. Safer to work with using captive inner components and magnetic blade retention. No-tools-access to spare blades with a bale screw. Internal blade storage for up to five blades. Bi-Metal safety blade that last up to three times longer*



Item No.	Description	EAN	Master Pack	Shelf Pack	LP Ex VAT £ / Item	RRP Inc VAT £ / Item	DISC. CODE
10505822	Self Retractable Knife	5706915058222	-	5	6.73	8.08	IR (HT)

*versus IRWIN® carbon blades #10504245

SNAP-OFF KNIVES

PROTOUCH™ SNAP-OFF HEAVY DUTY KNIFE

A feature-rich, heavy-duty knife with manual screw tightening at the nose for user controlled blade security. Other features include cartridge for storing 2 blades, durable cast aluminium body with stainless steel blade guide, hinged end-cap, and ProTouch™ grip for a secure grip and greater comfort.



Item No.	Description	EAN	Master Pack	Shelf Pack	LP Ex VAT £ / Item	RRP Inc VAT £ / Item	DISC. CODE
10507106	ProTouch™ Screw Snap-Off Knife, 18mm	5706915071061	-	8	12.11	14.53	IR (HT)

Auto-load mechanism enables fast blade changes
Self-locking blade slider for fast blade adjustment on medium duty tasks

Blade storage for three blades inside the removable cartridge

Durable solid cast aluminium body with a steel blade guide

ProTouch™ grip provides excellent control
Slim nose design for maximum visibility of the cutting surface

Impact-resistant hinged end cap cannot be separated from body



PROTOUCH™ SNAP-OFF KNIFE

Item No.	Description	EAN	Master Pack	Shelf Pack	LP Ex VAT £ / Item	RRP Inc VAT £ / Item	DISC. CODE
10504553	ProTouch™ Screw Snap-Off Knife, 25mm	5706915045536	-	5	14.19	17.03	IR (HT)
10504555	ProTouch™ Snap-Off Knife 9mm	5706915045550	-	5	8.87	10.64	IR (HT)



PROFESSIONAL SNAP-OFF SCREW KNIFE

Screw thread for convenient user-controlled blade fixture. Blade storage for two blades inside the removable cartridge. Strong ABS body with steel blade guide. Texture grip provides improved control. Slim nose design for maximum visibility of the cutting surface. Hinged end cap cannot be separated from body

Item No.	Description	EAN	Master Pack	Shelf Pack	LP Ex VAT £ / Item	RRP Inc VAT £ / Item	DISC. CODE
10507580	Professional Screw Knife Bi-Metal Blade - 18mm	5706915075809	-	5	6.32	7.58	IR (HT)



SNAP-OFF SCREW KNIFE

Item No.	Description	EAN	Master Pack	Shelf Pack	LP Ex VAT £ / Item	RRP Inc VAT £ / Item	DISC. CODE
10508135	Snap-Off Screw Knife - 18mm	5706915081350	-	5	4.36	5.23	IR (HT)
10508136	Snap-Off Screw Knife - 25mm	5706915081367	-	5	10.92	13.10	IR (HT)



CARPET LAYER SNAP-OFF KNIFE

Solid cast aluminium body with steel blade guide provides more durability. Lightweight and durable handle for minimal fatigue. Screw thread for convenient user controlled blade fixture. Built-in metal carpet tucker for increased versatility.

Item No.	Description	EAN	Master Pack	Shelf Pack	LP Ex VAT £ / Item	RRP Inc VAT £ / Item	DISC. CODE
10507843	Carpet Layer Snap-Off Knife 18mm	5706915078435	25	5	5.39	6.47	IR (HT)



SNAP-OFF KNIFE

A popular knife format featuring self-locking blade adjustment together with a removable end-cap which can assist breakage of each blade segment.

Item No.	Description	EAN	Master Pack	Shelf Pack	LP Ex VAT £ / Item	RRP Inc VAT £ / Item	DISC. CODE
10506543	Snap-Off Knife 9mm	5706915065435	-	5	1.70	2.04	IR (HT)
10506546	Snap-Off Knife Bulk 9mm 24pk	5706915065466	120	24	1.62	1.94	
10506544	Snap-Off Knife 18mm	5706915065442	-	5	2.63	3.16	
10506547	Snap-Off Knife Bulk 18mm 24pk	5706915065473	120	24	2.31	2.77	
10507446	Snap-Off Knife Bulk with 18mm Bi-Metal Blade 100pk	5706915074468	-	100	3.27	3.92	





TAPE MEASURES

XP TAPE MEASURE RANGE

ProTouch
GRIPS



Item No.	Description	Blade Width	EAN	Master Pack	Shelf Pack	LP Ex VAT £ / Item	RRP Inc VAT £ / Item	DISC CODE
METRIC								
10507797	XP 5m Tape Measure	25mm	5706915978001	60	6	17.96	21.55	IR (HT)
10507798	XP 8m Tape Measure	27mm	5706915978018	48	6	24.71	29.65	
METRIC / IMPERIAL								
10507800	XP 5m/16ft Tape Measure	25mm	5706915078008	60	6	17.96	21.55	IR (HT)
10507801	XP 8m/26ft Tape Measure	27mm	5706915078015	48	6	24.71	29.65	

20x blade lifetime vs IRWIN® standard tape
Stand out: 3M: 1,2m / 5M: 2,3m / 8M: 2,3m
Double blade printing
3 Rivets + 1 eyelet

PROFESSIONAL TAPE MEASURE RANGE

Item No.	Description	Blade Width	EAN	Master Pack	Shelf Pack	LP Ex VAT £ / Item	RRP Inc VAT £ / Item	DISC CODE
METRIC								
10507790	Professional 3m Tape Measure	16mm	5706915077902	60	6	7.33	8.80	IR (HT)
10507791	Professional 5m Tape Measure	19mm	5706915077919	60	6	12.90	15.48	
10507792	Professional 8m Tape Measure	25mm	5706915077926	48	6	15.16	18.19	
10508059	Professional 5m Tape Measure, 12pcs Bulk	19mm	5706915080599	-	12	12.50	15.00	
10508060	Professional 8m Tape Measure, 12pcs Bulk	25mm	5706915080605	-	12	14.70	17.64	
METRIC / IMPERIAL								
10507793	Professional 3m/10ft Tape Measure	16mm	5706915077933	60	6	7.33	8.80	IR (HT)
10507794	Professional 5m/16ft Tape Measure	19mm	5706915077940	60	6	12.90	15.48	
10507795	Professional 8m/26ft Tape Measure	25mm	5706915077957	48	6	15.16	18.19	

2x blade lifetime vs. IRWIN® standard coating
Stand out: 3M: 1,4m / 5M: 1,8m / 8M: 2,3m
Hook magnets - 2 rivets + 1 eyelet
Double blade printing



STANDARD TAPE MEASURE RANGE

Item No.	Description	Blade Width	EAN	Master Pack	Shelf Pack	LP Ex VAT £ / Item	RRP Inc VAT £ / Item	DISC CODE
METRIC								
10507784	Standard 3m Tape Measure	13mm	5706915077841	60	6	3.13	3.76	IR (HT)
10507785	Standard 5m Tape Measure	19mm	5706915077858	60	6	5.04	6.05	
10507786	Standard 8m Tape Measure	25mm	5706915077865	48	6	10.40	12.48	
10508052	Standard 3m Tape Measure, 12pcs Bulk	13mm	5706915080520	-	12	3.04	3.65	
10508053	Standard 5m Tape Measure, 12pcs Bulk	19mm	5706915080537	-	12	4.89	5.87	
10508054	Standard 8m Tape Measure, 12pcs Bulk	25mm	5706915080544	-	12	9.89	11.87	
METRIC / IMPERIAL								
10507787	Standard 3m/10ft Tape Measure	13mm	5706915077872	60	6	3.13	3.76	IR (HT)
10507788	Standard 5m/16ft Tape Measure	19mm	5706915077889	60	6	5.04	6.05	
10507789	Standard 8m/26ft Tape Measure	25mm	5706915077896	48	6	10.19	12.23	
10508056	Standard 5m/16ft Tape Measure, 12pcs Bulk	19mm	5706915080568	-	12	4.89	5.87	
10508057	Standard 8m/26ft Tape Measure, 12pcs Bulk	25mm	5706915080575	-	12	9.60	11.52	

Stand out: 3M: 1,2m / 5M: 1,8m / 8M: 2,3m
Acrylic blade coating
2 rivets





CHALK REELS

The IRWIN® Strait-Line® chalk and reel range feature strong, durable reels with high-strength cord and a high chalk capacity. The chalk is available in a range of colours and refill sizes.

6X CHALK REEL



- Gear ratio 6:1** for faster line retraction.
- Impact resistant** die cast plates 3.5 x stronger than plastic reels
- Metal handle** 25 % stronger for durability
- Strong polymer line** 2x stronger for added durability
- Larger aggressive hook** for greater anchorage
- Thick, non-slip grip** for added comfort
- Clutch** for easy line release

Item No.	Description	EAN	Master Pack	Shelf Pack	LP Ex VAT £ / Item	RRP Inc VAT £ / Item	DISC. CODE
10507681	Strait-Line 6X Chalk Reel 30m/100'	5706915076813	-	6	11.60	13.92	IR (HT)

SPEED-LINE PRO CHALK REEL

Lightweight ABS impact resistant case. Retrieves chalk line 3.5 times faster than standard reels.

Item No.	Description	EAN	Master Pack	Shelf Pack	LP Ex VAT £ / Item	RRP Inc VAT £ / Item	DISC. CODE
10507676	Speed-Line PRO Chalk Reel 30m/100'	5706915076769	144	6	10.85	13.02	IR (HT)
10507677	Speed-Line PRO Chalk Reel 30m/100', 24 pcs, Bulk	5706915076776	-	24	10.46	12.55	IR (HT)



ALUMINIUM CHALK REEL

Heavy-duty case constructed of durable aluminium alloy.

Item No.	Description	EAN	Master Pack	Shelf Pack	LP Ex VAT £ / Item	RRP Inc VAT £ / Item	DISC. CODE
10507678	Aluminium Chalk Reel 15m/50'	5706915076783	144	6	9.89	11.87	IR (HT)
10507679	Aluminium Chalk Reel 30m/100'	5706915076790	144	6	10.23	12.28	IR (HT)
10507680	Aluminium Chalk Reel 30m/100', 24 pcs, Bulk	5706915076806	-	24	10.12	12.14	IR (HT)





CHALK REEL SETS

Item No.	Description	EAN	Master Pack	Shelf Pack	LP Ex VAT £ / Item	RRP Inc VAT £ / Item	DISC. CODE
10507684	6X Reel 30m / Blue Chalk 113g Value Pack	5706915076844	-	8	13.75	16.50	IR(HT)
10507682	Speed-Line PRO Reel 30m / Blue Chalk 113g Value Pack	5706915076820	72	3	12.74	15.29	
10507683	Aluminium Reel 30m / Blue Chalk 113g Value Pack	5706915076837	72	3	12.39	14.87	



REPLACEMENT LINES

Item No.	Description	EAN	Master Pack	Shelf Pack	LP Ex VAT £ / Item	RRP Inc VAT £ / Item	DISC. CODE
64550	Replacement Line 50' / 15m	0024721500182	144	6	2.12	2.54	IR(HT)
64610	Replacement Line 100' / 30m	0024721500199	144	6	2.61	3.13	
2031333	Replacement Line Nylon/Polyester 100' / 30m	0024721087393	144	6	3.97	4.76	



MARKING CHALK

Red Chalk - Outdoor permanent (up to 2 months). Blue Chalk - Standard indoor/outdoor (1 week)

Item No.	Description	EAN	Master Pack	Shelf Pack	LP Ex VAT £ / Item	RRP Inc VAT £ / Item	DISC. CODE
64801ZR	Blue Marking Chalk 4oz/113g	0024721500014	24	6	2.77	3.32	IR(HT)
64802	Red Marking Chalk 4oz/113g	0024721500052	24	6	2.77	3.32	
64901	Blue Marking Chalk 8oz/227g	0024721500076	24	6	3.78	4.54	
64902	Red Marking Chalk 8oz/227g	0024721500120	24	6	3.78	4.54	
65201	Blue Marking Chalk 2.5lbs/1.1kg	0024721652010	6	1	17.78	21.34	



CARPENTERS' PENCILS AND SHARPENERS

Item No.	Description	EAN	Master Pack	Shelf Pack	LP Ex VAT £ / Item	RRP Inc VAT £ / Item	DISC. CODE
233250	Carpenter Pencil Sharpener	0024721007087	-	25	4.09	4.91	IR(HT)
66300	Medium Pencil, Bulk 12pcs	0024721663009	144	12	0.80	0.96	
66305SL	Medium Pencil, Box 72pcs	0024721028150	1440	72	0.80	0.96	

CRAYONS



Item No.	Description	EAN	Master Pack	Shelf Pack	LP Ex VAT £ / Item	RRP Inc VAT £ / Item	DISC. CODE
66401ZR	Red Crayon, Bulk 12pk	0024721664013	-	1	0.80	0.96	IR(HT)
66404	Black Crayon, Bulk 12pk	0024721664044	-	1	0.80	0.96	
66406	Yellow Crayon, Bulk 12pk	0024721664068	-	1	0.80	0.96	
666012	Red Crayon, Carded 2 pk	0024721061904	-	12	2.31	2.77	
666042	Black Crayon, Carded 2 pk	0024721061935	-	12	2.31	2.77	
666062	Yellow Crayon, Carded 2 pk	0024721061959	-	12	2.31	2.77	





TOOL STORAGE

Professional end-users have high demands for their tools. IRWIN® understands these demands. Toughness and value are qualities you'll find in every IRWIN® toolbag and organiser.

SOFT-SIDE TOOL ORGANISER

Long enough to carry saws and levels with space and pockets for other tools. Size: 600 x 260 x 400mm.

Item No.	Description	EAN	Master Pack	Shelf Pack	LP Ex VAT £ / Item	RRP Inc VAT £ / Item	DISC. CODE
10505369	Soft-Sided Tool Organiser, Zipper	5706915053692	5	1	39.41	47.29	IR (HT)



BIGFOOT TOOL BAG

Versatile large capacity bag with a waterproof base, keeps plans and documents dry, even on wet or muddy ground. Size: 222 x 406 x 305mm.

Item No.	Description	EAN	Master Pack	Shelf Pack	LP Ex VAT £ / Item	RRP Inc VAT £ / Item	DISC. CODE
10506529	Bigfoot Tool Bag	5706915065299	4	4	24.10	28.92	IR (HT)



DOUBLE WIDE TOOL BAG

Two large compartments for hand tools, power tools and smaller compartments for screws and nails. As strong as a tool box but lightweight and easier to carry. Size: 140 x 508 x 324mm.

Item No.	Description	EAN	Master Pack	Shelf Pack	LP Ex VAT £ / Item	RRP Inc VAT £ / Item	DISC. CODE
10506531	Double Wide Tool Bag	5706915065312	4	4	46.20	55.44	IR (HT)



TOOL TOTE

Designed like the traditional metal tool tote but lightweight and easier to carry. Wide top opening for easy access and loops to carry blueprints or a level. Size: 210 x 419 x 260mm.

Item No.	Description	EAN	Master Pack	Shelf Pack	LP Ex VAT £ / Item	RRP Inc VAT £ / Item	DISC. CODE
10506532	Tool Tote	5706915065329	4	4	33.76	40.51	IR (HT)



PROFESSIONAL SOFT-SIDE TOOL ORGANISER

Small, lightweight and strong with zip fastening for security. Padded handle features reinforced stitching for extra strength. Extra wide opening provides easy access to all tools. Size: 440 x 285 x 190mm.

Item No.	Description	EAN	Master Pack	Shelf Pack	LP Ex VAT £ / Item	RRP Inc VAT £ / Item	DISC. CODE
10503820	PRO Soft Side Tool Organiser	5706915038200	4	4	24.60	29.52	IR (HT)



PROFESSIONAL LARGE TOOL ORGANISER

Large capacity storage with top opening for quick and easy access. False bottom provides separate storage for important items. Durable plastic bottom is water resistant. Reinforced handle features extra strength rivets. Size: 420 x 350 x 245mm.

Item No.	Description	EAN	Master Pack	Shelf Pack	LP Ex VAT £ / Item	RRP Inc VAT £ / Item	DISC. CODE
10503818	PRO Large Tool Organiser	5706915038187	4	4	44.29	53.15	IR (HT)

PROFESSIONAL UTILITY TOOL ORGANISER

Enough capacity to carry range of tools and accessories. Pockets and compartments designed to provide better organisation. Bottom made of tough wear resistant plastic. Reinforced rivets throughout for added durability. Size: 320 x 250 x 350mm.

Item No.	Description	EAN	Master Pack	Shelf Pack	LP Ex VAT £ / Item	RRP Inc VAT £ / Item	DISC CODE
10503819	PRO Utility Tool Organiser	5706915038194	4	4	25.82	30.98	IR (HT)



BUILDERS NAIL & TOOL POUCH

Consists of vertical tool or fastener storage that attaches directly to a belt. Designed to be worn for left or right hand access. Size: 290 x 305mm.

Item No.	Description	EAN	Master Pack	Shelf Pack	LP Ex VAT £ / Item	RRP Inc VAT £ / Item	DISC CODE
10506534	Builders Nail & Tool Pouch	5706915065343	25	5	17.06	20.47	IR (HT)



ELECTRICIAN'S UTILITY POUCH

Electrician's utility pouch, designed for left- or right-handed use. Back wall slots for long handled tools. Front pockets for smaller tools. Size: 190 x 290mm.

Item No.	Description	EAN	Master Pack	Shelf Pack	LP Ex VAT £ / Item	RRP Inc VAT £ / Item	DISC CODE
10506535	Electrician's Utility Pouch	5706915065350	25	5	15.75	18.90	IR (HT)



PROFESSIONAL STRUCTURAL FOAM TOOLBOX

A heavy-duty structural foam, unlike most plastic or metal tool boxes, this box will stand years of use and abuse. Size: 760 x 365 x 320mm

Item No.	Description	EAN	Master Pack	Shelf Pack	LP Ex VAT £ / Item	RRP Inc VAT £ / Item	DISC CODE
10503817	PRO Structural Foam Toolbox	5706915038170	4	4	66.94	80.33	IR (HT)



TOOL STORAGE



PROFESSIONAL KNEEPADS

I-GEL™ KNEEPADS

These comfortable and safe kneepads are made of perforated Neoprene material with impact resistant I-Gel inserts. The double straps do not restrict blood flow and the pads are notched for comfort when standing.



Item No.	Description	EAN	Master Pack	Shelf Pack	LP Ex VAT £ / Item	RRP Inc VAT £ / Item	DISC. CODE
10503830	I-Gel™ Kneepads	5706915038309	6	6	28.14	33.77	IR (HT)

ALL-TERRAIN KNEEPADS

Wide-body keeps stance more stable on uneven surfaces. Foam cushion under pad protects knee from rough surfaces.

Item No.	Description	EAN	Master Pack	Shelf Pack	LP Ex VAT £ / Item	RRP Inc VAT £ / Item	DISC. CODE
10503831	All-Terrain Kneepads	5706915038316	6	6	21.37	25.64	IR (HT)

SWIVEL-FLEX KNEEPADS

Convex cap design provides better pivoting and less resistance, giving greater manoeuvrability across textured surfaces.

Item No.	Description	EAN	Master Pack	Shelf Pack	LP Ex VAT £ / Item	RRP Inc VAT £ / Item	DISC. CODE
10503832	Swivel-Flex Kneepads	5706915038323	6	6	14.64	17.57	IR (HT)



TOOL STORAGE & WORKWEAR



PROFESSIONAL WORK GLOVES

The IRWIN® professional work gloves protect hands in jobsite environments. Machine washable, IRWIN® work gloves feature wrist straps for easy size adjustment.

GENERAL CONSTRUCTION GLOVES

Two layers of synthetic suede on palm, thumb and fingers for comfort and extended wear. Rubberised finger tips for better gripping. Knuckles padded with perforated Neoprene



Item No.	Description	EAN	Master Pack	Shelf Pack	LP Ex VAT £ / Item	RRP Inc VAT £ / Item	DISC. CODE
10503822	General Construction Gloves, L	5706915038224	24	6	23.64	28.37	IR (HT)
10503823	General Construction Gloves, XL	5706915038231	24	6	23.64	28.37	



EXTREME CONDITIONS GLOVES

Item No.	Description	EAN	Master Pack	Shelf Pack	LP Ex VAT £ / Item	RRP Inc VAT £ / Item	DISC. CODE
10503824	Extreme Conditions Gloves, L	5706915038248	24	6	23.09	27.71	IR (HT)
10503825	Extreme Conditions Gloves, XL	5706915038255	24	6	23.09	27.71	



HEAVY-DUTY JOBSITE GLOVES

Grip-reinforced palm, thumb and fingertips for extra durability and protection. Designed for harsh applications and rough materials. Knuckles padded with perforated Neoprene.

Item No.	Description	EAN	Master Pack	Shelf Pack	LP Ex VAT £ / Item	RRP Inc VAT £ / Item	DISC. CODE
10503826	Heavy-Duty Jobsite Gloves, L	5706915038262	24	6	21.37	25.64	IR (HT)
10503827	Heavy-Duty Jobsite Gloves, XL	5706915038279	24	6	21.37	25.64	



CARPENTER GLOVES

Open finger design, allows for better dexterity. TechnoGrip® reinforced palm, thumb and fingertips for extra durability and protection. Knuckles padded with perforated Neoprene.

Item No.	Description	EAN	Master Pack	Shelf Pack	LP Ex VAT £ / Item	RRP Inc VAT £ / Item	DISC. CODE
10503828	Carpenter Gloves, L	5706915038286	24	6	20.25	24.30	IR (HT)
10503829	Carpenter Gloves, XL	5706915038293	24	6	20.25	24.30	



Formers supported on both sides so they will not twist under heavy loading

Durable, hardwearing steel rollers last much longer than aluminium

Solid lug allows the machine to be held firmly between vice jaws

Heavy gauge formers won't lose their shape
15 & 22mm Formers have degree marks on the casting for 'at-a glance' accuracy

Flat edges to the bracket arm also allow the GLM to be used in workshop vice for convenient bending

Steel inserts to the bungs eliminate piercing and increase durability To assist the bending of large diameter tube the IRWIN® Hilmor® GLM has

pimpled bungs on the bending levers which prevent the arms slipping if they are used on the floor



PIPE AND TUBE BENDERS

With the IRWIN® Hilmor® range of tube benders, you can be ready to tackle any job with ease. All machines feature precision tooling to give a smooth, accurate bend every time across a large range of sizes.

GLM HAND BENDING MACHINE AND SPARE PART

The IRWIN® Hilmor® GLM hand bender has a maximum capacity of 22mm copper and 15mm stainless steel and can also bend 12, 15 & 18mm copper. The GLM is also available with imperial tooling. The design of the IRWIN® Hilmor® GLM with a straight arm makes it the strongest machine available.



Item No.	Description	EAN	Master Pack	Shelf Pack	LP Ex VAT £ / Item	RRP Inc VAT £ / Item	DISC. CODE
T591057	GLM Hand Bending Machine 15/22mm	0686182000016	-	1	99.42	119.30	IH
T660032	Hook stop and bolt for GLM	0686182001006	-	1	30.39	36.47	IR (HT)

MULTI-MINI HAND BENDER

The IRWIN® Hilmor® Multi-Mini bender is a small lightweight bender that is able to bend 6, 8 & 10mm copper tube in one convenient machine. The Multi-Mini is able to produce bends of 180°

Item No.	Description	EAN	Master Pack	Shelf Pack	LP Ex VAT £ / Item	RRP Inc VAT £ / Item	DISC. CODE
T676810	Multi-Mini Tube Bender 6, 8, 10mm (Root Radii 22.5, 20 & 15mm)	0686182000061	-	8	52.64	63.17	IH

ROLLER PIPE CUTTERS

Designed to cut steel pipe, this tool has one fast cutting wheel and two wide rollers. As well as keeping the cutter squarely on track, the rollers smooth down the surface leaving a clean-cut ready for jointing or threading.

Item No.	Description	EAN	Master Pack	Shelf Pack	LP Ex VAT £ / Item	RRP Inc VAT £ / Item	DISC. CODE
T202	Roller Pipe Cutter, 1/8"-2" (10-60mm)	0734442115564	-	1	181.81	218.17	RI
T202DF	Roller with Pin T202	0734442137641	-	1	18.81	22.57	
T202EF	Wheel with Pin T202	0734442131526	-	1	23.43	28.12	

TUBE CUTTERS & SPARE WHEELS

Item No.	Description	EAN	Master Pack	Shelf Pack	LP Ex VAT £ / Item	RRP Inc VAT £ / Item	DISC. CODE
T20030C	Tube Cutter, 3-30mm	0734442118084	-	6	25.95	31.14	IH
T20045	Tube Cutter, 15-45mm	0734442118183	-	4	23.54	28.25	
THPC022	Tube Cutter, 22mm Plastic Body	0686182000467	-	12	14.21	17.05	
T20030CD	Wheel for Tube Cutter T20030C	0734442117964	-	1	5.05	6.06	IR (HT)
T20045D	Wheel for Tube Cutter T20045	0734442132004	-	1	10.14	12.17	

PLASTIC PIPE CUTTERS

Item No.	Description	EAN	Master Pack	Shelf Pack	LP Ex VAT £ / Item	RRP Inc VAT £ / Item	DISC. CODE
T850026	26mm Plastic Pipe Cutter	0686182000221	-	10	19.70	23.64	RI
10507485	45mm PVC Tube Cutter	5706915074857	-	4	34.72	41.66	

TUBE BENDERS

Item No.	Description	EAN	Master Pack	Shelf Pack	LP Ex VAT £ / Item	RRP Inc VAT £ / Item	DISC. CODE
T210	Mini Tube Bender 3, 4, 6mm Copper	0734442144052	48	4	27.11	32.53	IH

MANUAL BENDING MACHINES

EL RANGE CONDUIT BENDING MACHINES AND SPARE PARTS

The IRWIN® Hilmor® EL range is easily portable and the EL25 is the lightest conduit bender available and will fit into most car boots.

Item No.	Description	EAN	Master Pack	Shelf Pack	LP Ex VAT £ / Item	RRP Inc VAT £ / Item	DISC. CODE
T090700	EL25 Machine & Pipe Vice	0686182000580	-	1	499.95	599.94	IH
T090700B	EL25 & Vice + 20 / 25mm Formers	0686182000566	-	1	655.83	787.00	
T113100D	EL32 & Vice + 20 / 25 / 32mm Formers	0686182000634	-	1	772.91	927.49	IR (HT)
T090751	Stop bar for EL25	0686182000726	-	1	44.94	53.93	
T620204	Stop bar for EL32	0686182000917	-	1	46.36	55.63	
T660073	Bolt and stop bar pivot assembly for EL25, EL32.	5706915073157	-	1	28.00	33.60	
T620103	Tube stop for EL25, EL32	0686182000702	-	1	24.72	29.66	
T120422	Centre pin for EL25, EL32	0686182000740	-	1	16.88	20.26	
T113112	Bending lever with roller for EL25, EL32	0686182000733	-	1	155.32	186.38	
T102010	Grooved roller for EL25, EL32	0686182000696	-	1	23.30	27.96	
T120465	Roller pin for EL25, EL32	0686182000757	-	1	23.36	28.03	
T090757	Safety pin and chain for EL25, EL32	0686182000689	-	1	13.67	16.40	
T529827	"Terry" retaining pins (in packs of 5 pins) for EL25, EL32	0686182000771	-	1	6.07	7.28	
T201030	Extension tube for EL32	0686182000931	-	1	43.58	52.30	
T661053	Pipe vice jaws complete with nuts and washers for T400300	0686182000788	-	1	47.85	57.42	



CONDOBEND AND SPARE PARTS

The unique IRWIN® Hilmor® Condebend is a 20 & 25mm conduit bender all-in-one. Complete with in-built carrying handle and precision tough aluminium former that makes it an easily portable machine.

Item No.	Description	EAN	Master Pack	Shelf Pack	LP Ex VAT £ / Item	RRP Inc VAT £ / Item	DISC. CODE
T702025	Condebend (Std Vice)	0686182000795	-	1	774.68	929.62	IH
T660084	Centre pin and circlips for Condebend	0686182000856	-	1	15.02	18.02	IR (HT)
T660082	Roller pin and circlip for Condebend	0686182000832	-	1	22.57	27.08	
T700032	Hook assembly for Condebend	0686182000863	-	1	65.88	79.06	



CM RANGE COPPER BENDING MACHINES AND SPARE PARTS

The CM range of tube benders are easily portable with in-built carrying handles, they are used with aluminium formers making them the lightest machines available.

Item No.	Description	EAN	Master Pack	Shelf Pack	LP Ex VAT £ / Item	RRP Inc VAT £ / Item	DISC. CODE
T620100A	CM35 Machine only	0686182002706	-	1	384.60	461.52	IH
T620100J	CM35 & 15, 22, 28mm Tooling	0686182000078	-	1	659.85	791.82	
T630500A	CM42 Machine only	0686182002843	-	1	408.71	490.45	IR (HT)
T620204	Stop bar for CM35	0686182000917	-	1	46.36	55.63	
T630520	Stop bar for CM42	0686182000924	-	1	55.35	66.42	
T660073	Bolt and stop bar pivot assembly for CM35, CM42.	5706915073157	-	1	28.00	33.60	
T620103	Tube stop for CM35, CM42	0686182000702	-	1	24.72	29.66	
T120422	Centre pin for CM35, CM42	0686182000740	-	1	16.88	20.26	
T630519	Bending lever assembly for CM35, CM42	0686182000900	-	1	226.16	271.39	
T090757	Safety pin and chain for CM35, CM42	0686182000689	-	1	13.67	16.40	
T529827	"Terry" retaining pins (in packs of 5 pins) for CM35, CM42	0686182000771	-	1	6.07	7.28	
T201030	Extension tube for CM42	0686182000931	-	1	43.58	52.30	



HEAVY-DUTY UNIVERSAL PORTABLE BENDER AND SPARE PARTS

Item No.	Description	EAN	Master Pack	Shelf Pack	LP Ex VAT £ / Item	RRP Inc VAT £ / Item	DISC. CODE
TUL223	Universal Portable Bender, Machine Only	0734442144489	6	1	411.63	493.96	IH
T223B	Tube locator arm (Stop bar) For TUL223	0734442172680	-	1	34.91	41.89	IR (HT)
T620103	Tube stop for TUL223	0686182000702	-	1	24.72	29.66	
T220D	Tube locator arm pin with spring for TUL223	0734442171003	-	1	9.31	11.17	
T220H	Quadrant assembly for TUL223.	0734442171362	-	1	51.12	61.34	
T223J	Quadrant locknut, washer and spring for TUL223.	0734442159483	-	1	6.39	7.67	

PIPE VICE

Item No.	Description	EAN	Master Pack	Shelf Pack	LP Ex VAT £ / Item	RRP Inc VAT £ / Item	DISC. CODE
T400300	Pipe Vice	0686182000764	-	1	124.10	148.92	IH

FORMERS AND GUIDES SELECTOR

Formers and guides are not supplied with IRWIN® Hilmor® bending machines. Simply read along the line to select the correct former or former and guides for the application. These capabilities are maximum recommended capacities.

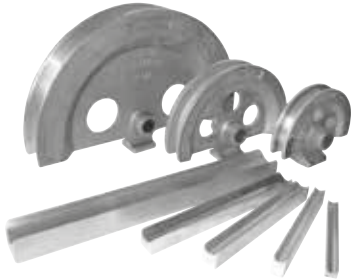

Material	Formers & Guides	MANUAL BENDERS									
		IRWIN hilmor									
		T210	TUL223	MULTI MINI	GLM	EL25	EL32	CM35	CM42	K3B	Condebend T702025
Copper	3mm Former	Fixed									
	3mm Guide	Fixed									
	4mm Former	Fixed									
	4mm Guide	Fixed									
	6mm Former	Fixed		Fixed							
	6mm Guide	Fixed		Fixed							
	8mm Former			Fixed							
	8mm Guide			Fixed							
	10mm Former			Fixed							
	10mm Guide			Fixed							
	12mm Former		TF3A1212					TF3A1212	TF3A1212	TF3A1212	
	12mm Guide		T560865		T560851			T560865	T560865	T560865	
	15mm Former		T563214		T591023			T563214	T563214	T563214	
	15mm Guide		T560852		T560852			T560852	T560852	T560852	
	22mm Former		T563216		T591027			T563216	T563216	T563216	
	22mm Guide		T560853		T560853			T560853	T560853	T560853	
	28mm Former		T563217					T563217	T563217	T563217	
	28mm Guide		T561006					T561006	T561006	T561006	
	35mm Former		T563218					T563218	T563218	T563218	
	35mm Guide		T561008					T561008	T561008	T561008	
42mm Former		T563219						T563219	T563219		
42mm Guide		T560053						T560053	T560053		
1/2" nb Former		TF3B1521					TF3B1521	TF3B1521			
1/2" nb Guide		TG3A1521					TG3A1521	TG3A1521			
3/4" nb Former		TF3F2156									
3/4" nb Guide		TG3A2156									
1/2" od Former		T563400					T563400	T563400	T563400		
1/2" od Guide		T563342		T563342			T563342	T563342	T563342		
5/8" Former		T563401			T563251	T563251	T563401	T563401	T563401		
5/8" Guide		T591032		T591032	T560791	T560791	T591032	T591032	T591032		
3/4" od Former		T563402			T563402	T563402	T563402	T563402	T563402		
3/4" od Guide		T563409		T591077	T563409	T563409	T563409	T563409	T563409		
7/8" Former		T563403					T563403	T563403	T563403		
7/8" Guide		T591050		T591050			T591050	T591050	T591050		
1" od Former		T560745			T563084	T563084	T560745	T560745	T560745		
1" od Guide		T560855			T560855	T560855	T560855	T560855	T560855		
1" nb Former		TF3K2832									
1" nb Guide		TG3A2832									
1-1/8" Former							T563404	T563404	T563404		
1-1/8" Guide							T563411	T563411	T563411		
1-1/4" od Former		T563252				T563252	T563252	T563252	T563252		
1-1/4" od Guide						T560794					
1-1/4" nb Former		TF3M3467									
1-3/8" od Former		T563218					T563218	T563218	T563218		
1-3/8" od Guide		T563412					T563412	T563412	T563412		
1-5/8" Former		T563406						T563406	T563406		
1-5/8" Guide		T563413						T563413	T563413		
Irish F&G's for Copper	1/2" od Former		T560747		T591020	T560747	T560747	T560747	T560747		
	1/2" od Guide		T560801		T560874			T560801	T560801		
	3/4" od Former		T560748		T591022	T560748	T560748	T560748	T560748		
	3/4" od Guide		T560875		T560875			T560875	T560875		
	1" od Former		T560749			T560749	T560749	T560749	T560749		
	1" od Guide		T560803					T560803	T560803		
1-1/4" od Former		T560750					T560750	T560750			
1-1/4" od Guide		T560804					T560804	T560804			
1-1/2" od Former		T560936					T560936	T560936			
1-1/2" od Guide		T560926					T560926	T560926			

Material	Formers & Guides	MANUAL BENDERS									
											
		210	TUL223	MULTI MINI	GLM	EL25	EL32	CM35	CM42	K3B	Condubend 702025
Conduit	16mm Former Guide		T563251 T560791			T563251 T560791	T563251 T560791	T563251 T560791	T563251 T560791	T563251 T560791	
	20mm Former Guide		T563082 T562521			T563082 T562521	T563082 T562521	T563082 T562521	T563082 T562521	T563082 T562521	T700024
	25mm Former Guide		T563084 T562523			T563084 T562523	T563084 T562523	T563084 T562523	T563084 T562523	T563084 T562523	T700024
	32mm Former Guide		T563252 T560794				T563252 T560794				
	5/8" od Former Guide		T563401 T591032			T563251 T560791	T563251 T560791				
	3/4" od Former Guide		T563402 T563409			T563402 T563409	T563402 T563409				
	1" od Former Guide		T560745 T560855			T563084 T560855	T563084 T560855				
	1-1/4" od Former Guide		T563252 T560794				T563252 T560794				

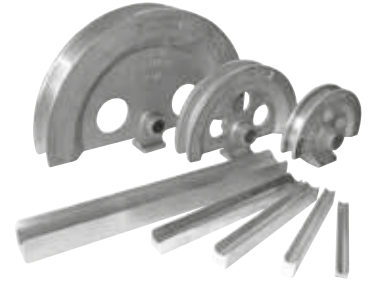

Material to Bend	Machines Available & Maximum Capacities							
	GLM Range Former	Mini Bender Former	CM35	CM42	K3B	EL25	EL32	Condubend
Light Gauge Non-Ferrous & Electrical Conduit to BS31	-	-	1-1/4"	1-1/4"	1-1/4"	-	-	-
Electrical Conduit to BS4568 Part	-	-	-	-	-	25mm	32mm	25mm
Copper to BSEN1057 R250 (Half-Hard) formerly BS2871 Part 1 & 2	22mm	15mm	35mm	42mm	42mm	-	-	-
Stainless Steel to BS4182	15mm	15mm	28mm	35mm	35mm	-	-	-
Mild Steel to BS4182	15mm	-	28mm	35mm	35mm	-	-	-
Plastic Covered Pipe	22mm	-	22mm	32mm	32mm	-	-	-

FORMERS AND GUIDES FOR MANUAL BENDERS

FORMERS FOR COPPER



Size	Item No.	Suitable for use with:	EAN	Master Pack	Shelf Pack	LP Ex VAT £ / Item	RRP Inc VAT £ / Item	DISC. CODE
12mm	TF3A1212	TUL223/CM Range/K3B	0734442145325	-	1	47.67	57.20	H
15mm	T591023	GLM	0686182000023	-	1	51.60	61.92	
15mm	T563214	TUL223/CM Range/K3B	0686182000092	-	1	54.83	65.80	
22mm	T591027	GLM	0686182000030	-	1	64.47	77.36	
22mm	T563216	TUL223/CM Range/K3B	0686182000108	-	1	73.46	88.15	
28mm	T563217	TUL223/CM Range/K3B	0686182000115	-	1	97.64	117.17	
35mm	T563218	TUL223/CM Range/K3B	0686182000122	-	1	132.05	158.46	
42mm	T563219	TUL223/CM42/K3B	0686182000139	-	1	186.71	224.05	
1/2" nb	TF3B1521	TUL223/CM Range	0734442144724	-	1	103.28	123.94	
1/2" od	T563400	TUL223/CM Range/K3B	0686182002775	-	1	46.16	55.39	
5/8"	T563251	EL Range	0686182000641	-	1	55.56	66.67	
5/8"	T563401	TUL223/CM Range/K3B	0686182002867	-	1	47.59	57.11	
3/4" od	T563402	TUL223/EL Range/CM Range/K3B	0686182002621	-	1	68.72	82.46	
7/8"	T563403	TUL223/CM Range/K3B	0686182002744	-	1	70.67	84.80	
1" od	T560745	TUL223/CM Range/K3B	0734442180142	-	1	88.01	105.61	
1" od	T563084	EL Range	0686182000665	-	1	97.88	117.46	
1-1/8"	T563404	CM Range/K3B	0686182002287	-	1	84.20	101.04	
1-1/4" od	T563252	TUL223/EL32/CM Range/K3B	0686182000672	-	1	109.04	130.85	
1-1/4" nb	TF3M3467	TUL223	0734442145080	-	1	134.98	161.98	
1-3/8" od	T563218	TUL223/CM Range/K3B	0686182002362	-	1	132.05	158.46	
1-5/8"	T563406	TUL223/CM42/K3B	0686182002751	-	1	159.17	191.00	

IRISH FORMERS FOR COPPER

Size	Item No.	Suitable for use with:	EAN	Master Pack	Shelf Pack	LP Ex VAT £ / Item	RRP Inc VAT £ / Item	DISC. CODE
1/2"	T560747	TUL223/EL Range/CM Range	0686182002317	-	1	50.94	61.13	H
1/2"	T591020	GLM	0686182002256	-	1	54.01	64.81	
3/4"	T560748	TUL223/EL Range/CM Range	0686182002331	-	1	64.48	77.38	
3/4"	T591022	GLM	0686182002768	-	1	63.79	76.55	
1"	T560749	TUL223/EL Range/CM Range	0686182002126	-	1	78.35	94.02	
1-1/4"	T560750	TUL223/EL Range/CM Range	0734442180234	-	1	126.10	151.32	
1-1/2"	T560936	TUL223/EL Range/CM Range	0686182002461	-	1	168.41	202.09	

FORMERS FOR CONDUIT

Size	Item No.	Suitable for use with:	EAN	Master Pack	Shelf Pack	LP Ex VAT £ / Item	RRP Inc VAT £ / Item	DISC. CODE
16mm	T563251	TUL223/EL Range/CM Range/K3B	0686182000641	-	1	55.56	66.67	H
20mm	T563082	TUL223/EL Range/CM Range/K3B	0686182000658	-	1	70.12	84.14	
20 / 25mm	T700024	CONDUBEND	0686182000849	-	1	151.82	182.18	
25mm	T563084	TUL223/EL Range/CM Range/K3B	0686182000665	-	1	97.88	117.46	
32mm	T563252	TUL223/EL32	0686182000672	-	1	109.04	130.85	
5/8" od	T563401	TUL223	0686182002867	-	1	47.59	57.11	
5/8" od	T563251	EL Range	0686182000641	-	1	55.56	66.67	
3/4" od	T563402	TUL223/EL Range	0686182002621	-	1	68.72	82.46	
1" od	T560745	TUL223	0734442180142	-	1	88.01	105.61	
1" od	T563084	EL Range	0686182000665	-	1	97.88	117.46	
1-1/4" od	T563252	EL 32	0686182000672	-	1	109.04	130.85	

GUIDES FOR COPPER

Size	Item No.	Suitable for use with:	EAN	Master Pack	Shelf Pack	LP Ex VAT £ / Item	RRP Inc VAT £ / Item	DISC. CODE
12mm	T560865	TUL223/CM Range/K3B	0686182001280	-	1	13.76	16.51	IH
15mm	T560852	GLM/CM Range/K3B	0686182000047	-	1	15.05	18.06	
22mm	T560853	GLM/CM Range/K3B	0686182003062	-	1	21.76	26.11	
28mm	T561006	TUL223/CM Range/K3B	0686182000160	-	1	30.10	36.12	
35mm	T561008	TUL223/CM Range/K3B	0686182000177	-	1	49.83	59.80	
42mm	T560053	TUL223/CM42/K3B	0686182000184	-	1	57.69	69.23	
1/2" nb	TG3A1521	TUL223/CM Range	0734442146643	-	1	15.32	18.38	
1/2" od	T563342	GLM/TUL223/CM Range/K3B	0686182001464	-	1	15.44	18.53	
5/8"	T560791	EL Range	0686182002164	-	1	29.67	35.60	
5/8"	T591032	TUL223/GLM/CM Range/K3B	0686182001471	-	1	25.57	30.68	
3/4" od	T563409	TUL223/EL Range/CM Range/K3B	0686182002393	-	1	34.55	41.46	
3/4" nb	TG3A2156	TUL223	0734442146766	-	1	15.88	19.06	
7/8"	T591050	TUL223/GLM/CM Range/K3B	0686182001501	-	1	37.13	44.56	
1" od	T560855	TUL223/EL Range/CM Range/K3B	0686182002041	-	1	60.93	73.12	
1" nb	TG3A2832	TUL223	0734442146889	-	1	29.40	35.28	
1-1/8"	T563411	CM Range/K3B	0686182002263	-	1	36.15	43.38	
1-1/4" od	T560794	TUL223/EL32/CM Range/K3B	0686182002218	-	1	71.22	85.46	
1-3/8" od	T563412	TUL223/CM Range/K3B	0686182002348	-	1	43.91	52.69	
1-5/8"	T563413	TUL223/CM42/K3B	0686182002270	-	1	58.91	70.69	



IRISH GUIDES FOR COPPER









Size	Item No.	Suitable for use with:	EAN	Master Pack	Shelf Pack	LP Ex VAT £ / Item	RRP Inc VAT £ / Item	DISC. CODE
1/2"	T560874	GLM	0686182002584	-	1	15.00	18.00	IH
3/4"	T560875	TUL223/GLM/EL Range/CM Range	0686182002591	-	1	20.36	24.43	
1"	T560803	TUL223/CM Range	0734442181385	-	1	28.05	33.66	
1-1/4"	T560804	TUL223/CM Range	0686182002577	-	1	57.47	68.96	
1-1/2"	T560926	TUL223/CM Range	0686182002249	-	1	87.80	105.36	

GUIDES FOR CONDUIT

Size	Item No.	Suitable for use with:	EAN	Master Pack	Shelf Pack	LP Ex VAT £ / Item	RRP Inc VAT £ / Item	DISC. CODE
16mm	T560791	TUL223/EL Range/CM Range/K3B	0686182002164	-	1	29.67	35.60	IH
20mm	T562521	TUL223/EL Range/CM Range/K3B	0686182002614	-	1	51.80	62.16	
25mm	T562523	TUL223/EL Range/CM Range/K3B	0686182002140	-	1	60.93	73.12	
32mm	T560794	TUL223/EL32	0686182002218	-	1	71.22	85.46	
5/8" od	T591032	TUL223	0686182001471	-	1	25.57	30.68	
5/8" od	T560791	EL Range	0686182002164	-	1	29.67	35.60	
3/4" od	T563409	TUL223	0686182002393	-	1	34.55	41.46	
1" od	T560855	TUL223/CM Range/EL Range/K3B	0686182002041	-	1	60.93	73.12	
1-1/4" od	T560794	TUL223/EL 32	0686182002218	-	1	71.22	85.46	



A DRILL BIT FOR EVERY MATERIAL

	Speed-hammer Plus	Speed-hammer Power	Speed-hammer Max	Masonry	Granite	Cordless MULTI	Glass & Tile	Diamond	HSS Pro	HSS Cobalt	HSS TiN	TCT	Turbomax	Step Drill	Blue Groove 4X/GX	Blue Groove Power	Auger Bits	Brad Point
	Hammer Drill Bits			Rotary Drill Bits					Metal Drill Bits						Wood Drill Bits			
Page	89	87	93	97	98	96	99	99	108	105	107	116	103	115	120	119	123	124
MASONRY																		
Rebar Reinforced Concrete	○	●	●		○													
Concrete	●	●	●	●	●	○												
Natural Stone	●	●	●	●	●	○												
Concrete Blocks	●	●	●	●	●	○												
Aerated Concrete	●	●	●	●	●	●												
Brick	●	●	●	●	●	●												
Hollow Brick	○	○	○	●	●	●	○											
Roof Tile	○	○		○	○	●	○											
Gypsum Board	○	○		●	●	●												
Fiber Cement Board	○	○		●	○	●												
Granite	○	○	○	●	●	○		●										
Marble	○	○	○	○	●	●	○	●										
Slate	○	○		●	●	●	○	●										
Eternit	○	○		●	○	●	●											
Ceramic Tile				○	○	●	●	●										
Hard Density Tile						●		●										
Glass						○	●											
WOOD & BOARD MATERIALS																		
Soft Wood						●			○	○	○	○	●		●	●	●	●
Hard Wood						●			○	○	○	○	●		●	●	●	●
Nail-Embedded Wood									○	○	○	○	○		●			
Chipboard						●			○	○	○	○	●		○	○	○	●
Laminated						●			○	○	○	○	●		○	○	○	●
METAL & PLASTIC																		
Mild Steel									●	○	●	○	●	●				
High-Alloyed Steel									○	●	●	●	○	○				
Sheet Metal						●			●	●	●	○	●	●				
Stainless Steel									○	●	○	○	○	○				
Cast Iron						●			○	●	○	●	○					
Aluminium						●			●	○	●	○	●	●				
Non-Ferrous Metal						●			●	○	●	○	●	●				
Plastics						●			●	○	●		●	●				

● = Especially suitable. Recommended for this material.
○ = Suitable

joran®

The origins of Joran® go back to May 1944 at which time, good friends Poul Jensen and Herman Reinholdt formed the company Jensen and Reinholdt in Hvidovre, Denmark. They initially began producing masonry drill bits and later in 1955 expanded the production line to hammer drill bits.

Both product lines were characterised by uncompromising quality and were mainly offered to the building and construction industry. IRWIN® is committed to continue the original values of these products by delivering state of the art of Power Tool Accessories. The masonry drill bits range is no exception to this, and continues to fulfill the highest industry standards.

The Joran SPEEDHAMMER™ Plus and SPEEDHAMMER™ Power have the certification of “Prüfgemeinschaft Mauerbohrer” e.V. (PGM), which is the official and independent marking validating the standards of masonry drill bits. The mark is granted only to manufacturers fulfilling the following:

- state-of-the-art manufacturing under use of a quality assurance system
- yearly inspections of the produced drill bits by independent institutes

The inspection requirements are developed by the national approval bodies for anchors in co-operation with leading manufacturers of masonry drill bits and anchors. The Steering Committee of PGM® also carries out appropriate investigations in order to assure the suitability of masonry drill bits for anchor fixings.

New types of drills bits get the inspection mark only after extensive testing has been carried out, ensuring the required suitability and performance.



HAMMER DRILL BITS



SPEEDHAMMER® POWER



SPEEDHAMMER® PLUS



SPEEDHAMMER® MAX

ROTARY DRILL BITS



CORDLESS MULTI



MASONRY



GRANITE

SPECIALITY

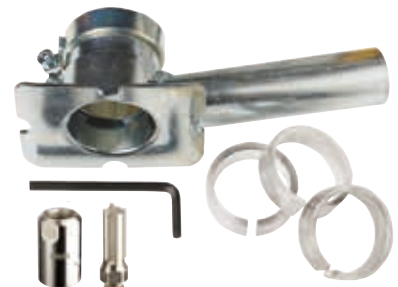

MORTAR RAKES



M-SYSTEM

SPEEDHAMMER™ POWER

LONGEST LASTING IRWIN® HAMMER DRILL BIT EVER!

The new range of Speedhammer™ POWER drill bits is the most powerful yet. The unique tip design with 2X more carbide* is optimised for fast, continuous drilling, even through reinforced concrete, delivering superior performance and 2X longer life*. The Speedhammer™ POWER bit has a high-performance tip that's manufactured with 2X more carbide*.

It easily powers through 2X more concrete and rebar than traditional masonry bits. When long life and durability are crucial, depend on the IRWIN® Speedhammer™ POWER Bit.

2X LONGER LIFE*

SPEEDHAMMER™ POWER

1. **2X MORE CARBIDE IN TIP**
For longer drilling life even in rebar-reinforced concrete.
2. **FAST 2-CUTTING CARBIDE TIP**
Optimised for cutting through rebar at high speed.
3. **MAXIMISED FLUTE**
For faster, more efficient dust and debris removal.
4. **PREMIUM STEEL**
Provides improved core strength for maximum durability and extended life.
5. **BLUE POWER RING**
For easier identification in the toolbox.
6. **OPTIMAL GROOVE DESIGN**
Minimises friction for increased speed and longer life.

**SPEED
POWER
HAMMER™**

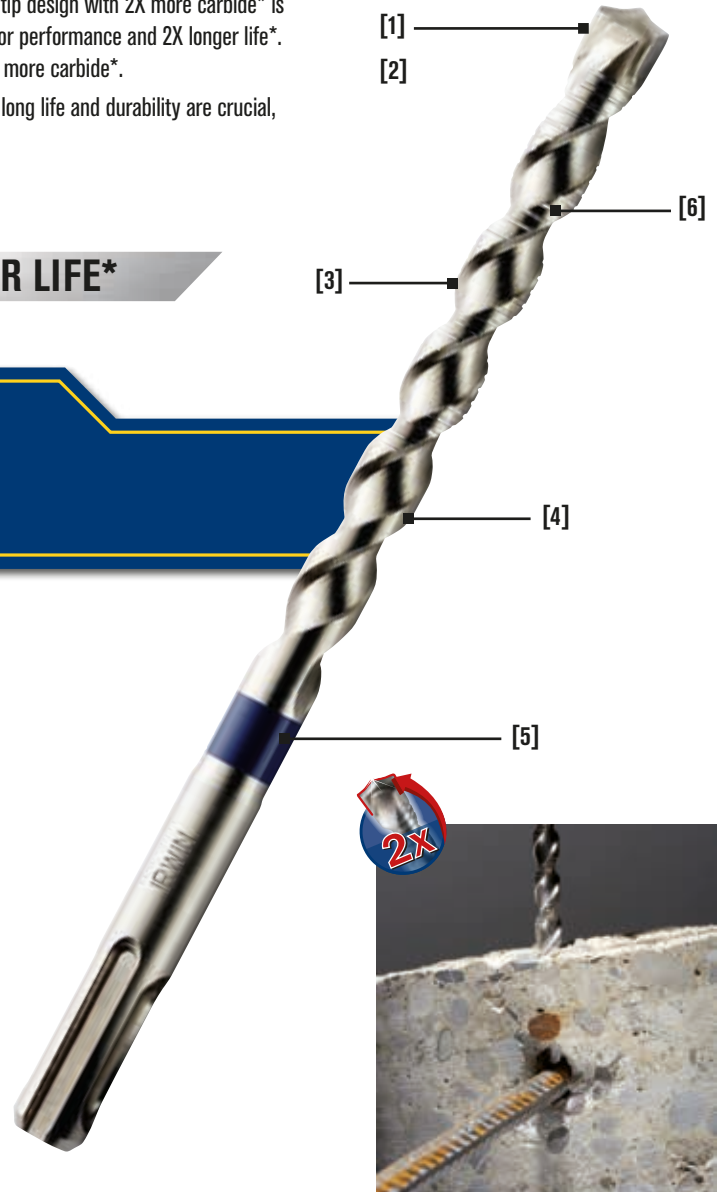

MASONRY DRILLING

APPLICATION:

Compatible with all hammer drilling machines with SDS-plus holder. Optimised for fast, continuous drilling, even through reinforced concrete, delivering superior performance and 2X longer life*.

DRILLING RECOMMENDATION:

When using drill bits with length over 400mm, pre-drill at least 150mm deep with a shorter drill bit of the same diameter.

* vs traditional masonry bits

SPEEDHAMMER™ Power drill bits have the certification of Prüfungsgemeinschaft Mauerbohrer e.V. (PGM).

BENEFITS OF PGM MARKED DRILL BITS:

- Strict tolerance limits for the diameter and the symmetry of the carbide tip ensuring the exactness of the drill hole.
- Secure anchoring and fixing.
- Constant quality assurance.
- Safety and confidence in the product.



Adherence to these criteria is constantly controlled by PGM, making the tool safe and trustworthy for the end user as well as the distributor.



ALSO AVAILABLE IN SETS
SEE PAGE 136

SPEEDHAMMER™ POWER DRILL BITS

Item No.	Diameter mm	Working Length mm	Total Length mm	Piece per Pack	EAN	Master Pack	Shelf Pack	LP Ex VAT £ / Item	RRP Inc VAT £ / Item	DISC. CODE
10507124	5.0	50	110	1	5706915071245	200	10	6.44	7.73	
10507125	5.0	100	160	1	5706915071252	200	10	6.77	8.12	
10507126	6.0	50	110	1	5706915071269	200	10	6.46	7.75	
10507127	6.0	100	160	1	5706915071276	200	10	6.96	8.35	
10507128	6.0	150	210	1	5706915071283	200	10	9.60	11.52	
10507129	6.0	200	260	1	5706915071290	200	10	12.98	15.58	
10507131	6.5	100	160	1	5706915071313	200	10	7.26	8.71	
10507132	6.5	150	210	1	5706915071320	100	10	9.90	11.88	
10507133	6.5	200	260	1	5706915071337	100	10	16.67	20.00	
10507134	7.0	110	160	1	5706915071344	200	10	8.36	10.03	
10507135	7.0	150	210	1	5706915071351	100	10	9.60	11.52	
10507136	8.0	50	110	1	5706915071368	200	10	8.05	9.66	
10507137	8.0	100	160	1	5706915071375	200	10	8.78	10.54	
10507138	8.0	150	210	1	5706915071382	100	10	9.60	11.52	
10507139	8.0	200	260	1	5706915071399	100	10	13.93	16.72	
10507140	8.0	240	300	1	5706915071405	100	10	11.89	14.27	
10507142	10.0	50	110	1	5706915071429	200	10	8.76	10.51	
10507143	10.0	100	160	1	5706915071436	200	10	8.76	10.51	
10507144	10.0	150	210	1	5706915071443	100	10	11.22	13.46	
10507145	10.0	200	260	1	5706915071450	100	10	11.72	14.06	
10507146	10.0	240	300	1	5706915071467	100	10	12.16	14.59	
10507147	10.0	400	460	1	5706915071474	100	1	24.75	29.70	
10507148	12.0	100	160	1	5706915071481	100	10	11.18	13.42	
10507149	12.0	150	210	1	5706915071498	100	10	13.63	16.36	
10507150	12.0	200	260	1	5706915071504	100	10	12.86	15.43	
10507151	12.0	240	300	1	5706915071511	50	10	13.63	16.36	
10507152	12.0	400	460	1	5706915071528	50	1	27.92	33.50	
10507153	14.0	100	160	1	5706915071535	100	10	14.87	17.84	
10507154	14.0	150	210	1	5706915071542	50	10	14.14	16.97	
10507156	14.0	240	300	1	5706915071566	50	10	20.25	24.30	
10507157	14.0	400	460	1	5706915071573	20	1	29.36	35.23	
10507159	16.0	150	210	1	5706915071597	50	1	20.10	24.12	
10507160	16.0	240	300	1	5706915071603	40	1	28.03	33.64	
10507161	16.0	400	460	1	5706915071610	20	1	31.21	37.45	
10507163	18.0	240	300	1	5706915071634	40	1	34.39	41.27	
10507164	18.0	400	460	1	5706915071641	20	1	49.26	59.11	
10507166	20.0	240	300	1	5706915071665	40	1	52.00	62.40	
10507167	20.0	400	460	1	5706915071672	20	1	59.68	71.62	

PTA A

SPEEDHAMMER™ PLUS

FASTEST IRWIN® HAMMER DRILL BIT EVER

Speed. Set the pace with Speedhammer™ Plus. With 28% greater flute capacity, the innovative design goes straight in and straight out. It removes dust and debris really fast. And it's particularly effective in uncured concrete due to clog-free performance.



20% FASTER*



1. INNOVATIVE HEAD AND TIP GEOMETRY

25% thicker carbide tip improves strength and durability. Aggressive concave cutting angles increase drilling speed by up to 20%. Extra short drill bit head clears drilling dust directly into the flute, reducing the risk of clogging. Centering point prevents walking.

2. UNIQUE FLUTE DESIGN

New extra deep, asymmetrical flute design secures a faster dust removal and increases drilling speed.

3. SURFACE TREATMENT

Drill bit fully hardened resulting in maximum rupture strength.

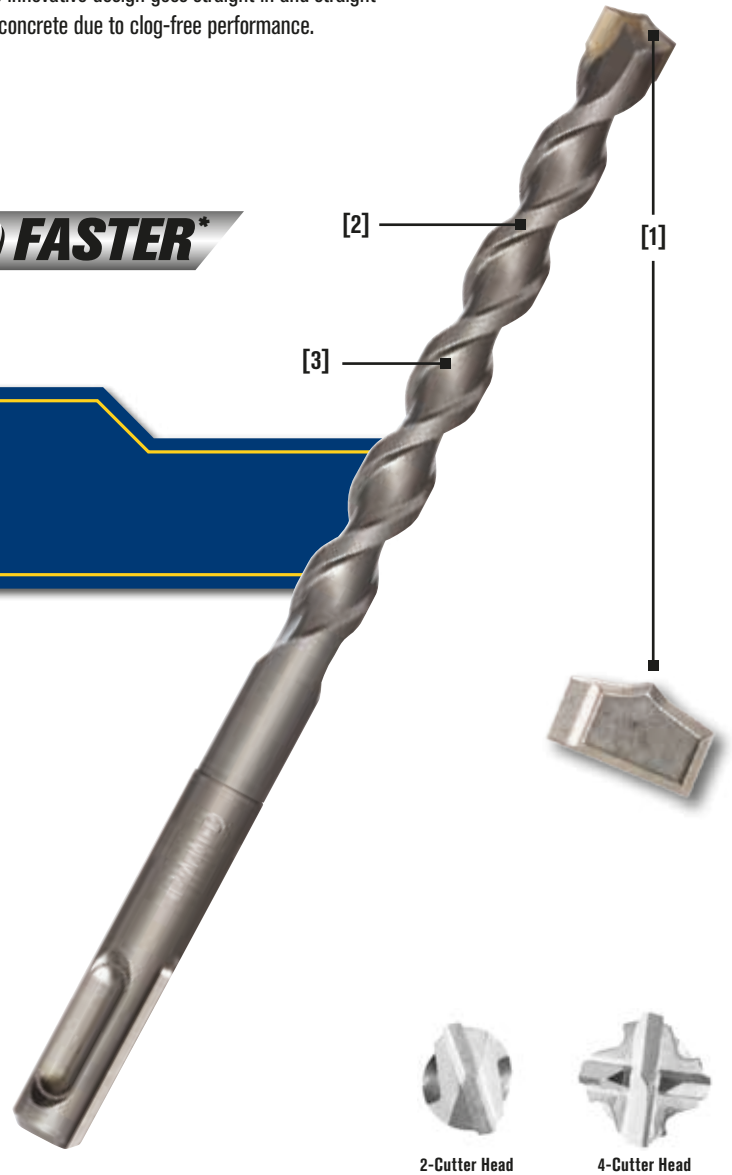

MASONRY DRILLING

APPLICATION:

Compatible with all hammer drilling machines with SDS-plus holder. Designed for drilling in concrete, masonry, brick, block, and granite.

DRILLING RECOMMENDATION:

When using drill bits with length over 400mm, pre-drill at least 150mm deep with a shorter drill bit of the same diameter.

* Up to 20% faster drilling vs. competitor products due to tip geometry and innovative flute design.

SPEEDHAMMER™ Plus drill bits have the certification of Prüfgemeinschaft Mauerbohrer e.V. (PGM).

BENEFITS OF PGM MARKED DRILL BITS:

- Strict tolerance limits for the diameter and the symmetry of the carbide tip ensuring the exactness of the drill hole.
- Secure anchoring and fixing.
- Constant quality assurance.
- Safety and confidence in the product.



Adherence to these criteria is constantly controlled by PGM, making the tool safe and trustworthy for the end user as well as the distributor.



SPEEDHAMMER™ PLUS DRILL BITS

Item No.	Diameter mm	Working Length mm	Total Length mm	Piece per Pack	EAN	Master Pack	Shelf Pack	LP Ex VAT £ / Item	RRP Inc VAT £ / Item	DISC. CODE
10501941	3.0	50	110	1	5709131203599	200	10	3.32	3.98	
10507574	3.0	80	140	1	5706915075748	200	10	7.35	8.82	
10501942	3.5	50	110	1	5709131061656	200	10	3.32	3.98	
10507575	3.5	80	140	1	5706915075755	100	10	7.73	9.28	
10501943	4.0	50	110	1	5709131019282	200	10	3.17	3.80	
10501944	4.0	100	160	1	5709131019350	200	10	3.81	4.57	
10503844	4.5	100	160	1	0734442175582	200	1	3.87	4.64	
10501945	5.0	50	110	1	5709131019466	200	10	3.49	4.19	
10501946	5.0	100	160	1	5709131019800	200	10	3.65	4.38	
10501947	5.0	150	210	1	5709131236962	100	10	4.70	5.64	
10501948	5.0	200	260	1	5709131204237	100	10	4.96	5.95	
10501949	5.5	50	110	1	5709131020011	200	10	3.35	4.02	
10501950	5.5	100	160	1	5709131020233	200	10	3.51	4.21	
10501951	5.5	150	210	1	5709131020363	100	10	5.16	6.19	
10501952	5.5	200	260	1	5709131281030	100	10	6.41	7.69	
10501953	5.5	240	300	1	5709131236986	100	10	6.52	7.82	
10501954	6.0	50	110	1	5709131020400	200	10	3.50	4.20	
10501955	6.0	100	160	1	5709131020769	200	10	3.76	4.51	
10501956	6.0	150	210	1	5709131021070	100	10	5.19	6.23	
10501957	6.0	200	260	1	5709131021124	100	10	11.44	13.73	
10501958	6.0	240	300	1	5709131236948	100	10	12.36	14.83	
10501959	6.0	400	460	1	5709131021162	50	1	16.06	19.27	
10501960	6.5	50	110	1	5709131021186	200	10	3.59	4.31	
10501961	6.5	100	160	1	5709131021353	200	10	3.92	4.70	
10501962	6.5	150	210	1	5709131021537	100	10	5.36	6.43	
10501963	6.5	200	260	1	5709131021544	100	10	9.02	10.82	
10501964	7.0	50	110	1	5709131021582	200	10	4.15	4.98	
10501965	7.0	100	160	1	5709131021704	200	10	4.52	5.42	
10501966	7.0	150	210	1	5709131021919	100	10	5.19	6.23	
10501967	7.0	340	400	1	5709131228929	50	10	17.48	20.98	
10501968	8.0	50	110	1	5709131021971	200	10	4.35	5.22	
10501969	8.0	100	160	1	5709131022305	200	10	4.75	5.70	
10501970	8.0	150	210	1	5709131022701	100	10	5.19	6.23	
10501971	8.0	200	260	1	5709131022947	100	10	6.03	7.24	
10501972	8.0	240	300	1	5709131023029	100	10	6.42	7.70	
10501973	8.0	400	460	1	5709131023142	50	1	14.06	16.87	
10501974	8.0	540	600	1	5709131023227	50	1	22.66	27.19	
10501975	9.0	100	160	1	5709131023364	200	10	5.39	6.47	
10501976	9.0	150	210	1	5709131023449	100	10	6.40	7.68	
10501978	10.0	50	110	1	5709131023524	200	10	4.74	5.69	
10501979	10.0	100	160	1	5709131023722	200	10	4.96	5.95	
10501980	10.0	150	210	1	5709131024095	100	10	6.07	7.28	
10501981	10.0	200	260	1	5709131024378	100	10	6.33	7.60	
10501982	10.0	240	300	1	5709131024484	100	10	6.59	7.91	
10501984	10.0	400	460	1	5709131024620	50	1	13.39	16.07	
10501985	10.0	540	600	1	5709131024750	50	1	19.58	23.50	
10501986	10.0	940	1000	1	5709131135418	20	1	37.88	45.46	
10501987	11.0	100	160	1	5709131024866	100	10	6.31	7.57	
10501988	11.0	200	260	1	5709131025047	50	10	7.36	8.83	
10501989	11.0	240	300	1	5709131025061	50	10	7.33	8.80	
10501991	12.0	100	160	1	5709131025153	100	10	6.05	7.26	
10501992	12.0	150	210	1	5709131025498	100	10	7.36	8.83	
10501993	12.0	170	230	1	5709131025610	100	10	6.88	8.26	
10501994	12.0	200	260	1	5709131025689	100	10	6.97	8.36	
10501995	12.0	240	300	1	5709131025771	50	10	7.36	8.83	
10501996	12.0	400	460	1	5709131025917	50	1	15.10	18.12	
10501997	12.0	540	600	1	5709131026044	20	1	19.96	23.95	
10501998	12.0	740	800	1	5709131026105	20	1	38.65	46.38	
10501999	12.0	940	1000	1	5709131026112	20	1	49.66	59.59	
10502000	13.0	100	160	1	5709131026280	100	10	7.88	9.46	
10502002	13.0	240	300	1	5709131026488	50	10	9.32	11.18	
10502004	14.0	100	160	1	5709131026624	100	1	8.04	9.65	
10502005	14.0	150	210	1	5709131026778	50	1	7.64	9.17	
10502006	14.0	170	230	1	5709131026846	50	1	9.16	10.99	
10502007	14.0	200	260	1	5709131026907	50	1	10.18	12.22	

SPEEDHAMMER™ PLUS DRILL BITS

Item No.	Diameter mm	Working Length mm	Total length mm	Piece per Pack	EAN	Master Pack	Shelf Pack	LP Ex VAT £ / Item	RRP Inc VAT £ / Item	DISC CODE
10502008	14.0	240	300	1	5709131026983	50	1	10.94	13.13	PTA A
10502010	14.0	400	460	1	5709131027058	20	1	15.88	19.06	
10502011	14.0	540	600	1	5709131027188	20	1	24.87	29.84	
10502012	14.0	940	1000	1	5709131137610	20	1	50.18	60.22	
10502013	15.0	100	160	1	5709131027331	100	1	9.58	11.50	
10502014	15.0	170	230	1	5709131027492	50	1	11.59	13.91	
10502015	15.0	200	260	1	5709131027539	50	1	12.03	14.44	
10502016	15.0	240	300	1	5709131027584	40	1	13.37	16.04	
10502017	16.0	100	160	1	5709131027713	100	1	10.53	12.64	
10502018	16.0	150	210	1	5709131027829	50	1	10.87	13.04	
10502019	16.0	170	230	1	5709131027959	50	1	11.03	13.24	
10502020	16.0	240	300	1	5709131028055	40	1	15.15	18.18	
10502021	16.0	400	460	1	5709131028154	20	1	16.88	20.26	
10502022	16.0	540	600	1	5709131028314	20	1	26.03	31.24	
10502023	16.0	740	800	1	5709131028383	20	1	43.05	51.66	
10502024	16.0	940	1000	1	5709131028413	10	1	59.89	71.87	
10502025	17.0	150	210	1	5709131028475	50	1	18.20	21.84	
10502027	18.0	150	210	1	5709131028635	50	1	16.27	19.52	
10502028	18.0	240	300	1	5709131028857	40	1	18.60	22.32	
10502029	18.0	400	460	1	5709131028925	20	1	26.64	31.97	
10502030	18.0	540	600	1	5709131029038	20	1	32.66	39.19	
10502031	18.0	940	1000	1	5709131096290	10	1	74.89	89.87	
10502033	19.0	240	300	1	5709131029205	40	1	21.35	25.62	
10502035	19.0	400	460	1	5709131029267	20	1	32.12	38.54	
10502036	20.0	150	210	1	5709131029373	50	1	21.42	25.70	
10502038	20.0	240	300	1	5709131029595	40	1	28.12	33.74	
10502040	20.0	400	460	1	5709131029670	20	1	32.26	38.71	
10502041	20.0	540	600	1	5709131029823	10	1	44.09	52.91	
10502042	20.0	940	1000	1	5709131097129	10	1	71.53	85.84	
10502043	22.0	200	260	1	5709131029939	25	1	30.43	36.52	
10502044	22.0	240	300	1	5709131030003	40	1	30.43	36.52	
10502046	22.0	400	460	1	5709131030126	10	1	34.29	41.15	
10502047	22.0	540	600	1	5709131030263	10	1	52.25	62.70	
10502048	22.0	940	1000	1	5709131097594	10	1	89.76	107.71	
10502049	24.0	200	260	1	5709131030331	10	1	33.05	39.66	
10502050	24.0	240	300	1	5709131030386	20	1	33.05	39.66	
10502052	24.0	400	460	1	5709131030478	10	1	36.45	43.74	
10502053	25.0	200	260	1	5709131030584	10	1	35.24	42.29	
10502054	25.0	240	300	1	5709131030638	20	1	34.11	40.93	
10502056	25.0	400	460	1	5709131030720	10	1	38.16	45.79	
10502057	25.0	550	600	1	5709131258483	5	1	39.77	47.72	
10502059	26.0	240	300	1	5709131030898	20	1	36.51	43.81	
10502060	26.0	400	460	1	5709131030942	10	1	51.47	61.76	
10502061	26.0	540	600	1	5709131128397	10	1	53.31	63.97	

**SPEED
PLUS
HAMMER™**



**ALSO
AVAILABLE
IN SETS
SEE PAGE 136**

MASONRY DRILLING

SPEEDHAMMER™ PLUS DRILL BITS - 4 CUTTING EDGES

Item No.	Diameter mm	Working Length mm	Total length mm	Piece per Pack	EAN	Master Pack	Shelf Pack	LP Ex VAT £ / Item	RRP Inc VAT £ / Item	DISC CODE
10502069	28.0	400	450	1	5709131184553	5	1	71.54	85.85	PTA A
10502070	30.0	400	450	1	5709131184577	3	1	79.97	95.96	

**SPEED
PLUS
HAMMER™**



SPEEDHAMMER™ PLUS DRILL BITS - BULK PACK

Item No.	Diameter mm	Working Length mm	Total length mm	Piece per Pack	EAN	Master Pack	Shelf Pack	LP Ex VAT £ / Item	RRP Inc VAT £ / Item	DISC. CODE
10503603	5.0	50	110	5	5709131286172	1	1	16.73	20.08	PTA A
10503604	5.5	50	110	5	5709131286295	1	1	15.93	19.12	
10503605	6.0	50	110	5	5709131286202	1	1	17.87	21.44	
10503606	6.0	100	160	5	5709131285991	1	1	18.05	21.66	
10503607	6.0	150	210	5	5709131286028	1	1	24.91	29.89	
10503608	6.5	150	210	5	5709131286059	1	1	25.71	30.85	
10503609	8.0	50	110	5	5709131280231	1	1	20.87	25.04	
10503610	8.0	100	160	5	5709131286110	1	1	22.55	27.06	
10503611	8.0	150	210	5	5709131286080	1	1	24.91	29.89	
10503612	10.0	100	160	5	5709131286141	1	1	23.58	28.30	
10503613	10.0	150	210	5	5709131286325	1	1	29.11	34.93	
10502071	5.0	50	110	10	5709131176206	30	1	32.07	38.48	
10502072	5.0	100	160	10	5709131176220	30	1	32.84	39.41	
10502073	5.5	50	110	10	5709131176244	30	1	30.86	37.03	
10502074	5.5	100	160	10	5709131176268	30	1	32.91	39.49	
10502075	6.0	50	110	10	5709131176282	1	1	32.17	38.60	
10502076	6.0	100	160	10	5709131176305	30	1	33.85	40.62	
10502077	6.0	150	210	10	5709131228943	20	1	47.75	57.30	
10502080	6.5	150	210	10	5709131230823	20	1	49.25	59.10	
10503845	7.0	100	160	10	0734442175827	30	1	40.67	48.80	
10502082	8.0	100	160	10	5709131176404	30	1	42.81	51.37	
10502083	8.0	150	210	10	5709131176428	20	1	47.75	57.30	
10502084	10.0	50	110	10	5709131176442	30	1	43.63	52.36	
10502085	10.0	100	160	10	5709131253341	25	1	44.69	53.63	
10502086	10.0	150	210	10	5709131176480	25	1	55.80	66.96	
10502087	12.0	100	160	10	5709131176503	25	1	54.43	65.32	
10502088	12.0	150	210	10	5709131230199	20	1	67.76	81.31	

SPEEDHAMMER™ MAX

DESIGNED FOR TOUGHER TASKS!



SPEEDHAMMER™ MAX DRILL BITS 2 CUTTING EDGES

Item No.	Diameter mm	Working Length mm	Total length mm	Piece per Pack	EAN	Master Pack	Shelf Pack	LP Ex VAT £ / Item	RRP Inc VAT £ / Item	DISC CODE
10502092	12.0	200	340	1	5709131233756	25	1	33.59	40.31	PTA B
10502093	12.0	400	540	1	5709131233770	10	1	41.49	49.79	
10502094	12.0	550	690	1	5709131233794	10	1	56.28	67.54	
10502095	14.0	200	340	1	5709131233817	25	1	42.38	50.86	
10502096	14.0	400	540	1	5709131233831	10	1	47.88	57.46	
10502097	15.0	200	340	1	5709131233855	25	1	46.83	56.20	
10502098	15.0	400	540	1	5709131233879	10	1	52.38	62.86	

SPEEDHAMMER™ MAX DRILL BITS 4 CUTTING EDGES

Item No.	Diameter mm	Working Length mm	Total length mm	Piece per Pack	EAN	Master Pack	Shelf Pack	LP Ex VAT £ / Item	RRP Inc VAT £ / Item	DISC CODE
10502099	16.0	200	340	1	5709131233893	25	1	48.94	58.73	PTA B
10502100	16.0	400	540	1	5709131233916	10	1	52.22	62.66	
10502101	18.0	200	340	1	5709131233930	25	1	48.85	58.62	
10502102	18.0	400	540	1	5709131233954	10	1	54.52	65.42	
10502103	20.0	200	320	1	5709131233978	25	1	57.75	69.30	
10502104	20.0	400	520	1	5709131233992	10	1	59.93	71.92	
10502105	20.0	800	920	1	5709131234012	5	1	85.99	103.19	
10502106	22.0	200	320	1	5709131234036	25	1	57.75	69.30	
10502107	22.0	400	520	1	5709131234050	10	1	59.93	71.92	
10502108	22.0	800	920	1	5709131234074	5	1	103.50	124.20	
10502109	24.0	200	320	1	5709131234098	10	1	64.62	77.54	
10502110	24.0	400	520	1	5709131234111	5	1	66.15	79.38	
10502111	25.0	200	320	1	5709131234135	10	1	61.99	74.39	
10502112	25.0	400	520	1	5709131234159	5	1	66.15	79.38	
10502113	25.0	800	920	1	5709131234173	5	1	143.77	172.52	
10502115	28.0	250	370	1	5709131234197	5	1	69.06	82.87	
10502116	28.0	450	570	1	5709131234210	5	1	78.04	93.65	
10502117	28.0	550	670	1	5709131234234	5	1	140.11	168.13	
10502118	30.0	250	370	1	5709131234241	3	1	80.82	96.98	
10502119	30.0	450	570	1	5709131234272	3	1	84.81	101.77	
10502120	32.0	250	370	1	5709131234296	3	1	76.54	91.85	
10502121	32.0	450	570	1	5709131234319	3	1	84.21	101.05	
10502122	32.0	800	920	1	5709131234333	3	1	155.64	186.77	
10502123	35.0	250	370	1	5709131234340	3	1	82.28	98.74	
10502124	35.0	450	570	1	5709131234364	3	1	94.78	113.74	
10502125	35.0	550	670	1	5709131234388	2	1	122.06	146.47	
10502126	38.0	250	370	1	5709131234395	2	1	98.42	118.10	
10502127	38.0	450	570	1	5709131234401	2	1	127.02	152.42	
10502128	40.0	250	370	1	5709131234418	2	1	109.06	130.87	
10502129	40.0	430	570	1	5709131234425	2	1	146.63	175.96	
10502130	40.0	780	920	1	5709131234647	2	1	213.64	256.37	

IRWIN® tip design enhances dust removal and provides symmetrical holes
Head takes 80% of the workload, ensuring higher durability, speed and rebar performance
53° drilling head design means more aggressive cutting and faster dust removal for overall faster performance
Four-cutter tips for less vibration, faster drilling, rounder holes and better anchoring
Single Flute design for faster dust removal and increased drilling speed
Shank fits in all SDS Max Hammer Machines



MASONRY DRILLING

For a wide range of applications for both SDS Plus and SDS Max hammer drills: breaking through, breaking up concrete, light demolition work and chasing of channels for pipes and electrical conduit

Application: concrete and masonry
Grey sandblasted professional finish

DEMOLITION CHISELS

POINTED CHISEL



For general chiselling and breaking work in brick, concrete and loose stone (eg: when laying cables)

FLAT CHISEL



For general chiselling and breaking work in brick, concrete and loose stone (eg: when laying cables)

SPADE CHISEL



For removing large quantities of material

GOUGE CHISEL



For cutting narrow channels into concrete

TCT POINTING CHISEL



For the removal of pointing in brickwork

CRANKED TILE CHISEL



For easy removal of tiles

ALSO AVAILABLE IN SETS SEE PAGE 136

SPEEDHAMMER™ PLUS DEMOLITION CHISELS

Item No.	Description	EAN	Master Pack	Shelf Pack	LP Ex VAT £ / Item	RRP Inc VAT £ / Item	DISC. CODE
10502194	Pointed Chisel 250mm	5709131281979	-	1	7.87	9.44	PTA B
10502195	Flat Chisel 20 x 250mm	5709131281986	-	1	7.90	9.48	
10502196	Spade Chisel 40 x 250mm	5709131281993	-	1	12.04	14.45	
10502197	Gouge Chisel 22 x 250mm	5709131282006	-	1	15.71	18.85	
10502198	TCT Pointing Chisel 32 x 125mm	5709131285595	-	1	87.92	105.50	
10502200	TCT Pointing Chisel 32 x 200mm	5709131285601	-	1	68.61	82.33	
10503643	Cranked Tile Chisel 40 x 250mm	5706915001273	-	1	14.29	17.15	

SPEEDHAMMER™ MAX DEMOLITION CHISELS

Item No.	Description	EAN	Master Pack	Shelf Pack	LP Ex VAT £ / Item	RRP Inc VAT £ / Item	DISC. CODE
10502184	Pointed Chisel 280mm	5709131281870	-	1	7.06	8.47	PTA B
10502185	Pointed Chisel 400mm	5709131281887	-	1	8.50	10.20	
10502186	Pointed Chisel 600mm	5709131281894	-	1	16.50	19.80	
10502187	Flat Chisel 25 x 280mm	5709131281900	-	1	7.06	8.47	
10502188	Flat Chisel 25 x 400mm	5709131281917	-	1	8.50	10.20	
10502189	Flat Chisel 25 x 600mm	5709131281924	-	1	16.63	19.96	
10502190	Spade Chisel 115 x 350mm	5709131281931	-	1	15.44	18.53	
10502191	Spade Chisel 50 x 400mm	5709131281948	-	1	21.95	26.34	
10502192	Spade Chisel 80 x 300mm	5709131281955	-	1	19.64	23.57	
10502193	Gouge Chisel 26 x 300mm	5709131281962	-	1	24.31	29.17	
10503644	Cranked Tile Chisel 50 x 400mm	5706915001297	-	1	28.57	34.28	



HEAVY DUTY CORE DRILLS

Designed for drilling large diameter holes in concrete and rock.



Designed for drilling of large diameters (35-150mm) into: Concrete, Granite and other very hard materials



Item No.	Description	Hole Dia	Length	Piece per Pack	EAN	Master Pack	Shelf Pack	LP Ex VAT £ / Item	RRP Inc VAT £ / Item	DISC CODE
10507198	Drill Rod 180mm SPDHMAX	-	180	1	5706915071986	50	1	45.57	54.68	PTA B
10507199	Drill Rod 450mm SPDHMAX	-	450	1	5706915071993	20	1	65.82	78.98	
10507200	Drill Rod 115mm SPDHPLUS	-	115	1	5706915072006	80	1	43.04	51.65	
10507211	HD Core Drill 40mm	40	100	1	5706915072112	20	1	82.29	98.75	
10507213	HD Core Drill 50mm	50	100	1	5706915072136	20	1	92.41	110.89	
10507214	HD Core Drill 60mm	60	100	1	5706915072143	15	1	97.48	116.98	
10507215	HD Core Drill 65mm	65	100	1	5706915072150	15	1	102.53	123.04	
10507216	HD Core Drill 75mm	75	100	1	5706915072167	8	1	113.94	136.73	
10507217	HD Core Drill 80mm	80	100	1	5706915072174	8	1	126.60	151.92	
10507218	HD Core Drill 90mm	90	100	1	5706915072181	6	1	151.91	182.29	
10507219	HD Core Drill 100mm	100	100	1	5706915072198	6	1	164.57	197.48	
10507220	HD Core Drill 115mm	115	100	1	5706915072204	4	1	227.87	273.44	
10507221	HD Core Drill 125mm	125	100	1	5706915072211	4	1	240.52	288.62	
10507222	HD Core Drill 150mm	150	100	1	5706915072228	3	1	300.02	360.02	
10507224	Pilot Drill Bit 11 x 120mm	11	120	1	5706915072242	200	1	7.85	9.42	
10507225	Core Drill Drift Key	-	-	1	5706915072259	200	1	7.85	9.42	

Pilot drill: To easily remove the pilot drill from the drill rod, push the drift key into the slot of the drill rod

LIGHTWEIGHT CORE DRILLS



Designed for fast and easy drilling of larger diameters (30-80mm) into: Masonry, Brick, Natural stone, Autoclaved aerated concrete and Drywall/gypsum board



Item No.	Description	Hole Dia	Length	Piece per Pack	EAN	Master Pack	Shelf Pack	LP Ex VAT £ / Item	RRP Inc VAT £ / Item	DISC CODE
10507203	LW Core Drill 30mm	30	58	1	5706915072037	50	1	48.11	57.73	PTA B
10507204	LW Core Drill 35mm	35	58	1	5706915072044	50	1	50.63	60.76	
10507205	LW Core Drill 40mm	40	58	1	5706915072051	45	1	53.17	63.80	
10507206	LW Core Drill 45mm	45	58	1	5706915072068	25	1	55.70	66.84	
10507207	LW Core Drill 50mm	50	58	1	5706915072075	25	1	56.96	68.35	
10507208	LW Core Drill 65mm	65	50	1	5706915072082	20	1	64.56	77.47	
10507209	LW Core Drill 80mm	80	50	1	5706915072099	9	1	69.63	83.56	
10507201	Drill Rod 105mm SPDHPLUS	-	105	1	5706915072013	60	1	32.91	39.49	
10507223	Pilot Drill Bit 8 x 120mm	-	120	1	5706915072235	200	1	7.49	8.99	

Pilot drill: The pilot drill is securely fixed by a set screw which can be tightened with a hex key
Core removal: After drilling, the core often gets stuck in the core drill. To make the removal easier, the lightweight core drills have a hole

CORDLESS MULTI

ONE DRILL BIT FOR EVERY NEED!

The Cordless Multi drill bit is IRWIN®'s most versatile drill bit. It is designed to drill in multiple materials including brick, light concrete, dry wall, ceramic tiles, sheet metal, wood, plastic and marble. In addition to the multipurpose function, the Cordless Multi is IRWIN®'s problem solver for drilling into ceramic tiles up to a hardness grade of 9.

CORDLESS MULTI

1. HARDEST CARBIDE GRADE

And unique point grinding for fast drilling into most common materials and hardest tiles (scratch hardness 9).

2. SINGLE FLUTE DESIGN

Giving maximum space for dust removal. Up to 15% Speed advantage over competition. 10% more holes per battery charge.

3. UNIQUE TIP GRINDING

Brazed carbide tip has a unique diamond ground 4-face design for excellent centering and perfect hole quality.

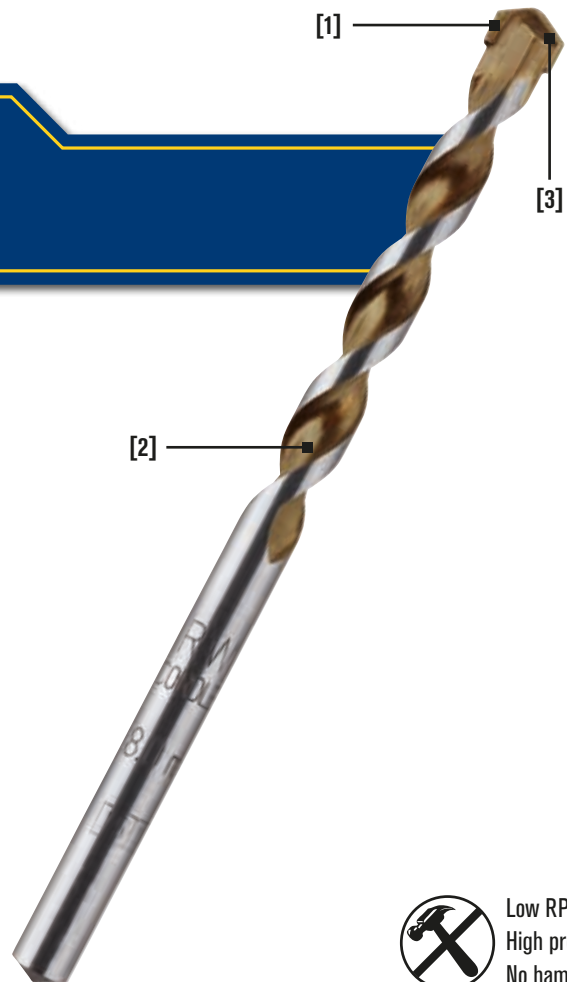

Low RPM.
High pressure.
No hammer action.



CORDLESS MULTI DRILL BITS - ROTARY DRILLING ONLY

Item No.	Diameter mm	Working Length mm	Total length mm	Shank Diameter mm	EAN	Master Pack	Shelf Pack	LP Ex VAT £ / Item	RRP Inc VAT £ / Item	DISC. CODE
10501919	3.0	40	70	CYL as Ø	5709131285731	200	10	3.38	4.06	
10501920	3.5	40	75	CYL as Ø	5709131285762	200	10	3.55	4.26	
10501921	4.0	45	80	CYL as Ø	5709131000303	200	10	3.31	3.97	
10501922	5.0	50	90	CYL as Ø	5709131000563	200	10	3.55	4.26	
10501923	5.5	55	95	CYL as Ø	5709131000822	200	10	3.88	4.66	
10501924	5.5	115	160	CYL as Ø	5709131055037	200	10	5.15	6.18	
10501925	6.0	60	100	CYL as Ø	5709131000983	200	10	4.06	4.87	
10501926	6.0	115	160	CYL as Ø	5709131001164	200	10	5.34	6.41	
10501927	6.0	120	200	CYL as Ø	5709131247593	100	10	5.86	7.03	
10501928	6.5	60	100	CYL as Ø	5709131001348	200	10	4.39	5.27	
10501929	6.5	120	200	CYL as Ø	5709131243007	100	10	6.15	7.38	
10501930	7.0	65	100	CYL as Ø	5709131001577	200	10	4.60	5.52	
10501931	7.0	115	160	CYL as Ø	5709131001720	200	10	5.95	7.14	
10501932	8.0	70	120	CYL as Ø	5709131001836	200	10	4.88	5.86	
10501933	8.0	120	200	CYL as Ø	5709131002086	100	10	6.64	7.97	
10501934	10.0	70	120	CYL as Ø	5709131002710	200	10	5.89	7.07	
10501935	10.0	120	200	CYL as Ø	5709131002918	100	10	7.87	9.44	
10501936	12.0	105	160	CYL as Ø	5709131003267	50	10	7.52	9.02	
10501937	14.0	100	160	10	5709131003717	50	10	9.38	11.26	

ALSO AVAILABLE IN SETS
SEE PAGE 137

PTA A

MASONRY

FASTEST AND LONGEST LASTING MASONRY DRILL BIT ON THE MARKET



MASONRY



MASONRY DRILL BITS - ROTARY PERCUSSION

Item No.	Diameter mm	Working Length mm	Total length mm	Shank Diameter mm	EAN	Master Pack	Shelf Pack	LP Ex VAT £ / Item	RRP Inc VAT £ / Item	DISC CODE
10501812	3.0	40	70	CYL as Ø	5709131000129	200	10	1.91	2.29	PTA A
10501813	3.5	45	75	CYL as Ø	5709131000211	200	10	1.91	2.29	
10501814	4.0	45	80	CYL as Ø	5709131055839	200	10	1.91	2.29	
10501815	4.0	115	160	CYL as Ø	5709131055075	200	10	2.32	2.78	
10501816	4.5	45	85	CYL as Ø	5709131000488	200	10	1.88	2.26	
10501817	5.0	50	90	CYL as Ø	5709131055846	200	10	1.88	2.26	
10501818	5.0	115	160	CYL as Ø	5709131000778	200	10	2.48	2.98	
10501819	5.5	55	95	CYL as Ø	5709131055853	200	10	2.00	2.40	
10501820	5.5	115	160	CYL as Ø	5709131000952	200	10	2.72	3.26	
10501821	6.0	60	100	CYL as Ø	5709131055860	200	10	2.22	2.66	
10501822	6.0	115	160	CYL as Ø	5709131055877	200	10	3.02	3.62	
10501823	6.0	280	330	CYL as Ø	5709131001225	100	1	6.88	8.26	
10501824	6.0	300	400	CYL as Ø	5709131001249	50	1	8.87	10.64	
10501825	6.0	500	600	CYL as Ø	5709131001287	50	1	10.73	12.88	
10501826	6.5	60	100	CYL as Ø	5709131055884	200	10	2.22	2.66	
10501827	6.5	115	160	CYL as Ø	5709131001461	200	10	3.08	3.70	
10501829	6.5	300	400	CYL as Ø	5709131001546	50	1	8.98	10.78	
10503846	6.5	500	600	CYL as Ø	5706915038460	50	1	10.59	12.71	
10501830	7.0	60	100	CYL as Ø	5709131055891	200	10	2.32	2.78	
10501831	7.0	115	160	CYL as Ø	5709131055907	200	10	3.32	3.98	
10501834	8.0	70	120	CYL as Ø	5709131055914	200	10	2.69	3.23	
10501835	8.0	110	160	CYL as Ø	5709131002055	200	10	3.43	4.12	
10501836	8.0	130	200	CYL as Ø	5709131055921	100	10	4.45	5.34	
10501837	8.0	280	330	CYL as Ø	5709131002130	100	1	7.75	9.30	
10501838	8.0	300	400	CYL as Ø	5709131002147	50	1	9.43	11.32	
10501839	8.0	500	600	CYL as Ø	5709131002215	50	1	12.24	14.69	
10501841	9.0	70	120	CYL as Ø	5709131002352	200	10	3.17	3.80	
10501846	10.0	70	120	CYL as Ø	5709131055938	200	10	4.01	4.81	
10501847	10.0	110	160	CYL as Ø	5709131002871	200	10	4.52	5.42	
10501848	10.0	130	200	CYL as Ø	5709131055945	100	10	6.07	7.28	
10501849	10.0	280	330	CYL as Ø	5709131002963	100	1	8.16	9.79	
10501850	10.0	300	400	CYL as Ø	5709131002987	50	1	11.29	13.55	
10501851	10.0	500	600	CYL as Ø	5709131003007	50	1	15.52	18.62	
10501853	11.0	105	160	CYL as Ø	5709131003106	50	10	4.45	5.34	
10501854	12.0	105	160	CYL as Ø	5709131055952	50	10	5.31	6.37	
10501855	12.0	280	330	CYL as Ø	5709131003397	30	1	10.73	12.88	
10501856	12.0	300	400	CYL as Ø	5709131003403	30	1	13.21	15.85	
10501857	12.0	500	600	CYL as Ø	5709131003434	30	1	16.29	19.55	
10501859	13.0	100	160	10	5709131003526	50	10	5.99	7.19	
10501861	13.0	300	400	10	5709131003663	30	1	13.28	15.94	
10501862	14.0	100	160	10	5709131055969	50	10	7.64	9.17	
10501863	14.0	280	330	10	5709131003762	30	1	12.62	15.14	
10501864	14.0	300	400	10	5709131003786	30	1	15.32	18.38	
10501865	14.0	500	600	10	5709131003809	30	1	20.40	24.48	
10501866	15.0	85	160	10	5709131003878	50	1	8.59	10.31	
10501867	16.0	85	160	10	5709131003915	50	1	9.86	11.83	
10501868	16.0	280	330	10	5709131003977	15	1	12.35	14.82	
10501869	16.0	300	400	10	5709131003991	15	1	16.29	19.55	
10501870	16.0	500	600	13	5709131004035	15	1	22.73	27.28	
10501873	18.0	80	160	13	5709131004158	50	1	13.77	16.52	
10501874	18.0	300	400	13	5709131004172	15	1	17.43	20.92	
10501875	18.0	500	600	13	5709131004196	15	1	23.90	28.68	
10501878	20.0	80	160	13	5709131004325	50	1	18.73	22.48	
10501879	20.0	280	330	13	5709131004349	10	1	19.09	22.91	
10501880	20.0	300	400	13	5709131004356	10	1	20.98	25.18	
10501881	20.0	500	600	13	5709131004370	10	1	26.01	31.21	
10501882	22.0	80	160	13	5709131004424	50	1	17.97	21.56	
10501884	22.0	300	400	13	5709131004486	10	1	23.26	27.91	
10501885	24.0	80	160	13	5709131004530	25	1	22.68	27.22	
10501886	24.0	300	400	13	5709131004554	5	1	23.26	27.91	

Improved carbide tip design ensures for durable and fast drilling in all masonry materials

Aggressive head design up to 15% Speed advantage over competition

Now 20% more life vs. previous version

Single flute design giving maximum space for dust removal and provides a 60% faster dust removal



MASONRY DRILLING



GRANITE



For percussion drilling in very hard materials such as granite

Extremely hard and wear resistant carbide tip guarantees up to 40% more holes compared to conventional masonry drill bits

Stone masons favour this product for impact drilling of natural stone like granite

Special shaped cutting edges mean higher durability resulting in 50% more accurately sized holes per drill bit.



GRANITE

DESIGNED FOR PERCUSSION DRILLING IN VERY HARD MATERIALS



GRANITE DRILL BITS - ROTARY PERCUSSION

Item No.	Diameter mm	Working Length mm	Total length mm	Shank Diameter mm	EAN	Master Pack	Shelf Pack	LP Ex VAT £ / Item	RRP Inc VAT £ / Item	DISC. CODE
10501894	3.0	40	70	CYL as Ø	5709131008095	200	10	3.25	3.90	PTA A
10501895	3.5	40	75	CYL as Ø	5709131008101	200	10	3.31	3.97	
10501896	4.0	45	80	CYL as Ø	5709131008118	200	10	3.31	3.97	
10501897	5.0	50	90	CYL as Ø	5709131008163	200	10	3.55	4.26	
10501898	5.0	115	160	CYL as Ø	5709131008187	200	10	5.14	6.17	
10501899	5.5	55	95	CYL as Ø	5709131008200	200	10	3.88	4.66	
10501900	5.5	115	160	CYL as Ø	5709131008224	200	10	5.15	6.18	
10501901	6.0	60	100	CYL as Ø	5709131008231	200	10	4.06	4.87	
10501902	6.0	115	160	CYL as Ø	5709131008255	200	10	5.34	6.41	
10501903	6.5	60	100	CYL as Ø	5709131008293	200	10	4.39	5.27	
10501904	6.5	115	160	CYL as Ø	5709131008316	200	10	5.85	7.02	
10501905	7.0	60	100	CYL as Ø	5709131008323	200	10	4.60	5.52	
10501906	7.0	115	160	CYL as Ø	5709131008347	200	10	5.95	7.14	
10501907	8.0	70	120	CYL as Ø	5709131008378	200	10	4.88	5.86	
10501908	8.0	130	200	CYL as Ø	5709131008392	100	10	6.64	7.97	
10501910	9.0	70	120	CYL as Ø	5709131008446	200	10	5.60	6.72	
10501911	10.0	70	120	CYL as Ø	5709131008460	200	10	5.89	7.07	
10501912	10.0	130	200	CYL as Ø	5709131008491	100	10	7.87	9.44	
10501913	11.0	105	160	CYL as Ø	5709131008545	50	10	7.71	9.25	
10501914	12.0	105	160	CYL as Ø	5709131008552	50	10	7.52	9.02	
10501915	13.0	100	160	10	5709131008606	50	10	8.17	9.80	
10501916	14.0	100	160	10	5709131008613	50	10	9.38	11.26	

ALSO AVAILABLE IN SETS
SEE PAGE 137

GLASS AND TILE

FOR DRILLING GLASS, PORCELAIN AND CERAMICS



GLASS & TILES

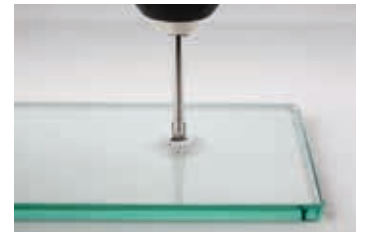

GLASS AND TILE DRILL BITS

Item No.	Description	EAN	Master Pack	Shelf Pack	LP Ex VAT £ / Item	RRP Inc VAT £ / Item	DISC CODE
10507902	Glass & Tile 3mm	5706915079029	200	10	2.94	3.53	PTA B
10507903	Glass & Tile 4mm	5706915079036	200	10	3.05	3.66	
10507904	Glass & Tile 5mm	5706915079043	200	10	3.18	3.82	
10507905	Glass & Tile 6mm	5706915079050	200	10	3.35	4.02	
10507906	Glass & Tile 7mm	5706915079067	200	10	3.63	4.36	
10507907	Glass & Tile 8mm	5706915079074	200	10	3.84	4.61	
10507908	Glass & Tile 9mm	5706915079081	200	10	4.27	5.12	
10507909	Glass & Tile 10mm	5706915079098	200	10	5.03	6.04	
10507910	Glass & Tile 12mm	5706915079104	200	10	5.68	6.82	
10507911	Glass & Tile 13mm	5706915079111	200	10	5.87	7.04	



USEFUL TIPS:

1. Drill with low RPM
2. Water cooling recommended
3. No hammer action



DIAMOND

FOR FAST, SMOOTH CUTTING IN ALL GRADES OF HARD AND SOFT TILES



DIAMOND

MASONRY DRILLING

DIAMOND DRILL BITS

Item No.	Description	EAN	Master Pack	Shelf Pack	LP Ex VAT £ / Item	RRP Inc VAT £ / Item	DISC CODE
10507892	Diamond Drill BIT 5mm	5706915078923	60	1	21.38	25.66	PTA B
10507893	Diamond Drill BIT 6mm	5706915078930	60	1	22.53	27.04	
10507894	Diamond Drill BIT 7mm	5706915078947	60	1	23.33	28.00	
10507895	Diamond Drill BIT 8mm	5706915078954	60	1	23.93	28.72	
10507896	Diamond Drill BIT 10mm	5706915078961	60	1	24.51	29.41	
10507897	Diamond Drill BIT 12mm	5706915078978	60	1	28.68	34.42	
10507898	Diamond Drill BIT 14mm	5706915078985	60	1	31.31	37.57	
10507899	Diamond Drill BIT 15mm	5706915078992	60	1	32.45	38.94	



USEFUL TIPS:

1. Drilling with water increases the lifespan of the tool.
2. Do not press strongly on the tool, let it work.
3. Make a swinging movement to allow dust evacuation.
4. Cutting speed: 2700 RPM.
5. No hammer action.



The drill needs to run before hitting the surface. To avoid sliding of the drill, start with an angle of 45°



Once the hole has started, raise the drill gradually up to the vertical line



Make an oscillating movement while drilling

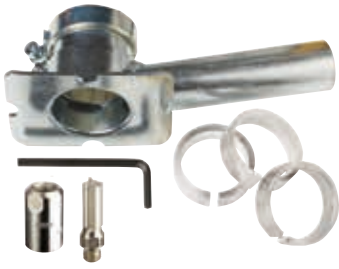

MORTAR RAKES

The Mortar Rake is designed to replace traditional methods of mortar removal such as powered mortar chisels and cutting discs. The rake is faster and less intrusive to surrounding brickwork and, unlike other methods, it is just as efficient for both horizontal and vertical joint clearing.

Please note that the cutters must be used together with an adaptor (10507234) and angle grinder.

Item No.	Description	EAN	Master Pack	Shelf Pack	LP Ex VAT £ / Item	RRP Inc VAT £ / Item	DISC. CODE
10507229	8,0 x 20/40mm, 3 cutter, (2 pcs.)	5706915072297	50	5	10.65	12.78	PTA B
10507230	10,0 x 20/40mm, 3 cutter (2 pcs.)	5706915072303	50	5	10.65	12.78	
10507231	12,0 x 20/40mm, 3 cutter, (2 pcs.)	5706915072310	50	5	11.41	13.69	
10507232	8,0 x 20/40mm, 4 cutter, (2 pcs.)	5706915072327	50	5	12.01	14.41	
10507233	10,0 x 20/40mm, 4 cutter (2 pcs.)	5706915072334	50	5	12.01	14.41	
10507234	Adapter	5706915072341	50	5	5.49	6.59	
10502880	Sole plate U500	5709131266488	15	1	47.67	57.20	
10507267	Starter kit 8mm 1 pc. sole plate, 2 pcs. 8,0mm 3 cutter - 1 pc. adapter	5706915072679	15	1	56.34	67.61	
10507268	Starter kit 10mm 1 pc. sole plate 2 pcs. 10mm 3 cutter - 1 pc. adapter	5706915072686	15	1	56.34	67.61	

M-SYSTEM

M-SYSTEM



2 in 1 tool designed for easy and fast fixing of roofing materials

The M-System is a two-in-one tool for drilling and fixing of fibre cement and similar roofing/panelling materials

Improved carbide tip ensures easy start

After drilling the hole pull back the pilot drill and fix a hexagon screw with the same tool

Item No.	Description	EAN	Master Pack	Shelf Pack	LP Ex VAT £ / Item	RRP Inc VAT £ / Item	DISC. CODE
10507590	M-System 8 mm	5706915075908	30	5	37.86	45.43	PTA B
10502865	M-System 11 mm	5709131054276	15	1	37.86	45.43	
10503476	8 mm Drill Bit for M-System	5709131054290	200	10	2.93	3.52	
10507937	11 mm Drill Bit for M-System	5706915079371	200	10	2.93	3.52	



ENGINEERED FOR CONTROLLED PRECISION AND SPEED

The IRWIN® line of metal drill bits offers of solution for every professional application. Each metal drill bit is made of high speed steel with high precision-cut point and spiral, ensuring durability and quality.

Total Length: The length from the point to the end of the drill bit

Point Angle: The angle of the cutting edges

Drill Diameter: The cutting diameter of the drill bit

Shank Length: The end of the drill bit that is secured by the drill

Working Length: The length from the point to the end of the flutes

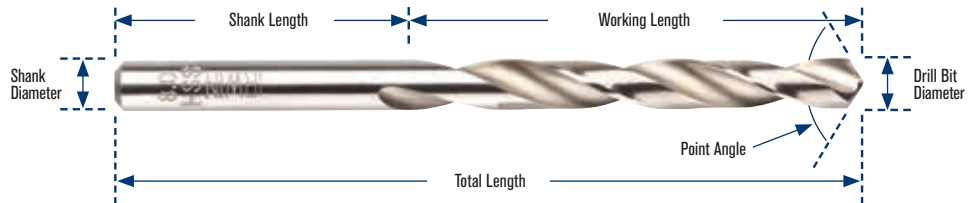

TIP GEOMETRY

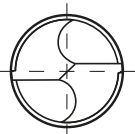

118°



118° STANDARD POINT

- For drilling in alloyed and non-alloyed steels, non-ferrous metals, cast iron and hard plastics
- Can be easily resharpened
- Requires higher feed pressure
- Best for stationary drills

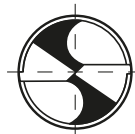

118°



118° SPLIT POINT

- For drilling in alloyed and non-alloyed steels, non-ferrous metals, cast iron and hard plastics
- Very good centering
- Requires less effort / feed pressure

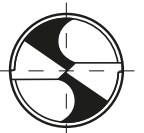

135°



135° SPLIT POINT

- For drilling in high strength steel and high-alloy steels
- Very good centering
- Requires less effort / feed pressure

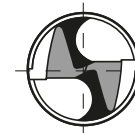

TURBOMAX® JET POINT

- Specially designed for portable drills
- Excellent centering, will not walk on any surface
- Precision-ground to stay sharp longer and drill faster

HSS DRILL BITS



HSS TURBOMAX



HSS TITANIUM



HSS COBALT



HSS PRO

SPECIALITY DRILL BITS



STEP DRILLS



TCT

TURBOMAX™ HSS

DESIGNED FOR HIGH PERFORMANCE DRILLING

Turbomax™ is designed primarily for high performance drilling in sheet metal, however, also performs well in all types of wood and plastic. Suitable for drilling stainless steel however, HSS Cobalt products (p.105) are designed specifically for this purpose. Remember to always use a coolant when drilling stainless steel.



TURBOMAX™

1. 100° TIP FOR FASTEST START

Most precise centering and guidance.
No walking, also on curved surfaces.
No centre punch necessary.

2. 140° CUTTING SHOULDER FOR SMOOTH FINISH

Perfectly round holes.
Clean exit holes – minimised burrs.
Will not bind in multiple layers of thin material.

3. GROUND FLUTE

Ground from solid.

4. REINFORCED WEB

For added strength and durability
Robust design –no breakage.

5. W9 HSS (HIGH SPEED STEEL)

Superb heat resistance.
Sharp cutting lips.

6. HARDENING

Superb wear resistance.
Hardness of 63-66 HRC.

7. 3-FLATTED SHANK

Prevents slipping in chuck.
No damaging of the drill due to slipping.
Safe and strong clamping, especially when using keyless chucks.
Best power supply to the cutting lips – spend the power where it's needed.



JET POINT – REVOLUTIONARY TIP DESIGN
Self centering, will not walk on any surfaces



METAL DRILLING

TURBO MAX



TURBOMAX™ HSS DRILL BITS

Item No.	Diameter mm	Working Length mm	Total length mm	Pcs per Pack	EAN	Master Pack	Shelf Pack	LP Ex VAT £ / Item	RRP Inc VAT £ / Item	DISC. CODE
10502202	1.0	12	34	2	5709131232889	50	10	2.80	3.36	PTA B
10502203	1.5	18	40	2	5709131232902	50	10	2.80	3.36	
10502204	2.0	24	49	2	5709131232926	50	10	2.80	3.36	
10502205	2.5	30	57	2	5709131232940	50	10	2.87	3.44	
10502206	3.0	33	61	1	5709131232964	50	10	1.90	2.28	
10502207	3.1	36	65	1	5709131232988	50	10	1.99	2.39	
10502208	3.2	36	65	1	5709131233008	50	10	2.08	2.50	
10502209	3.3	36	65	1	5709131233046	50	10	2.08	2.50	
10502210	3.5	39	70	1	5709131233060	50	10	2.18	2.62	
10502211	4.0	43	75	1	5709131233084	50	10	2.32	2.78	
10502212	4.1	43	75	1	5709131233107	50	10	2.33	2.80	
10502213	4.2	43	75	1	5709131233121	50	10	2.35	2.82	
10502214	4.3	47	75	1	5709131233541	50	10	2.41	2.89	
10502215	4.5	47	80	1	5709131233145	50	10	2.43	2.92	
10502216	4.8	52	86	1	5709131233169	50	10	2.68	3.22	
10502217	4.9	52	86	1	5709131233183	50	10	2.68	3.22	
10502218	5.0	52	86	1	5709131233206	50	10	2.68	3.22	
10502219	5.1	52	86	1	5709131233220	50	10	2.79	3.35	
10502220	5.5	57	93	1	5709131233244	50	10	2.94	3.53	
10502221	6.0	57	93	1	5709131233268	50	10	2.82	3.38	
10502222	6.5	63	101	1	5709131233282	50	10	3.25	3.90	
10502223	7.0	69	109	1	5709131233305	50	10	3.73	4.48	
10502224	7.5	69	109	1	5709131233329	50	10	4.23	5.08	
10502225	8.0	75	117	1	5709131233367	50	10	4.35	5.22	
10502226	8.5	75	117	1	5709131233381	50	10	5.11	6.13	
10502227	9.0	81	125	1	5709131233404	50	10	5.69	6.83	
10502228	9.5	81	125	1	5709131233428	50	10	6.29	7.55	
10502229	10.0	87	133	1	5709131233442	50	10	6.90	8.28	
10502230	11.0	94	142	1	5709131233466	30	10	8.21	9.85	
10502231	12.0	101	151	1	5709131233480	30	10	10.05	12.06	
10502232	13.0	101	151	1	5709131233503	30	10	10.39	12.47	

**ALSO
AVAILABLE
IN SETS
SEE PAGE 138**

HSS COBALT

DESIGNED FOR DRILLING STAINLESS STEEL



HSS COBALT DRILL BITS - DIN 338

Item No.	Diameter mm	Working Length mm	Total length mm	Pcs per Pack	EAN	Master Pack	Shelf Pack	LP Ex VAT £ / Item	RRP Inc VAT £ / Item	DISC. CODE
10502507	1.0	12	34	2	5709131282532	200	10	1.79	2.15	PTA A
10502508	1.5	18	40	2	5709131282570	200	10	1.79	2.15	
10502509	2.0	24	49	2	5709131282617	200	10	1.85	2.22	
10502510	2.5	30	57	2	5709131282655	200	10	1.89	2.27	
10502542	3.0	33	61	1	5709131282693	200	10	1.89	2.27	
10502543	3.1	36	65	1	5709131282730	200	10	1.91	2.29	
10502544	3.2	36	65	1	5709131282778	200	10	1.91	2.29	
10502545	3.3	36	65	1	5709131282815	200	10	1.91	2.29	
10502546	3.5	39	70	1	5709131282853	200	10	2.15	2.58	
10502547	4.0	43	75	1	5709131282891	200	10	2.39	2.87	
10502549	4.2	43	75	1	5709131282976	200	10	2.77	3.32	
10502551	4.5	47	80	1	5709131283058	200	10	2.77	3.32	
10502552	4.8	52	86	1	5709131283096	200	10	3.21	3.85	
10502554	5.0	52	86	1	5709131283171	200	10	3.21	3.85	
10502556	5.5	57	93	1	5709131283256	200	10	3.89	4.67	
10502557	6.0	57	93	1	5709131283294	200	10	4.20	5.04	
10502558	6.5	63	101	1	5709131283331	100	10	4.86	5.83	
10502559	7.0	69	109	1	5709131283379	100	10	5.57	6.68	
10502560	7.5	69	109	1	5709131283416	100	10	5.57	6.68	
10502561	8.0	75	117	1	5709131283454	100	10	6.99	8.39	
10502563	9.0	81	125	1	5709131283539	100	10	8.35	10.02	
10502565	10.0	87	133	1	5709131283614	100	10	9.94	11.93	
10502566	11.0	94	142	1	5709131283652	50	10	13.83	16.60	
10502567	12.0	101	151	1	5709131283690	50	10	16.61	19.93	
10502568	13.0	101	151	1	5709131283737	50	10	21.69	26.03	

135° SPLIT POINT GRINDING ensures perfect centering and reduced drilling pressure
GROUND FLUTE Industrial quality ground flute for high accuracy drilling and fast removal of chips
COBALT ALLOYED Drill bit body manufactured from high quality HSS steel containing 5% Cobalt (Co). The added 5% Cobalt improves the red hardness (heat resistance) of the drill bit and results in significantly extended life
SURFACE FINISH Golden tempered surface



HSS COBALT DRILL BITS - DIN 338 - BULK PACK

Item No.	Diameter mm	Working Length mm	Total length mm	Pcs per Pack	EAN	Master Pack	Shelf Pack	LP Ex VAT £ / Item	RRP Inc VAT £ / Item	DISC. CODE
10502511	1.0	12	34	10	5706915000450	50	1	17.01	20.41	PTA A
10502512	1.5	18	40	10	5706915000474	50	1	17.01	20.41	
10502513	2.0	24	49	10	5706915000498	50	1	17.58	21.09	
10502514	2.5	30	57	10	5706915000511	50	1	17.96	21.55	
10502515	3.0	33	61	10	5706915000535	50	1	17.96	21.55	
10502519	3.5	39	70	10	5706915000610	50	1	20.43	24.51	
10502520	4.0	43	75	10	5706915000634	50	1	22.71	27.25	
10502524	4.5	47	80	10	5706915000719	50	1	26.32	31.58	
10502527	5.0	52	86	10	5706915000771	50	1	30.50	36.59	
10502529	5.5	57	93	10	5706915000818	20	1	36.96	44.35	
10502530	6.0	57	93	10	5706915000832	50	1	39.90	47.88	
10502532	7.0	69	109	10	5706915000894	20	1	52.92	63.50	
10502533	7.5	69	109	5	5706915000870	40	1	26.46	31.75	
10502534	8.0	75	117	5	5706915000917	40	1	33.20	39.84	
10502536	9.0	81	125	5	5706915000955	40	1	39.66	47.60	
10502537	9.5	81	125	5	5706915000979	40	1	47.22	56.66	
10502538	10.0	87	133	5	5706915000993	40	1	47.22	56.66	
10502539	11.0	94	142	5	5706915001013	20	1	65.69	78.83	
10502540	12.0	101	151	5	5706915001037	20	1	78.90	94.68	
10502541	13.0	101	151	5	5706915001051	20	1	103.03	123.63	



METAL DRILLING

ALSO AVAILABLE IN SETS SEE PAGE 139



HSS TITANIUM FAST AND PRECISE



HSS TITANIUM DRILL BITS - DIN 338

Item No.	Diameter mm	Working Length mm	Total length mm	Pcs per Pack	EAN	Master Pack	Shelf Pack	LP Ex VAT £ / Item	RRP Inc VAT £ / Item	DISC. CODE
10502572	1.0	12	34	2	5709131282556	200	10	0.90	1.08	PTA A
10502573	1.5	18	40	2	5709131282594	200	10	0.90	1.08	
10502574	2.0	24	49	2	5709131282631	200	10	1.05	1.26	
10502575	2.5	30	57	2	5709131282679	200	10	1.14	1.37	
10502576	3.0	33	61	1	5709131282716	200	10	1.14	1.37	
10502577	3.1	36	65	1	5709131282754	200	10	1.21	1.45	
10502578	3.2	36	65	1	5709131282792	200	10	1.21	1.45	
10502579	3.3	36	65	1	5709131282839	200	10	1.21	1.45	
10502580	3.5	39	70	1	5709131282877	200	10	1.21	1.45	
10502581	4.0	43	75	1	5709131282914	200	10	1.39	1.67	
10502582	4.1	43	75	1	5709131282952	200	10	1.46	1.75	
10502583	4.2	43	75	1	5709131282990	200	10	1.46	1.75	
10502584	4.3	47	80	1	5709131283034	200	10	1.46	1.75	
10502585	4.5	47	80	1	5709131283072	200	10	1.46	1.75	
10502586	4.8	52	86	1	5709131283119	200	10	1.58	1.90	
10502587	4.9	52	86	1	5709131283157	200	10	1.58	1.90	
10502588	5.0	52	86	1	5709131283195	200	10	1.58	1.90	
10502589	5.1	52	86	1	5709131283232	200	10	1.71	2.05	
10502590	5.5	57	93	1	5709131283270	200	10	1.71	2.05	
10502591	6.0	57	93	1	5709131283317	200	10	1.83	2.20	
10502592	6.5	63	101	1	5709131283355	100	10	2.05	2.46	
10502593	7.0	69	109	1	5709131283393	100	10	2.27	2.72	
10502594	7.5	69	109	1	5709131283430	100	10	2.50	3.00	
10502595	8.0	75	117	1	5709131283478	100	10	3.06	3.67	
10502596	8.5	75	117	1	5709131283515	100	10	3.22	3.86	
10502597	9.0	81	125	1	5709131283553	100	10	3.52	4.22	
10502598	9.5	81	125	1	5709131283591	100	10	3.76	4.51	
10502599	10.0	87	133	1	5709131283638	100	10	4.21	5.05	
10502600	11.0	94	142	1	5709131283676	50	10	4.73	5.68	
10502601	12.0	101	151	1	5709131283713	50	10	5.47	6.56	
10502602	13.0	101	151	1	5709131283751	50	10	6.06	7.27	

135° SPLIT POINT GRINDING ensures perfect centering and reduced drilling pressure

GROUND FLUTE Industrial quality ground flute for high accuracy drilling and fast removal of chips

TITANIUM NITRIDE COATED Drill bit body manufactured from high quality HSS steel coated with Titanium Nitride (TiN).

The TiN coating has a hardness of app. 80 HRC and is very resistant to wear.

TiN has a low coefficient of friction. This results in less power being consumed and less heat generated during the drilling.

SPEED AND FEED Compared to traditional HSS Twist Drill Bits speed can be increased by 40 -60% and feed by 10 -20% without reducing the life time of the drill bit significantly

LESS HEAT TiN is also a poor conductor of heat, so the heat generated during the drilling process is diverted into the chips and coolant and less into the drill bit



ALSO AVAILABLE IN SETS
SEE PAGE 139



HSS PRO

TOUGHNESS AND PRECISION FOR PROFESSIONAL USERS

The new HSS PRO is an Industrial quality twist drill with outstanding performance and long service life. It is designed for drilling steel and steel castings, alloyed and non-alloyed steel, cast iron, non-ferrous metals, plastics and other materials.

The 118° split point shape provides an optimum centering when starting and a faster drilling rate. It requires lower feed pressure than standard HSS drill bits with a chisel edge.

HSS PRO

1. 118° SPLIT POINT SHAPE

- With increased performance and very good centering
- Precision starting, no need to pre-punch or pilot drill.
- Penetrates quickly.
- Requires less effort / feed pressure.

2. GREATEST TOUGHNESS

And low risk of breakage even when drilling with smaller diameters due to high elasticity.

3. OPTIMUM DRILLING PERFORMANCE

Even in unfavourable working conditions.

4. HIGHLY ACCURATE

Close tolerances and high concentricity for maximum precision.

5. HIGHEST STEEL GRADE

High-performance, High-Speed Steel.



40% MORE HOLES*
*vs previous version

HSS PRO DRILL RANGE

The HSS PRO drill bits are available in a wide range of variety: DIN 338 jobber series, DIN 340 long series, double-ended stub series, DIN 345 Morse taper shank series.

DIN 338		DIN 338 series, suitable for many trade and industrial applications in alloyed and un-alloyed steel, non-ferrous metals, cast iron and plastics.
DIN 340		DIN 340 long series, most suitable for drilling deep holes or through hollow profiles.
DOUBLE-ENDED		Double ended series, especially designed for drilling thin materials like sheet metal, flat steel and profiles. Ideal for use with hand-held drills.
DIN 345		DIN 345 Morse taper shank series, strong standard drills for use with stationary drilling machines. High breaking resistance.

HSS PRO

DESIGNED FOR DRILLING A WIDE SELECTION OF MATERIALS



HSS PRO DRILL BITS - DIN 338

Item No.	Diameter mm	Working Length mm	Total length mm	Pcs per Pack	EAN	Master Pack	Shelf Pack	LP Ex VAT £ / Item	RRP Inc VAT £ / Item	DISC CODE
10502376	1.0	12	34	3	5709131104674	200	10	1.83	2.20	PTA B
10502377	1.5	18	40	3	5709131104865	200	10	1.83	2.20	
10502378	2.0	24	49	3	5709131105084	200	10	2.12	2.54	
10502379	2.5	30	57	3	5709131105251	200	10	2.16	2.59	
10502380	3.0	33	61	3	5709131105466	200	10	2.32	2.78	
10502381	3.2	36	65	2	5709131105589	200	10	1.78	2.14	
10502382	3.3	36	65	2	5709131105657	200	10	1.78	2.14	
10502383	3.5	39	70	2	5709131105732	200	10	1.84	2.21	
10502384	4.0	43	75	2	5709131105930	200	10	2.09	2.51	
1863343	4.1	43	75	2	5706918633433	200	10	2.14	2.57	
10502385	4.2	43	75	2	5709131106050	200	10	2.14	2.57	
10502386	4.5	47	80	2	5709131106166	200	10	2.31	2.77	
1863344	4.8	52	86	2	5706918633440	200	10	2.49	2.99	
10502387	5.0	52	86	2	5709131106371	200	10	2.49	2.99	
1863345	5.1	52	86	1	5706918633457	200	10	1.49	1.79	
1863346	5.2	52	86	1	5706918633464	200	10	1.49	1.79	
10502388	5.5	57	93	1	5709131106555	200	10	1.68	2.02	
10502389	6.0	57	93	1	5709131106753	200	10	1.79	2.15	
10502390	6.5	63	101	1	5709131106944	100	10	2.11	2.53	
10502391	7.0	69	109	1	5709131107101	100	10	2.27	2.72	
10502392	7.5	69	109	1	5709131107279	100	10	2.60	3.12	
10502393	8.0	75	117	1	5709131107477	100	10	2.93	3.52	
10502394	8.5	75	117	1	5709131107668	100	10	3.06	3.67	
10502395	9.0	81	125	1	5709131107842	100	10	3.44	4.13	
10502396	9.5	81	125	1	5709131108016	100	10	3.80	4.56	
10502397	10.0	87	133	1	5709131108207	100	10	3.97	4.76	

118° SPLIT POINT SHAPE for increased performance and very good centering
MANUFACTURED to DIN 338 Standards
SURFACE FINISH: Polished silver
PACKAGED in skin card up to Ø 13 mm, in Quadro Pack from Ø 13.5 mm and above



ALSO AVAILABLE IN SETS
SEE PAGE 140

METAL DRILLING

HSS PRO DRILL BITS - REDUCED SHANK - DIN 338



Item No.	Diameter mm	Working Length mm	Total length mm	Shank Diameter mm	EAN	Master Pack	Shelf Pack	LP Ex VAT £ / Item	RRP Inc VAT £ / Item	DISC CODE
10502398	10.5	87	133	10mm	5709131108429	50	10	6.22	7.46	PTA B
10502399	11.0	94	142	10mm	5709131108597	50	10	7.09	8.51	
10502400	11.5	94	142	10mm	5709131108764	50	10	7.27	8.72	
10502401	12.0	101	151	10mm	5709131108948	50	10	7.74	9.29	
10502402	12.5	101	151	10mm	5709131109099	50	10	7.91	9.49	
10502403	13.0	101	151	10mm	5709131109266	50	10	8.21	9.85	
10502404	13.5	108	160	10mm	5709131109402	50	10	10.20	12.24	
10502405	14.0	108	160	10mm	5709131109471	50	10	11.03	13.24	
10502406	14.5	114	169	10mm	5709131109570	25	5	12.37	14.84	
10502407	15.0	114	169	10mm	5709131109662	25	5	13.01	15.61	
10502408	15.5	120	178	10mm	5709131109730	25	5	15.31	18.37	
10502409	16.0	120	178	10mm	5709131109822	25	5	15.94	19.13	
10502410	16.5	125	184	13mm	5709131109921	25	5	18.28	21.94	
10502411	17.0	125	184	13mm	5709131109990	25	5	19.04	22.85	
10502412	17.5	130	191	13mm	5709131110064	25	5	20.39	24.47	
10502413	18.0	130	191	13mm	5709131110132	25	5	21.07	25.28	
10502414	18.5	135	198	13mm	5709131110200	25	5	22.93	27.52	
10502415	19.0	135	198	13mm	5709131110286	25	5	25.37	30.44	
10502416	19.5	140	205	13mm	5709131110354	25	5	27.60	33.12	
10502417	20.0	140	205	13mm	5709131110439	25	5	28.72	34.46	



HSS PRO DRILL BITS - DIN 338 - BULK PACK

Item No.	Diameter mm	Working Length mm	Total length mm	Pcs per Pack	EAN	Master Pack	Shelf Pack	LP Ex VAT £ / Item	RRP Inc VAT £ / Item	DISC. CODE
10502236	0.5	6	22	10	5709131035923	50	1	5.10	6.12	
10502237	0.6	7	24	10	5709131035954	50	1	5.10	6.12	
10502238	0.7	9	28	10	5709131035978	50	1	5.10	6.12	
10502239	0.8	10	30	10	5709131035992	50	1	5.10	6.12	
10502240	0.9	11	32	10	5709131036012	50	1	5.10	6.12	
10502241	1.0	12	34	10	5709131036043	50	1	5.62	6.74	
10502242	1.1	14	36	10	5709131036098	50	1	5.62	6.74	
10502243	1.2	16	38	10	5709131036128	50	1	5.62	6.74	
10502244	1.3	16	38	10	5709131036159	50	1	5.62	6.74	
10502245	1.4	18	40	10	5709131036180	50	1	5.62	6.74	
10502246	1.5	18	40	10	5709131036210	50	1	5.62	6.74	
10502247	1.6	20	43	10	5709131036272	50	1	5.95	7.14	
10502248	1.7	20	43	10	5709131036302	50	1	5.95	7.14	
10502249	1.8	22	46	10	5709131036326	50	1	5.95	7.14	
10502250	1.9	22	46	10	5709131036357	50	1	5.95	7.14	
10502251	2.0	24	49	10	5709131036401	50	1	6.28	7.54	
10502252	2.1	24	49	10	5709131036463	50	1	6.62	7.94	
10502253	2.2	27	53	10	5709131036487	50	1	6.62	7.94	
10502254	2.3	27	53	10	5709131036517	50	1	6.62	7.94	
10502255	2.4	30	57	10	5709131036548	50	1	6.62	7.94	
10502256	2.5	30	57	10	5709131036562	50	1	6.62	7.94	
10502257	2.6	30	57	10	5709131036623	50	1	6.93	8.32	
10502258	2.7	33	61	10	5709131036654	50	1	6.93	8.32	
10502259	2.8	33	61	10	5709131036685	50	1	7.28	8.74	
10502260	2.9	33	61	10	5709131036708	50	1	7.28	8.74	
10502261	3.0	33	61	10	5709131036746	50	1	7.09	8.51	
10502262	3.1	36	65	10	5709131036814	50	1	7.28	8.74	
10502263	3.2	36	65	10	5709131036852	50	1	7.28	8.74	
10502264	3.3	36	65	10	5709131036906	50	1	7.28	8.74	
10502265	3.4	39	70	10	5709131036944	50	1	8.26	9.91	
10502266	3.5	39	70	10	5709131036968	50	1	8.26	9.91	
10502267	3.6	39	70	10	5709131037033	50	1	8.78	10.54	
10502268	3.7	39	70	10	5709131037057	50	1	8.78	10.54	
10502269	3.8	43	75	10	5709131037071	50	1	9.09	10.91	
10502270	3.9	43	75	10	5709131037095	50	1	9.09	10.91	
10502271	4.0	43	75	10	5709131231202	50	1	9.09	10.91	
10502272	4.1	43	75	10	5709131037200	50	1	10.09	12.11	
10502273	4.2	43	75	10	5709131037231	50	1	10.09	12.11	
10502274	4.3	47	80	10	5709131037262	50	1	10.09	12.11	
10502275	4.4	47	80	10	5709131037293	50	1	10.42	12.50	
10502276	4.5	47	80	10	5709131037316	50	1	10.42	12.50	
10502277	4.6	47	80	10	5709131037378	50	1	10.42	12.50	
10502278	4.7	47	80	10	5709131037392	50	1	11.72	14.06	
10502279	4.8	52	86	10	5709131037439	50	1	11.72	14.06	
10502280	4.9	52	86	10	5709131037460	50	1	11.72	14.06	
10502281	5.0	52	86	10	5709131037491	50	1	11.72	14.06	
10502282	5.1	52	86	10	5709131037569	50	1	12.88	15.46	
10502283	5.2	52	86	10	5709131037606	50	1	12.88	15.46	
10502284	5.3	52	86	10	5709131037620	50	1	13.55	16.26	
10502285	5.4	57	93	10	5709131037644	50	1	13.55	16.26	
10502286	5.5	57	93	10	5709131037668	50	1	14.72	17.66	
10502287	5.6	57	93	10	5709131037729	50	1	15.71	18.85	
10502288	5.7	57	93	10	5709131037743	50	1	15.71	18.85	
10502289	5.8	57	93	10	5709131037774	50	1	15.71	18.85	
10502290	5.9	57	93	10	5709131037798	50	1	15.97	19.16	
10502291	6.0	57	93	10	5709131037835	50	1	16.03	19.24	
10502292	6.1	63	101	10	5709131037903	20	1	17.69	21.23	
10502293	6.2	63	101	10	5709131037934	20	1	17.69	21.23	
10502294	6.3	63	101	10	5709131037958	20	1	17.69	21.23	
10502295	6.4	63	101	10	5709131037989	20	1	18.67	22.40	
10502296	6.5	63	101	10	5709131038016	20	1	18.67	22.40	
10502297	6.6	63	101	10	5709131038061	20	1	19.35	23.22	
10502299	6.8	69	109	10	5709131038115	20	1	20.51	24.61	
10502300	6.9	69	109	10	5709131038139	20	1	20.51	24.61	
10502301	7.0	69	109	10	5709131038153	20	1	20.51	24.61	
10502302	7.1	69	109	5	5709131038207	40	1	11.18	13.42	
10502303	7.2	69	109	5	5709131038238	40	1	11.33	13.60	

HSS PRO DRILL BITS - DIN 338 - BULK PACK

Item No.	Diameter mm	Working Length mm	Total length mm	Pcs per Pack	EAN	Master Pack	Shelf Pack	LP Ex VAT £ / Item	RRP Inc VAT £ / Item	DISC CODE
10502304	7.3	69	109	5	5709131038269	40	1	11.79	14.15	
10502305	7.4	69	109	5	5709131038283	40	1	11.79	14.15	
10502306	7.5	69	109	5	5709131038306	40	1	11.79	14.15	
10502307	7.6	75	117	5	5709131038368	40	1	12.07	14.48	
10502308	7.7	75	117	5	5709131038382	40	1	12.07	14.48	
10502309	7.8	75	117	5	5709131038405	40	1	12.67	15.20	
10502310	7.9	75	117	5	5709131038429	40	1	12.67	15.20	
10502311	8.0	75	117	5	5709131038474	40	1	13.20	15.84	
10502312	8.1	75	117	5	5709131038559	40	1	13.20	15.84	
10502313	8.2	75	117	5	5709131038580	40	1	13.89	16.67	
10502314	8.3	75	117	5	5709131038603	40	1	13.89	16.67	
10502315	8.4	75	117	5	5709131038634	40	1	15.78	18.94	
10502316	8.5	75	117	5	5709131038658	40	1	14.06	16.87	
10502317	8.6	81	125	5	5709131038702	40	1	15.64	18.77	
10502318	8.7	81	125	5	5709131038733	40	1	15.64	18.77	
10502319	8.8	81	125	5	5709131038764	40	1	15.64	18.77	
10502320	8.9	81	125	5	5709131038788	40	1	15.64	18.77	
10502321	9.0	81	125	5	5709131038818	40	1	16.22	19.46	
10502322	9.1	81	125	5	5709131038863	40	1	16.22	19.46	
10502323	9.2	81	125	5	5709131038894	40	1	16.22	19.46	
10502324	9.3	81	125	5	5709131038917	40	1	16.54	19.85	
10502325	9.4	81	125	5	5709131038931	40	1	16.54	19.85	
10502326	9.5	81	125	5	5709131038962	40	1	17.87	21.44	
10502327	9.6	87	133	5	5709131039020	40	1	18.52	22.22	
10502328	9.7	87	133	5	5709131039051	40	1	18.52	22.22	
10502329	9.8	87	133	5	5709131039075	40	1	18.52	22.22	
10502330	9.9	87	133	5	5709131039099	40	1	18.52	22.22	
10502331	10.0	87	133	5	5709131039129	40	1	18.52	22.22	
10502332	10.1	87	133	5	5709131184638	20	1	21.91	26.29	
10502333	10.2	87	133	5	5709131039211	20	1	21.91	26.29	
10502334	10.3	87	133	5	5709131039242	20	1	21.91	26.29	
10502335	10.4	87	133	5	5709131039273	20	1	21.91	26.29	
10502336	10.5	87	133	5	5709131039297	20	1	22.24	26.69	
10502337	10.6	87	133	5	5709131039365	20	1	23.34	28.01	
10502338	10.7	94	142	5	5709131039389	20	1	23.34	28.01	
10502339	10.8	94	142	5	5709131163114	20	1	23.34	28.01	
10502340	10.9	94	142	5	5709131039419	20	1	23.34	28.01	
10502341	11.0	94	142	5	5709131039433	20	1	24.46	29.35	
10502342	11.1	94	142	5	5709131039501	20	1	26.69	32.03	
10502343	11.2	94	142	5	5709131039525	20	1	26.69	32.03	
10502344	11.3	94	142	5	5709131039549	20	1	26.69	32.03	
10502345	11.4	94	142	5	5709131039563	20	1	26.69	32.03	
10502346	11.5	94	142	5	5709131039587	20	1	26.69	32.03	
10502348	11.7	94	142	5	5709131039679	20	1	29.52	35.42	
10502349	11.8	94	142	5	5709131039686	20	1	29.52	35.42	
10502350	11.9	101	151	5	5709131039709	20	1	29.52	35.42	
10502351	12.0	101	151	5	5709131039723	20	1	29.52	35.42	
10502352	12.1	101	151	5	5709131039792	20	1	29.52	35.42	
10502353	12.2	101	151	5	5709131039822	20	1	29.52	35.42	
10502355	12.4	101	151	5	5709131039853	20	1	29.52	35.42	
10502356	12.5	101	151	5	5709131039877	20	1	30.91	37.09	
10502357	12.6	101	151	5	5709131039921	20	1	32.33	38.80	
10502358	12.7	101	151	5	5709131039945	20	1	32.33	38.80	
10502360	12.9	101	151	5	5709131039990	20	1	32.33	38.80	
10502361	13.0	101	151	5	5709131040002	20	1	32.33	38.80	
10502362	13.5	108	160	5	5709131281085	20	1	37.39	44.87	
10502363	14.0	108	160	1	5709131040163	25	1	12.04	14.45	
10502364	14.5	114	169	1	5709131040200	25	1	14.22	17.06	
10502365	15.0	114	169	1	5709131040262	25	1	16.52	19.82	

PTA B





HSS PRO DRILL BITS - DIN 338 - BULK PACK

Item No.	Diameter mm	Working Length mm	Total length mm	Pcs per Pack	EAN	Master Pack	Shelf Pack	LP Ex VAT £ / Item	RRP Inc VAT £ / Item	DISC. CODE
10502366	15.5	120	178	1	5709131040316	25	1	17.42	20.90	PTA B
10502367	16.0	120	178	1	5709131040354	25	1	18.47	22.16	
10502368	16.5	125	184	1	5709131040408	25	1	19.33	23.20	
10502369	17.0	125	184	1	5709131040460	25	1	20.02	24.02	
10502370	17.5	130	191	1	5709131040507	25	1	21.13	25.36	
10502371	18.0	130	191	1	5709131040545	25	1	22.79	27.35	
10502372	18.5	135	198	1	5709131040583	25	1	24.06	28.87	
10502373	19.0	135	198	1	5709131040620	25	1	25.15	30.18	
10502374	19.5	140	205	1	5709131040675	25	1	26.55	31.86	
10502375	20.0	140	205	1	5709131040712	25	1	27.51	33.01	

HSS PRO LONG DRILL BITS - DIN 340



118° SPLIT POINT SHAPE for increased performance and very good centering
MANUFACTURED to DIN 340 Standards
SURFACE FINISH: Polished silver
PACKAGED in skin card

Item No.	Diameter mm	Working Length mm	Total length mm	Pcs per Pack	EAN	Master Pack	Shelf Pack	LP Ex VAT £ / Item	RRP Inc VAT £ / Item	DISC. CODE
1863347	3.0	66	100	1	5706918633471	200	10	2.11	2.53	PTA B
1863348	4.0	78	119	1	5706918633488	200	10	2.48	2.98	
1863349	5.0	87	132	1	5706918633495	200	10	3.11	3.73	
1863350	6.0	91	139	1	5706918633501	200	10	3.70	4.44	
1863361	8.0	109	165	1	5706918633617	100	10	6.15	7.38	
1863362	10.0	121	184	1	5706918633624	100	10	7.50	9.00	

HSS PRO LONG DRILL BITS - DIN 340 - BULK PACK

Item No.	Diameter mm	Working Length mm	Total length mm	Pcs per Pack	EAN	Master Pack	Shelf Pack	LP Ex VAT £ / Item	RRP Inc VAT £ / Item	DISC. CODE
10502482	2.0	56	85	10	5709131061755	20	1	26.14	31.37	PTA B
10502483	2.5	62	95	10	5709131041931	20	1	24.33	29.20	
10502484	3.0	66	100	10	5709131041948	20	1	24.33	29.20	
10503855	3.2	69	106	10	5706915938555	20	1	24.27	29.12	
10502485	3.5	73	112	10	5709131041955	20	1	29.11	34.93	
10502486	4.0	78	119	10	5709131041962	20	1	32.09	38.51	
10503856	4.2	78	119	10	5706915938562	20	1	31.81	38.17	
10502487	4.5	82	126	10	5709131041966	20	1	34.39	41.27	
10504418	4.8	87	132	10	5706915944181	20	1	40.47	48.56	
10502488	5.0	87	132	10	5709131041993	20	1	44.49	53.39	
10504420	5.2	87	132	10	5706915944204	20	1	43.26	51.91	
10502489	5.5	91	139	10	5709131042013	20	1	45.14	54.17	
10502490	6.0	91	139	10	5709131042020	20	1	48.31	57.97	
10502491	6.5	97	148	10	5709131111856	20	1	67.78	81.34	
10502492	7.0	102	156	10	5709131042037	20	1	68.95	82.74	
10502493	7.5	102	156	5	5709131061762	20	1	38.74	46.49	
10502494	8.0	109	165	5	5709131042044	20	1	39.74	47.69	
10502495	8.5	109	165	5	5709131111900	20	1	42.39	50.87	
10502496	9.0	115	175	5	5709131061786	20	1	52.83	63.40	
10502497	9.5	115	175	5	5709131061793	20	1	56.24	67.49	
10502498	10.0	121	184	5	5709131042051	20	1	60.04	72.05	
10503858	12.0	134	205	5	5706915938586	10	1	106.77	128.12	

HSS PRO DOUBLE-ENDED DRILL BITS - BULK PACK



118° SPLIT POINT SHAPE for increased performance and very good centering
PARTICULARLY SUITABLE for drilling thin materials, especially for car body work and tubular rivet holes
DOUBLE LIFTETIME versus a single end drill bit
DIAMETERS adapted to most common blind rivets
SURFACE FINISH: Polished silver
PACKAGED in Quadro Pack

Item No.	Diameter mm	Working Length mm	Total length mm	Pcs per Pack	EAN	Master Pack	Shelf Pack	LP Ex VAT £ / Item	RRP Inc VAT £ / Item	DISC. CODE
1868262	3	11	46	10	5706918682622	50	1	12.60	15.12	PTA B
1868263	3.1	12	49	10	5706918682639	50	1	13.99	16.79	
1868264	3.2	12	49	10	5706918682646	50	1	13.99	16.79	
10502479	3.3	12	49	10	5709131041559	50	1	13.99	16.79	
1868265	3.5	14	52	10	5706918682653	50	1	13.99	16.79	
1868266	4	14	56	10	5706918682660	50	1	14.49	17.39	
10502480	4.1	14	56	10	5709131041634	50	1	14.49	17.39	

HSS PRO DOUBLE-ENDED DRILL BITS - BULK PACK

Item No.	Diameter mm	Working Length mm	Total length mm	Pcs per Pack	EAN	Master Pack	Shelf Pack	LP Ex VAT £ / Item	RRP Inc VAT £ / Item	DISC. CODE
1868267	4.2	14	56	10	5706918682677	50	1	14.49	17.39	PTA B
1868268	4.5	16	58	10	5706918682684	50	1	15.93	19.12	
1868269	4.8	17.5	62	10	5706918682691	50	1	15.93	19.12	
10502481	4.9	17.5	62	10	5709131041702	50	1	15.93	19.12	
1868270	5	17.5	62	10	5706918682707	50	1	15.93	19.12	
1868271	5.1	17.5	62	10	5706918682714	50	1	17.52	21.02	
1868272	5.2	17.5	62	10	5706918682721	50	1	17.52	21.02	



HSS PRO DRILL BITS - DIN 345 - TAPER SHANK

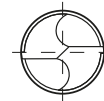

Item No.	Diameter mm	Working length mm	Total Length mm	Pcs per Pack	Shank Size	EAN	Master Pack	Shelf Pack	LP Ex VAT £ / Item	RRP Inc VAT £ / Item	DISC. CODE
10502418	10.0	87	168	5	MK 1	5709131039181	10	1	32.89	39.47	PTA B
10502419	10.5	87	168	5	MK 1	5709131039327	10	1	32.89	39.47	
10502420	11.0	94	175	5	MK 1	5709131039464	10	1	38.70	46.44	
10502422	12.0	101	182	5	MK 1	5709131039754	10	1	41.40	49.68	
10502424	13.0	101	182	5	MK 1	5709131040026	10	1	45.28	54.34	
10502425	13.5	108	189	5	MK 1	5709131040132	10	1	45.28	54.34	
10502426	14.0	108	189	1	MK 1	5709131040170	25	1	9.06	10.87	
10502427	14.5	114	212	1	MK 2	5709131040231	25	1	10.85	13.02	
10502428	15.0	114	212	1	MK 2	5709131040286	25	1	10.85	13.02	
10502429	15.5	120	218	1	MK 2	5709131040323	25	1	10.85	13.02	
10502430	16.0	120	218	1	MK 2	5709131040378	25	1	11.93	14.32	
10502431	16.5	125	223	1	MK 2	5709131040439	25	1	12.04	14.45	
10502432	17.0	125	223	1	MK 2	5709131040477	25	1	12.04	14.45	
10502433	17.5	130	228	1	MK 2	5709131040514	25	1	12.04	14.45	
10502434	18.0	130	228	1	MK 2	5709131040552	25	1	12.60	15.12	
10502435	18.5	135	233	1	MK 2	5709131040590	25	1	12.60	15.12	
10502436	19.0	135	233	1	MK 2	5709131040637	25	1	16.71	20.05	
10502437	19.5	140	238	1	MK 2	5709131040682	25	1	17.78	21.34	
10502438	20.0	140	238	1	MK 2	5709131040729	25	1	17.78	21.34	
10502439	20.5	145	243	1	MK 2	5709131040767	25	1	19.09	22.91	
10502440	21.0	145	243	1	MK 2	5709131040781	25	1	19.09	22.91	
10502441	21.5	150	248	1	MK 2	5709131040804	25	1	19.09	22.91	
10502442	22.0	150	248	1	MK 2	5709131040828	25	1	21.26	25.51	
10502443	22.5	155	253	1	MK 2	5709131040859	25	1	21.26	25.51	
10502444	23.0	155	253	1	MK 2	5709131040873	25	1	21.26	25.51	
10502445	23.5	160	281	1	MK 3	5709131040903	25	1	30.25	36.30	
10502446	24.0	160	281	1	MK 3	5709131040910	25	1	30.25	36.30	
10502447	24.5	160	281	1	MK 3	5709131040927	25	1	30.25	36.30	
10502448	25.0	160	281	1	MK 3	5709131040934	25	1	34.92	41.90	
10502450	26.0	165	286	1	MK 3	5709131040965	25	1	34.92	41.90	
10502451	26.5	165	286	1	MK 3	5709131040972	10	1	34.92	41.90	
10502452	27.0	170	291	1	MK 3	5709131040989	10	1	34.92	41.90	
10502453	27.5	170	291	1	MK 3	5709131040996	10	1	37.96	45.55	
10502454	28.0	170	291	1	MK 3	5709131041009	10	1	37.96	45.55	
10502456	29.0	175	296	1	MK 3	5709131041023	10	1	42.41	50.89	
10502458	30.0	175	296	1	MK 3	5709131041054	10	1	42.41	50.89	
10502460	31.0	180	301	1	MK 3	5709131041078	10	1	46.96	56.35	
10502461	31.5	180	301	1	MK 3	5709131041092	10	1	55.61	66.73	
10502462	32.0	185	334	1	MK 4	5709131041115	10	1	60.73	72.88	
10502464	33.0	185	334	1	MK 4	5709131041139	5	1	66.14	79.37	
10502466	34.0	190	339	1	MK 4	5709131041153	5	1	66.14	79.37	
10502468	35.0	190	339	1	MK 4	5709131041177	5	1	69.40	83.28	
10502470	36.0	195	344	1	MK 4	5709131041207	5	1	69.40	83.28	
10502474	38.0	200	349	1	MK 4	5709131041245	5	1	75.90	91.08	
10502478	40.0	200	349	1	MK 4	5709131041283	5	1	91.09	109.31	

118° CHISEL POINT SHAPE for maximum service life
 MORSE TAPER SHANK to Din 345 standard
FOR STATIONARY DRILLING
 SURFACE FINISH: Black oxide coating
 PACKAGED in Quadro Pack



IRWIN.

Unibit™



STEP DRILLS

DESIGNED FOR PRECISE DRILLING IN THIN MATERIALS



UNIBIT® STEP DRILLS

1. SELF CENTERING POINT

Will not walk, eliminates centre punching.

2. DRILL BIT BODY

Made from Chrome Vanadium Steel.
Hardened to 56 HRC.

3. FLUTE

Extra deep ground double flutes
for extra chip capacity.

4. IDEAL FOR DRILLING HOLES IN THIN MATERIALS

Such as mild steel, copper, brass, aluminium, plexiglass,
plastic, wood and laminates.

5. FLATTED SHANK

Prevents the drill bit from slipping in the chuck.

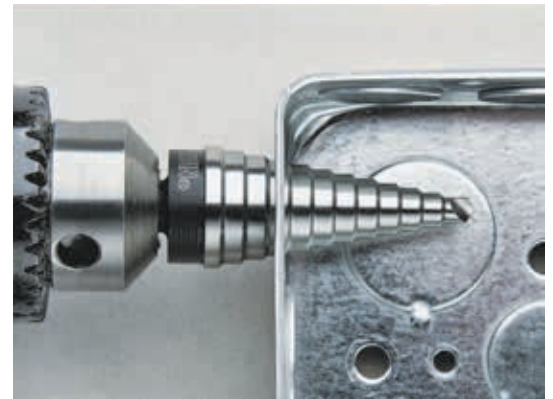
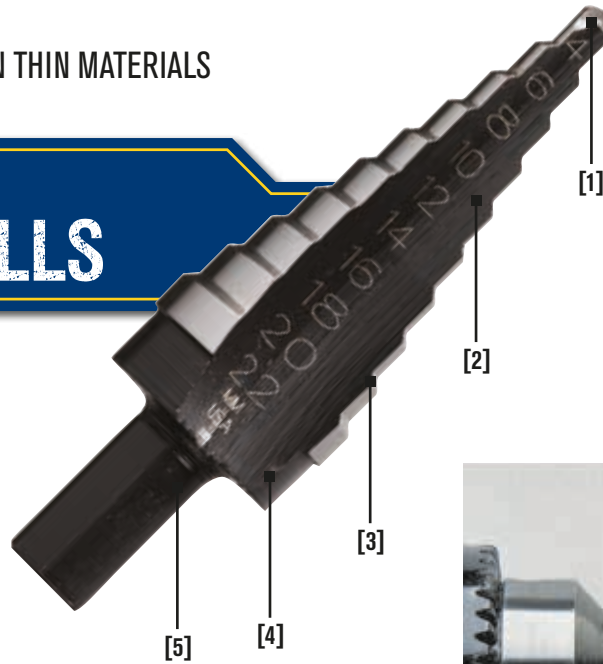

METAL DRILLING



10502850



10502851



10502852



10502853



10502854



10502855



10502856



10502863



10502864

Item No.	Description	EAN	Master Pack	Shelf Pack	LP Ex VAT £ / Item	RRP Inc VAT £ / Item	DISC CODE
10502850	1M 9 Hole sizes (4mm - 12mm), 1mm increments	0038548111018	5	1	21.23	25.48	PTA B
10502851	2M 5 Hole sizes (4mm - 12mm), 2mm increments	0038548111025	5	1	22.57	27.08	
10502852	3M 7 Hole sizes (6mm - 18mm), 2mm increments	0038548111032	5	1	30.24	36.29	
10502853	4M 10 Hole sizes (4mm - 22mm), 2mm increments	0038548111049	5	1	34.75	41.70	
10502854	5M 13 Hole sizes (5mm - 35mm), 2 - 3mm increments	0038548111056	5	1	62.80	75.36	
10502855	PG29M10 Hole sizes 5, 7.5, 10, 12.5, 15.2, 18.6, 20.4, 22.5, 25.5, 28.3mm	0038548111940	5	1	62.26	74.71	
10502856	29MM 10 Hole sizes 5, 7.5, 10, 13, 16, 19, 21, 23, 26, 29mm	0038548111957	5	1	62.79	75.35	
10502857	ISO/PG13 Hole sizes 5, 7.5, 9.7, 12.7, 15.2, 16.2, 18.6, 20.4, 22.5, 25.4, 28.3, 30.5, 32.5mm	0038548111967	5	1	107.72	129.26	
10502863	20M 6 Hole sizes (14 - 24mm)	0038548112206	5	1	54.43	65.32	
10502864	21M 8 Hole sizes (20 - 34mm)	0038548112213	5	1	86.05	103.26	



TCT

DESIGNED FOR DRILLING HARD AND ABRASIVE MATERIALS



CARBIDE TIP will drill hardened material up to a hardness of 50 HRC.

Four faceted ground for low drilling pressure and perfect centring

FLUTE Extra deep ground double flutes for extra chip capacity

BODY CLEARANCE Reduced flute land means less friction

DRILL BIT BODY made from Chrome Vanadium Steel. Hardened to 56 HRC

COOLANT should always be used when drilling with TCT Twist Drill Bits.

It is recommended to use a 3-6% emulsion. The coolant will extend the life time of the drill bit



TCT DRILL BITS

Item No.	Diameter mm	Working Length mm	Total length mm	EAN	Master Pack	Shelf Pack	LP Ex VAT £ / Item	RRP Inc VAT £ / Item	DISC. CODE
10502618	2.0	24	51	5709131042235	50	10	12.06	14.47	
10502619	2.5	30	57	5709131042372	50	10	12.06	14.47	
10502620	3.0	33	61	5709131042549	50	10	12.06	14.47	
10502621	3.1	39	70	5709131042570	50	10	12.06	14.47	
10502622	3.2	39	70	5709131042617	50	10	12.06	14.47	
10502624	3.3	39	70	5709131042662	50	10	12.06	14.47	
10502626	3.5	39	70	5709131042723	50	10	12.06	14.47	
10502627	3.6	43	75	5709131042761	50	10	12.06	14.47	
10502631	4.0	43	75	5709131042907	50	10	12.06	14.47	
10502633	4.2	47	80	5709131042976	50	10	12.06	14.47	
10502634	4.3	47	80	5709131043010	50	10	12.06	14.47	
10502636	4.5	47	80	5709131043089	50	10	12.06	14.47	
10502641	5.0	52	86	5709131043270	50	10	12.06	14.47	
10502642	5.1	57	93	5709131043324	50	10	12.32	14.78	
10502643	5.2	57	93	5709131043362	50	10	12.32	14.78	
10502644	5.3	57	93	5709131043409	50	10	12.32	14.78	
10502646	5.5	57	93	5709131043461	50	10	12.32	14.78	
10502649	5.8	57	93	5709131043577	50	10	12.32	14.78	
10502651	6.0	57	93	5709131043645	50	10	12.82	15.38	
10502656	6.5	63	101	5709131043829	50	10	13.51	16.21	
10502658	6.7	69	109	5709131043881	50	10	13.51	16.21	
10502659	6.8	69	109	5709131043935	50	10	14.27	17.12	
10502661	7.0	69	109	5709131043980	50	10	14.27	17.12	
10502662	7.1	69	109	5709131044017	50	10	14.27	17.12	
10502666	7.5	69	109	5709131044147	50	10	15.51	18.61	
10502671	8.0	75	117	5709131044307	50	10	16.66	19.99	
10502676	8.5	75	117	5709131044475	50	10	18.05	21.66	
10502680	9.0	81	125	5709131044659	50	10	19.29	23.15	
10502685	9.5	81	125	5709131044772	50	10	17.83	21.40	
10502689	10.0	87	133	5709131044949	50	10	22.34	26.81	
10502690	10.5	87	133	5709131045137	30	10	25.43	30.52	
10502691	11.0	94	142	5709131045274	30	10	25.93	31.12	
10502692	11.5	94	142	5709131045397	30	10	28.13	33.76	
10502693	12.0	101	151	5709131045564	30	10	30.48	36.58	
10502694	12.5	101	151	5709131045700	30	10	32.24	38.69	
10502695	13.0	101	151	5709131045847	30	10	35.62	42.74	
10502696	13.5	108	160	5709131045892	30	10	38.80	46.56	
10502697	14.0	108	160	5709131045922	30	10	42.59	51.11	
10502699	15.0	114	169	5709131045991	15	5	42.84	51.41	
10502701	16.0	120	178	5709131046097	15	5	43.93	52.72	

PTA B



IRWIN®

In 1885, Charles Irwin patented the Auger bit and, along with four business partners, formed the IRWIN® Auger Bit Company in Ohio, USA. Over 125 years later, IRWIN® is still the leading manufacturer of wood drilling bits and accessories. No matter what wood drilling project you face, IRWIN® Tools makes a drill bit that performs the job better. Our mark of quality is stamped right on the shank of our full range of bits. Whether the job requires quick, clean holes, or precise finish work, IRWIN® has a bit for every application and every need.

IRWIN® Blue Groove 4X and Blue Groove 6X wood boring bits raise-the-bar on tool quality and performance. Its cutting edge technology incorporates true "cutting edges" that glide through the wood versus scraping its way through. Professionals can now improve their productivity and accuracy with IRWIN®'s innovatives ranges. The latest generation Blue Groove Power is adding extreme durability thanks to Bi-Metal Technology.



FLAT BITS



BLUE GROOVE POWER



BLUE GROOVE 6X



BLUE GROOVE 4X

TRADITIONAL BITS



AUGER



BRAD POINT

EXTENSIONS



QUICK-CHANGE EXTENSIONS



STANDARD EXTENSIONS

BLUE GROOVE POWER WOOD BORING BITS THE LONGEST LASTING FLAT BIT EVER!



BLUE GROOVE POWER

1. EXTREME DURABILITY

Bi-metal cutting edges provide long life in tough applications.

2. FULL SCREW TIP

For ease of use and pull through.

3. TAPERED FLUTE

For less binding and ease of use.
'Tri-Flute' Design For faster chip ejection.

4. COMPACT LENGTH

Designed to fit between studs in most common applications.
1/4" Quick-Change Shank on Blue Groove Power 14-16mm. 3/8" Quick-Change Shank on Blue Groove Power 18-32mm.



WOOD DRILLING



* Up to 6 times faster than competitor products



* Up to 50 times more durable than competitor products.



Quick Change Shank

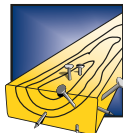

Nail-Embedded Wood

BLUE GROOVE POWER WOOD BORING BITS

Item No.	Description	EAN	Master Pack	Shelf Pack	LP Ex VAT £ / Item	RRP Inc VAT £ / Item	DISC CODE
10507712	BG Power 14mm	5706915077124	36	1	14.50	17.40	PTA B
10507713	BG Power 16mm	5706915077131	36	1	14.50	17.40	
10507714	BG Power 18mm	5706915077148	36	1	14.50	17.40	
10507715	BG Power 20mm	5706915077155	36	1	15.11	18.13	
10507716	BG Power 22mm	5706915077162	36	1	15.70	18.84	
10507717	BG Power 25mm	5706915077179	36	1	17.33	20.80	
10507718	BG Power 28mm	5706915077186	36	1	23.14	27.77	
10507719	BG Power 32mm	5706915077193	36	1	24.08	28.90	



ALSO AVAILABLE IN SETS
SEE PAGE 140



BLUE GROOVE 6X WOOD BORING BITS 6 TIMES FASTER THAN STANDARD FLAT BITS

BLUE GROOVE 6X

1. CUTTING SPURS

For clean holes with minimal 'break out'.

2. FULL SCREW TIP

For ease of use and pull through.

3. TAPERED FLUTE

For less binding and ease of use.

'Tri-Flute' Design for faster chip ejection.

4. FULL LENGTH HEAT TREAT

For extra durability.

5. COMPACT LENGTH

Designed to fit between studs in most common applications.

1/4" QUICK CHANGE SHANK



* Up to 6 times faster than competitor products

Saves Battery Life



Quick Change Shank



Wood

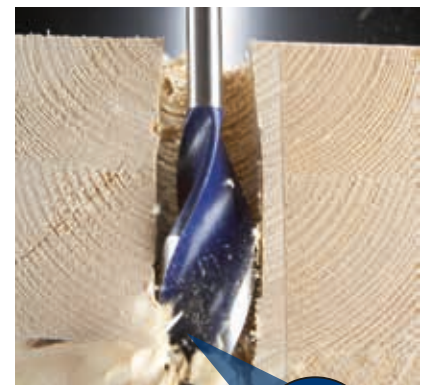

BLUE GROOVE 6X WOOD BORING BITS

Item No.	Description Ø mm	EAN	Master Pack	Shelf Pack	LP Ex VAT £ / Item	RRP Inc VAT £ / Item	DISC. CODE
1921930	Blue Groove 6X 14mm x 4" Clam	5706919219308	36	6	6.41	7.69	
1921991	Blue Groove 6X 16mm x 4" Clam	5706919219919	36	6	6.41	7.69	
1921992	Blue Groove 6X 18mm x 4" Clam	5706919219926	36	6	6.41	7.69	
1921993	Blue Groove 6X 20mm x 4" Clam	5706919219933	36	6	6.50	7.80	
1921994	Blue Groove 6X 22mm x 4" Clam	5706919219940	36	6	6.64	7.97	
1921995	Blue Groove 6X 25mm x 4" Clam	5706919219957	36	6	7.57	9.08	
1921996	Blue Groove 6X 28mm x 4" Clam	5706919219964	36	6	9.94	11.93	
1921997	Blue Groove 6X 32mm x 4" Clam	5706919219971	36	6	10.66	12.79	
10507602	Blue Groove 6X 14mm x 6" Clam	5706915076028	36	6	7.24	8.69	
10506620	Blue Groove 6X 16mm x 6" Clam	5706915066203	36	6	7.24	8.69	
10506621	Blue Groove 6X 18mm x 6" Clam	5706915066210	36	6	7.24	8.69	
10506622	Blue Groove 6X 20mm x 6" Clam	5706915066227	36	6	7.56	9.07	
10506623	Blue Groove 6X 22mm x 6" Clam	5706915066234	36	6	7.56	9.07	
10506624	Blue Groove 6X 25mm x 6" Clam	5706915066241	36	6	8.26	9.91	
10506625	Blue Groove 6X 28mm x 6" Clam	5706915066258	36	6	11.58	13.90	
10506626	Blue Groove 6X 32mm x 6" Clam	5706915066265	36	6	12.04	14.45	
1921998	Blue Groove 6X 14mm x 16" Clam	5706919219988	36	6	15.21	18.25	
1921999	Blue Groove 6X 16mm x 16" Clam	5706919219995	36	6	15.21	18.25	
1922000	Blue Groove 6X 18mm x 16" Clam	5706919220007	36	6	15.21	18.25	
1922001	Blue Groove 6X 20mm x 16" Clam	5706919220014	36	6	15.57	18.68	
1922002	Blue Groove 6X 22mm x 16" Clam	5706919220021	36	6	16.43	19.72	
1922003	Blue Groove 6X 25mm x 16" Clam	5706919220038	36	6	18.64	22.37	
1922004	Blue Groove 6X 28mm x 16" Clam	5706919220045	36	6	23.60	28.32	
1922005	Blue Groove 6X 32mm x 16" Clam	5706919220052	36	6	25.65	30.78	
1922006	Blue Groove 6X 16, 20, 25mm 4" 3pc Clam Set	5706919220069	36	3	19.60	23.52	
1922007	Blue Groove 6X 16, 18, 20, 22, 25mm inc. Extension 5pc Clam Set	5706919220076	36	3	43.50	52.20	
10506627	Blue Groove 6X, 3pc set: 20, 22, 25mm	5706915066272	6	1	21.17	25.40	
10506628	Blue Groove 6X, 6pc set: 16, 18, 20, 22, 25, 32mm	5706915066289	6	1	49.07	58.88	
10507604	Blue Groove 6X, 6pc set: 14, 16, 18, 20, 22, 25mm	5706915076042	6	1	49.07	58.88	

ALSO AVAILABLE IN SETS
SEE PAGE 141

BLUE GROOVE 4X FLAT BITS

4 TIMES FASTER THAN STANDARD FLAT BITS



* Up to 4 times faster versus basic flat bits
Saves Battery Life
Hex Shank
Wood

BLUE GROOVE 4X FLAT BITS - 152mm LENGTH

Item No.	Description	EAN	Master Pack	Shelf Pack	LP Ex VAT £ / Item	RRP Inc VAT £ / Item	DISC. CODE
10502803	6mm	0024721013811	36	6	4.95	5.94	PTA A
10502804	8mm	0024721013828	36	6	5.09	6.11	
10502805	10mm	0024721013835	36	6	5.05	6.06	
10502806	12mm	0024721013842	36	6	5.05	6.06	
10502807	13mm	0024721013859	36	6	5.05	6.06	
10502808	14mm	0024721013866	36	6	5.24	6.29	
10502809	16mm	0024721013873	36	6	5.58	6.70	
10502810	17mm	0024721889171	36	6	5.58	6.70	
10502811	18mm	0024721013880	36	6	5.58	6.70	
10502812	19mm	0024721013897	36	6	5.58	6.70	
10502813	20mm	0024721013903	36	6	5.80	6.96	
10502814	22mm	0024721013910	36	6	5.80	6.96	
10502815	24mm	0024721013934	36	6	6.11	7.33	
10502816	25mm	0024721013941	36	6	6.11	7.33	
10502817	26mm	0024721013958	36	6	8.90	10.68	
10502818	28mm	0024721013965	36	3	8.90	10.68	
10502819	30mm	0024721013972	36	3	9.12	10.94	
10502820	32mm	0024721013989	36	3	9.12	10.94	
10502821	35mm	0024721014009	36	3	9.43	11.32	
10502822	38mm	0024721014016	36	3	9.66	11.59	
10502823	40mm	0024721889409	36	3	9.66	11.59	

Double Cutting Spurs scribe outside of the hole, reducing breakout

Thicker Cutting Edge for longer drilling life
Bluegroove Point & Cutting Edge for faster chip removal

10% Larger shank for added durability

1/4" Hex shank prevents bit slipping in chuck



BLUE GROOVE 4X FLAT BITS - 400 mm LENGTH



Item No.	Description Ø mm	EAN	Master Pack	Shelf Pack	LP Ex VAT £ / Item	RRP Inc VAT £ / Item	DISC. CODE
10502830	6mm	0024721886064	36	6	9.67	11.60	PTA A
10502831	8mm	0024721886088	36	6	9.67	11.60	
10502832	10mm	0024721013064	36	6	9.67	11.60	
10502833	12mm	0024721014153	36	6	10.46	12.55	
10502834	13mm	0024721014184	36	6	10.84	13.01	
10502835	14mm	0024721013071	36	6	11.22	13.46	
10502836	16mm	0024721014191	36	6	11.62	13.94	
10502837	18mm	0024721014207	36	6	12.00	14.40	
10502838	19mm	0024721013088	36	6	12.37	14.84	
10502839	20mm	0024721014214	36	6	13.14	15.77	
10502840	22mm	0024721014221	36	6	11.22	13.46	
10502842	25mm	0024721014245	36	6	13.92	16.70	
10502843	28mm	0024721014269	18	3	14.70	17.64	
10502844	30mm	0024721014276	18	3	16.00	19.20	
10502845	32mm	0024721014283	18	3	15.45	18.54	
10502846	35mm	0024721014290	18	3	16.24	19.49	

For extended reach

Not for use with bit extensions or drill presses





LOCK-N-LOAD™ QUICK CHANGE EXTENSIONS



LOCK-N-LOAD™ SYSTEM for one-handed quick release

JAW DESIGN holds bits securely on 6-flatted shanks, as well as ball detent bits

1/4" QUICK CHANGE RANGE now holds insert bits

CARBON STEEL CONSTRUCTION

SLEEVE AND BODY for durability and life



LOCK-N-LOAD™ COMPATIBILITY

6,3 mm (1/4")	
	ALL POWER BITS
	ALL INSERT BITS
	ALL BLUE GROOVE 4X
	ALL BLUE GROOVE 6X
	BLUE GROOVE POWER 14 - 16mm
	STEP DRILLS 1M - 2M
9,5 mm (3/8")	
	STEP DRILLS (SIZE 3M - 4M)
	HOLE SAW ARBORS 9.5mm
	BLUE GROOVE POWER 18 - 32mm



Item No.	Description	EAN	Master Pack	Shelf Pack	LP Ex VAT £ / Item	RRP Inc VAT £ / Item	DISC CODE
10508166	1/4" Quick Change Bit Holder - 65 mm / 2,5"	5706915081664	48	6	9.84	11.81	PTA B
10508167	1/4" Quick Change Bit Holder - 150 mm / 6"	5706915081671	48	6	12.02	14.42	
10508168	1/4" Quick Change Bit Holder - 300 mm / 12"	5706915081688	48	6	14.76	17.71	
10508169	3/8" Quick Change Bit Holder - 70 mm / 2,75"	5706915081695	24	3	12.02	14.42	
10508170	3/8" Quick Change Bit Holder - 140 mm / 5,5"	5706915081701	24	3	14.76	17.71	
10508171	3/8" Quick Change Bit Holder - 300 mm / 12"	5706915081717	24	3	18.04	21.65	

AUGER

SOLID CENTER AUGER WITH CUTTING SPUR



The Original
AUGER

AUGER DRILL BITS

Item No.	Diameter mm	Working Length mm	Total length mm	Hex Faces mm	Hex Faces inches	EAN	Master Pack	Shelf Pack	LP Ex VAT £ / Item	RRP Inc VAT £ / Item	DISC CODE
10502738	5	73	150	3,9	5/32"	5709131135579	24	1	7.71	9.25	PTA B
10502739	6	114	191	4,8	3/16"	5709131133490	24	1	7.71	9.25	
10502740	6	323	400	4,8	3/16"	5709131133957	24	1	11.88	14.26	
10502741	8	114	191	5,6	7/32"	5709131133513	24	1	7.86	9.43	
10502742	8	323	400	5,6	7/32"	5709131133971	24	1	12.47	14.96	
10502744	10	114	191	7,9	5/16"	5709131133537	24	1	8.26	9.91	
10502745	10	323	400	7,9	5/16"	5709131133995	24	1	14.04	16.85	
10502747	11	114	191	7,9	5/16"	5709131133551	24	1	10.27	12.32	
10502748	12	114	191	7,9	5/16"	5709131133575	24	1	11.08	13.30	
10502749	12	323	400	7,9	5/16"	5709131134015	24	1	15.72	18.86	
10502751	13	114	191	7,9	5/16"	5709131133599	24	1	11.18	13.42	
10502752	13	323	400	7,9	5/16"	5709131134039	24	1	17.13	20.56	
10502754	14	126	191	7,9	5/16"	5709131133612	24	1	11.71	14.05	
10502755	14	335	400	7,9	5/16"	5709131134053	24	1	18.50	22.20	
10502756	15	126	191	7,9	5/16"	5709131133636	24	1	14.66	17.59	
10502757	16	126	191	7,9	5/16"	5709131133650	24	1	15.41	18.49	
10502758	16	335	400	7,9	5/16"	5709131134077	24	1	20.81	24.97	
10502760	17	126	191	7,9	5/16"	5709131133674	24	1	16.79	20.15	
10502761	18	126	191	7,9	5/16"	5709131133698	24	1	14.48	17.38	
10502762	18	335	400	7,9	5/16"	5709131134091	24	1	22.06	26.47	
10502764	19	126	191	7,9	5/16"	5709131133711	24	1	14.66	17.59	
10502765	19	335	400	7,9	5/16"	5709131134114	24	1	23.91	28.69	
10502766	20	126	191	7,9	5/16"	5709131133735	24	1	15.27	18.32	
10502767	20	335	400	7,9	5/16"	5709131134138	24	1	25.60	30.72	
10502769	22	126	191	7,9	5/16"	5709131133759	24	1	15.42	18.50	
10502770	22	335	400	7,9	5/16"	5709131134152	24	1	26.23	31.48	
10502772	24	126	191	7,9	5/16"	5709131133773	24	1	15.89	19.07	
10502773	24	335	400	7,9	5/16"	5709131134176	24	1	27.00	32.40	
10502774	25	126	191	7,9	5/16"	5709131133797	24	1	18.30	21.96	
10502775	25	335	400	7,9	5/16"	5709131134190	24	1	28.38	34.06	
10502776	26	126	191	11,1	7/16"	5709131133810	24	1	18.89	22.67	
10502777	26	335	400	11,1	7/16"	5709131134213	24	1	30.10	36.12	
10502778	28	175	240	11,1	7/16"	5709131133834	24	1	19.78	23.74	
10502779	28	335	400	11,1	7/16"	5709131134237	24	1	31.78	38.14	
10502780	30	175	240	11,1	7/16"	5709131133858	24	1	24.13	28.96	
10502781	30	335	400	11,1	7/16"	5709131134251	16	1	34.71	41.65	
10502782	32	175	240	11,1	7/16"	5709131133872	24	1	24.70	29.64	
10502783	32	335	400	11,1	7/16"	5709131134275	16	1	36.85	44.22	
10502784	35	175	240	11,1	7/16"	5709131133896	24	1	24.82	29.78	
10502785	35	335	400	11,1	7/16"	5709131134312	16	1	38.25	45.90	
10502786	36	335	400	11,1	7/16"	5709131134336	16	1	39.33	47.20	
10502787	38	175	240	11,1	7/16"	5709131133919	24	1	26.47	31.76	
10502788	40	175	240	11,1	7/16"	5709131133933	24	1	27.37	32.84	

COARSE SCREW POINT for faster drilling into all types of wood

SINGLE SPUR DESIGN for smoother hole finish

EXTRA WIDE FLUTE for faster chip removal
FULLY HARDENED BODY from tip to shank for extra durability

HEX SHANK prevents bit slipping in chuck

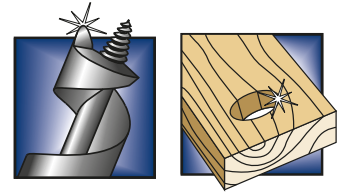

Perfect for all types of wood
Creates perfect and straight holes



WOOD DRILLING

AUGER DRILL BIT EXTENSIONS

Item No.	Description	EAN	Master Pack	Shelf Pack	LP Ex VAT £ / Item	RRP Inc VAT £ / Item	DISC CODE
10502789	5/16" (7,9mm) Extension 450mm for Auger Ø10 - 25mm	5709131134756	25	5	38.35	46.02	PTA B
10502790	7/16" (11,1mm) Extension 450mm for Auger Ø26 - 40mm	5709131134756	25	5	57.45	68.94	



BRAD POINT

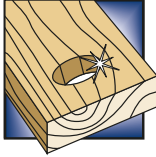

Perfect for all types of wood
Creates perfect and straight holes

Brad point tip provides accurate positioning for starting the hole

Bit is precision ground for use in furniture making, doweling, cabinetry and other woodworking applications where an exact hole size is required

Spur cutting edges reduce splintering and ensure a smooth, clean hole

Wide flutes provide a fast, continuous flow of chips

BRAD POINT PRECISE DRILLING OF CLEAN HOLES



BRAD POINT DRILL BITS

Item No.	Diameter mm	Working Length mm	Total length mm	EAN	Master Pack	Shelf Pack	LP Ex VAT \$ / Item	RRP Inc VAT \$ / Item	DISC. CODE
10502792	3.0	37	67	5709131134534	200	10	1.53	1.84	PTA B
10502793	4.0	52	88	5709131134558	200	10	1.62	1.94	
10502794	5.0	59	95	5709131134572	200	10	1.82	2.18	
10502795	6.0	67	103	5709131134596	200	10	1.91	2.29	
10502796	8.0	78	119	5709131134619	200	10	2.59	3.11	
10502797	10.0	87	136	5709131134633	200	10	3.09	3.71	
10502798	12.0	100	145	5709131134657	100	10	5.15	6.18	
10502799	13.0	104	149	5709131134671	100	10	5.69	6.83	
10502800	16.0	130	178	5709131134695	25	5	8.67	10.40	





IRWIN® IMPACT DOUBLE-ENDED BITS

- 1. DoubleLok Technology™**
Ensures both ends of bit lock securely in impact drivers and quick-change chucks, enabling use of two tips from one bit for added convenience and extended life
- 2. Precision tip geometry**
Delivers superior fitment, reducing stripping and cam-out
- 3. Power Groove**
Designed for compatibility with IRWIN® Impact Performance Series™ Magnetic Screw-Hold Attachment
- 4. Manufactured with heavy-duty, high-grade steel**
To withstand high torque output

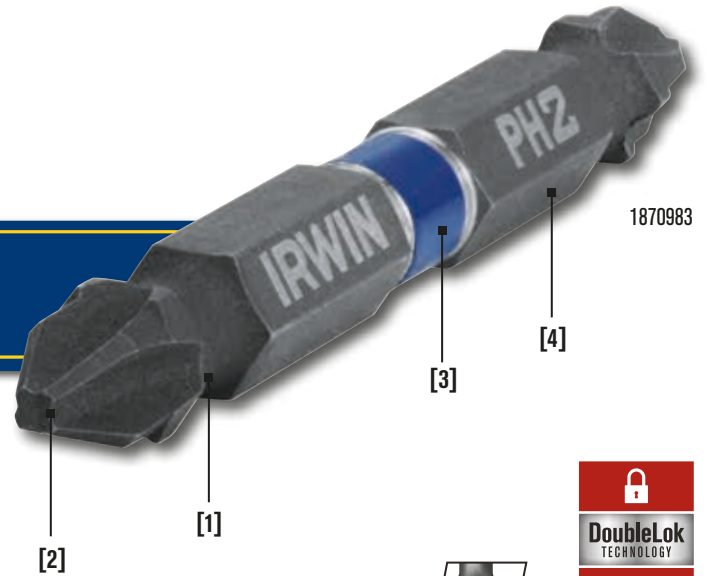

BETTER FIT.
LESS STRIPPING.*

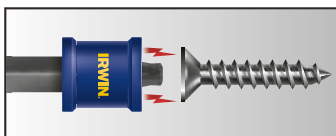
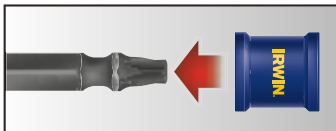

Compatible with IRWIN® Impact Performance Series Magnetic Screw-Hold Attachment**

Item No.	Product Description	EAN	Master Pack	Shelf Pack	LP Ex VAT £ / Item	RRP Inc VAT £ / Item	DISC. CODE
1923372	Impact Double-Ended Insert Bit - PH1 60mm - 2pcs	5706919233724	25	5	5.28	6.34	
1923373	Impact Double-Ended Insert Bit - PH1 60mm - 10pcs	5706919233731	60	10	21.29	25.55	
1923375	Impact Double-Ended Insert Bit - PH2 60mm - 2pcs	5706919233755	25	5	5.28	6.34	
1923376	Impact Double-Ended Insert Bit - PH2 60mm - 10pcs	5706919233762	60	10	21.29	25.55	
1923377	Impact Double-Ended Power Bit - PH2 100mm - 2pcs	5706919233779	25	5	6.60	7.92	
1923378	Impact Double-Ended Insert Bit - PH3 60mm - 2pcs	5706919233786	25	5	5.28	6.34	
1923381	Impact Double-Ended Insert Bit - T10 60mm - 2pcs	5706919233816	25	5	5.28	6.34	
1923383	Impact Double-Ended Insert Bit - T15 60mm - 2pcs	5706919233830	25	5	5.28	6.34	
1923385	Impact Double-Ended Insert Bit - T20 60mm - 2pcs	5706919233854	25	5	5.28	6.34	
1923386	Impact Double-Ended Power Bit - T20 100mm - 2pcs	5706919233861	25	5	6.60	7.92	
1923387	Impact Double-Ended Insert Bit - T25 60mm - 2pcs	5706919233878	25	5	5.28	6.34	
1923388	Impact Double-Ended Power Bit - T25 100mm - 2pcs	5706919233885	25	5	6.60	7.92	
1923391	Impact Double-Ended Insert Bit - T30 60mm - 2pcs	5706919233915	25	5	5.28	6.34	
1923392	Impact Double-Ended Power Bit - T30 100mm - 2pcs	5706919233922	25	5	6.60	7.92	
1923405	Impact Double-Ended Insert Bit - PZ1 60mm - 2pcs	5706919234059	25	5	5.28	6.34	
1923406	Impact Double-Ended Insert Bit - PZ1 60mm - 10pcs	5706919234066	60	10	21.29	25.55	
1923407	Impact Double-Ended Power Bit - PZ1 100mm - 2pcs	5706919234073	25	5	6.60	7.92	
1923408	Impact Double-Ended Insert Bit - PZ2 60mm - 2pcs	5706919234080	25	5	5.28	6.34	
1923409	Impact Double-Ended Insert Bit - PZ2 60mm - 10pcs	5706919234097	60	10	21.29	25.55	
1923410	Impact Double-Ended Power Bit - PZ2 100mm - 2pcs	5706919234103	25	5	6.60	7.92	
1923411	Impact Double-Ended Insert Bit - PZ3 60mm - 2pcs	5706919234110	25	5	5.28	6.34	
1923412	Impact Double-Ended Insert Bit - PZ3 60mm - 10pcs	5706919234127	60	10	21.29	25.55	
1923227	Impact Double-Ended Power Bit - PZ3 100mm - 2pcs	5706919232277	25	5	6.60	7.92	

*vs. standard screwdriving bits
**excludes T40, SL10-12, SL12-14, Hex 6 mm, Hex 8 mm, Hex 1/4"

Impact Screwdriving Bits

IRWIN® IMPACT SINGLE-ENDED BITS



Item No.	Product Description	EAN	Master Pack	Shelf Pack	LP Ex VAT £ / Item	RRP Inc VAT £ / Item	DISC CODE
1923286	Impact Single-Ended Insert Bit - PH1 25mm - 2pcs	5706919232864	25	5	4.06	4.87	PTA B
1923287	Impact Single-Ended Insert Bit - PH1 25mm - 10pcs	5706919232871	25	5	16.24	19.49	
1923289	Impact Single-Ended Insert Bit - PH2 25mm - 2pcs	5706919232895	25	5	4.06	4.87	
1923290	Impact Single-Ended Insert Bit - PH2 25mm - 10pcs	5706919232901	25	5	16.24	19.49	
1923321	Impact Single-Ended Insert Bit - PH2 25mm - 20pcs	5706919233212	10	1	30.45	36.54	
1923322	Impact Single-Ended Insert Bit - PH2 50mm - 2pcs	5706919233229	25	5	5.07	6.08	
1923323	Impact Single-Ended Insert Bit - PH3 25mm - 2pcs	5706919233236	25	5	4.06	4.87	
1923326	Impact Single-Ended Insert Bit - T10 25mm - 2pcs	5706919233267	25	5	4.06	4.87	
1923328	Impact Single-Ended Insert Bit - T15 25mm - 2pcs	5706919233281	25	5	4.06	4.87	
1923330	Impact Single-Ended Insert Bit - T20 25mm - 2pcs	5706919233304	25	5	3.85	4.62	
1923331	Impact Single-Ended Insert Bit - T20 25mm - 20pcs	5706919233311	10	1	30.45	36.54	
1923332	Impact Single-Ended Insert Bit - T20 50mm - 2pcs	5706919233328	25	5	5.07	6.08	
1923333	Impact Single-Ended Insert Bit - T25 25mm - 2pcs	5706919233335	25	5	4.06	4.87	
1923334	Impact Single-Ended Insert Bit - T25 50mm - 2pcs	5706919233342	25	5	5.07	6.08	
1923335	Impact Single-Ended Insert Bit - T27 25mm - 2pcs	5706919233359	25	5	4.06	4.87	
1923337	Impact Single-Ended Insert Bit - T30 25mm - 2pcs	5706919233373	25	5	4.06	4.87	
1923338	Impact Single-Ended Insert Bit - T30 25mm - 20pcs	5706919233380	10	1	30.45	36.54	
1923339	Impact Single-Ended Insert Bit - T30 50mm - 2pcs	5706919233397	25	5	5.07	6.08	
1923340	Impact Single-Ended Insert Bit - T40 25mm - 2pcs	5706919233403	25	5	4.06	4.87	
1923342	Impact Single-Ended Insert Bit - HEX3 25mm - 2pcs	5706919233427	25	5	4.06	4.87	
1923344	Impact Single-Ended Insert Bit - HEX4 25mm - 2pcs	5706919233441	25	5	4.06	4.87	
1923346	Impact Single-Ended Insert Bit - HEX5 25mm - 2pcs	5706919233465	25	5	4.06	4.87	
1923348	Impact Single-Ended Insert Bit - HEX6 25mm - 2pcs	5706919233489	25	5	4.06	4.87	
1923350	Impact Single-Ended Insert Bit - HEX8 25mm - 2pcs	5706919233502	25	5	4.06	4.87	
1923352	Impact Single-Ended Insert Bit - PZ1 25mm - 2pcs	5706919233526	25	5	4.06	4.87	
1923353	Impact Single-Ended Insert Bit - PZ1 25mm - 10pcs	5706919233533	25	5	16.24	19.49	
1923354	Impact Single-Ended Insert Bit - PZ1 50mm - 2pcs	5706919233540	25	5	5.07	6.08	
1923355	Impact Single-Ended Insert Bit - PZ2 25mm - 2pcs	5706919233557	25	5	4.06	4.87	
1923356	Impact Single-Ended Insert Bit - PZ2 25mm - 10pcs	5706919233564	25	5	16.24	19.49	
1923357	Impact Single-Ended Insert Bit - PZ2 25mm - 20pcs	5706919233571	60	10	30.45	36.54	
1923358	Impact Single-Ended Insert Bit - PZ2 50mm - 2pcs	5706919233588	25	5	5.07	6.08	
1923359	Impact Single-Ended Insert Bit - PZ3 25mm - 2pcs	5706919233595	25	5	4.06	4.87	
1923360	Impact Single-Ended Insert Bit - PZ3 25mm - 10pcs	5706919233601	25	5	16.24	19.49	
1923361	Impact Single-Ended Insert Bit - PZ3 50mm - 2pcs	5706919233618	25	5	5.07	6.08	
1923362	Impact Single-Ended Insert Bit - SLOT 3mm - 25mm - 2pcs	5706919233625	25	5	4.06	4.87	
1923364	Impact Single-Ended Insert Bit - SLOT 4.5mm - 25mm - 2pcs	5706919233649	25	5	4.06	4.87	
1923366	Impact Single-Ended Insert Bit - SLOT 5.5mm - 25mm - 2pcs	5706919233663	25	5	4.06	4.87	
1923368	Impact Single-Ended Insert Bit - SLOT 6.5mm - 25mm - 2pcs	5706919233687	25	5	4.06	4.87	
1923370	Impact Single-Ended Insert Bit - SLOT 8mm - 25mm - 2pcs	5706919233700	25	5	4.06	4.87	



Precision tip geometry delivers superior fitment, reducing stripping and cam-out
Power Groove designed for compatibility with IRWIN® Impact Performance Series™ Magnetic Screw-Hold Attachment
Manufactured with heavy-duty, high-grade steel to withstand high torque output



Precision Tip
BETTER FIT. LESS STRIPPING.*

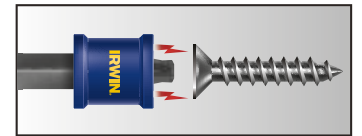
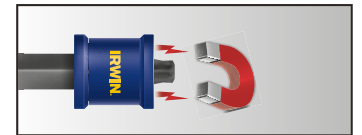
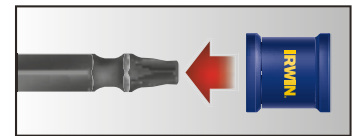

Compatible with IRWIN® Impact Performance Series Magnetic Screw-Hold Attachment**

*vs. standard screwdriving bits
 **excludes T40, SL10-12, SL12-14, Hex 6 mm, Hex 8 mm & Hex 1/4"

SCREWDRIVING

QUICK-CHANGE BIT EXTENSIONS

Item No.	Description	EAN	Master Pack	Shelf Pack	LP Ex VAT £ / Item	RRP Inc VAT £ / Item	DISC CODE
1923502	Impact Quick-Change Extension Bit - 2.5" - 1pc	5706919235025	48	3	15.38	18.46	PTA B
1923413	Impact Quick-Change Extension Bit - 6" - 1pc	5706919234134	48	3	18.79	22.55	
1923414	Impact Quick-Change Extension Bit - 12" - 1pc	5706919234141	48	3	23.07	27.68	

BIT HOLDERS

Item No.	Description	EAN	Master Pack	Shelf Pack	LP Ex VAT £ / Item	RRP Inc VAT £ / Item	DISC CODE
1923228	Impact Bit Holder - 3" - 1pc	5706919232284	25	5	8.14	9.77	PTA B
1923229	Impact Bit Holder - 6" - 1pc	5706919232291	25	5	12.79	15.35	
1923501	Impact Magnetic Screw Holder - 1pc	5706919235018	25	5	3.44	4.13	

RIGHT ANGLE DRILL / DRIVE TOOL

Item No.	Description	EAN	Master Pack	Shelf Pack	LP Ex VAT £ / Item	RRP Inc VAT £ / Item	DISC CODE
1923415	Impact Angle Drill / Drive Tool - 1pc	5706919234158	36	3	29.99	35.99	PTA B





1. COMPACT, PORTABLE DESIGN:

Compact, portable design allows for easy transport to and from the worksite, and ease-of-use while on the job

2. MOULDED ABS RESIN CASE:

Moulded ABS resin case holds up to rigors of daily use

3. EASY-TO-READ SIZE MARKINGS:

Easy-to-read size markings provide simple identification of set contents

4. CONVENIENT BIT HOLDER STORAGE COMPARTMENT

Incorporated into top of case (insert bit cases only)



1923419

IMPACT INSERT BIT 10PC POCKET CASE SET

Holds (9) 1" insert bits and a bit holder

Item No.	Description	EAN	Master Pack	Shelf Pack	LP Ex VAT £ / Item	RRP Inc VAT £ / Item	DISC. CODE
1923419	Impact Insert Bit PH Set, 10pcs: 2 x PH1 / 5 x PH2 / 2 x PH3 + Bit Holder	5706919234196	36	3	24.24	29.09	PTA B
1923420	Impact Insert Bit PZ Set, 10pcs: 2 x PZ1 / 5 x PZ2 / 2 x PZ3 + Bit Holder	5706919234202	36	3	24.24	29.09	
1923431	Impact Insert Bit TX Set, 10pcs: T10 / 2 x T15 / 2 x T20 / 2 x T25 / T30 / T40 + Bit Holder	5706919234318	36	3	24.24	29.09	
1923432	Impact Insert Bit Mixed Set, 10pcs: 4 x PZ2 / 4 x PH2 / T20 + Bit Holder	5706919234325	36	3	24.24	29.09	



1923434

IMPACT POWER BIT 5PC POCKET CASE SET

Holds (5) 2" power bits

Item No.	Description	EAN	Master Pack	Shelf Pack	LP Ex VAT £ / Item	RRP Inc VAT £ / Item	DISC. CODE
1923433	Impact Power Bit PZ / PH / TX Set, 5pcs: PZ2 x 2 / PH2 x 2 / T20	5706919234332	36	6	17.33	20.80	PTA B
1923434	Impact Power Bit PH Set, 5pcs: PH2 x 5	5706919234349	36	6	17.33	20.80	
1923435	Impact Power Bit PZ Set, 5pcs: PZ2 x 5	5706919234356	36	6	17.33	20.80	



1923416

IMPACT INSERT BIT 5PC SET

Item No.	Description	EAN	Master Pack	Shelf Pack	LP Ex VAT £ / Item	RRP Inc VAT £ / Item	DISC. CODE
1923416	Impact Insert Bit PZ / PH Mag Set, 5pcs: 2 x PZ2 / 2 x PH2 plus 1903524	5706919234165	25	5	12.12	14.54	PTA B
1923417	Impact Insert Bit PH Mag Set, 5pcs: 4 x PH2 plus 1903524	5706919234172	25	5	12.12	14.54	
1923418	Impact Insert Bit PZ Mag Set, 5pcs: 4 x PZ2 plus 1903524	5706919234189	25	5	12.12	14.54	

IRWIN® IMPACT PRO SET CASES

1. TWO-STEP EASY IN / OUT BIT STORAGE

Holds bits securely in place until ready for use

2. MOULDED ABS RESIN CASE:

Moulded ABS resin case holds up to rigors of daily use

3. FULL-LENGTH METAL PIN IN HINGE

For added durability and life



IMPACT BIT 22PC PRO CASE SET

Item No.	Description	EAN	Master Pack	Shelf Pack	LP Ex VAT £ / Item	RRP Inc VAT £ / Item	DISC CODE
1923436	PH1 X 2 / PH2 X 4 / PH3 X 1 / PZ1 X 2 / PZ2 X 4 / PZ3 X 1 / TX20 X 4 / TX30 X 3 / 1903524	5706919234363	6	1	48.48	58.18	PTA B



IMPACT BIT 32PC PRO CASE SET

Item No.	Description	EAN	Master Pack	Shelf Pack	LP Ex VAT £ / Item	RRP Inc VAT £ / Item	DISC CODE
1923437	Insert Bits (25mm)- PH1 x 2 / PH2 x 3 / PH3 x 2 / PZ1 x 2 / PZ2 x 3 / PZ3 x 2 / TX20 x 3 / TX30 x 2 / TX25 x 2 Power Bit (50mm) - PH2 x 5 / PZ x 5 / 3" Holder	5706919234370	6	1	55.79	66.95	PTA B



IRWIN® Insert Bits are engineered for use in hand-driving applications or with power tools when used with the IRWIN® Insert Bit Holder.

IRWIN® Power Bits are specifically designed for the higher torque requirements of power tools. They are designed to provide more clearance between the power tool & the fastener.



PHILLIPS, INSERT BITS

Item No.	Description	EAN	Master Pack	Shelf Pack	LP Ex VAT £ / Item	RRP Inc VAT £ / Item	DISC. CODE
10504387	Phillips Ph1 - 1/4"/25mm - 2 pcs	5706915043877	10	1	1.09	1.31	PTA B
10504388	Phillips Ph2 - 1/4"/25mm - 2 pcs	5706915043884	10	1	1.09	1.31	
10504389	Phillips Ph3 - 1/4"/25mm - 2 pcs	5706915043891	10	1	1.09	1.31	
10504390	Phillips Ph1 - 1/4"/50mm - 2 pcs	5706915043907	10	1	1.26	1.51	
10504391	Phillips Ph2 - 1/4"/50mm - 2 pcs	5706915043914	10	1	1.26	1.51	
10504336	Phillips Ph2 - 1/4"/50mm - 5 pcs	5706915043365	10	1	4.27	5.12	
10504330	Phillips Ph1 - 1/4"/25mm - 10 pcs	5706915043303	10	1	4.88	5.86	
10504331	Phillips Ph2 - 1/4"/25mm - 10 pcs	5706915043310	10	1	4.88	5.86	
10504332	Phillips Ph3 - 1/4"/25mm - 10 pcs	5706915043327	10	1	4.88	5.86	
10504337	ProPak Phillips Ph2 - 1/4"/25mm 10 x 10pcs pack in display box	5706915043372	-	10*	4.44	5.33	



PHILLIPS - TITANIUM COATED, INSERT BITS

Item No.	Description	EAN	Master Pack	Shelf Pack	LP Ex VAT £ / Item	RRP Inc VAT £ / Item	DISC. CODE
10504392	Phillips Ph2 TiN - 1/4"/25mm - 2 pcs	5706915043921	10	1	1.93	2.32	PTA B
10504333	Phillips Ph1 TiN - 1/4"/25mm - 10 pcs	5706915043334	10	1	7.09	8.51	
10504334	Phillips Ph2 TiN - 1/4"/25mm - 10 pcs	5706915043341	10	1	7.09	8.51	
10504335	Phillips Ph3 TiN - 1/4"/25mm - 10 pcs	5706915043358	10	1	7.09	8.51	



PHILLIPS, POWER BITS

Item No.	Description	EAN	Master Pack	Shelf Pack	LP Ex VAT £ / Item	RRP Inc VAT £ / Item	DISC. CODE
10504395	Phillips Ph1 - 1/4"/50mm - 2 pcs	5706915043952	10	1	1.27	1.52	PTA B
10504396	Phillips Ph2 - 1/4"/50mm - 2 pcs	5706915043969	10	1	1.27	1.52	
10504363	Phillips Ph1 - 1/4"/50mm - 5 pcs	5706915043631	10	1	3.87	4.64	
10504364	Phillips Ph2 - 1/4"/50mm - 5 pcs	5706915043648	10	1	3.87	4.64	
10504365	Phillips Ph2 - 1/4"/70mm - 1 pcs	5706915043655	10	1	1.18	1.42	
10504366	Phillips Ph2 - 1/4"/90mm - 1 pcs	5706915043662	10	1	1.52	1.82	
10504367	Phillips Ph3 - 1/4"/50mm - 5 pcs	5706915043679	10	1	3.87	4.64	



POZIDRIV, INSERT BITS

Item No.	Description	EAN	Master Pack	Shelf Pack	LP Ex VAT £ / Item	RRP Inc VAT £ / Item	DISC. CODE
10504397	Pozidriv Pz1 - 1/4"/25mm - 2 pcs	5706915043976	10	1	1.09	1.31	PTA B
10504398	Pozidriv Pz2 - 1/4"/25mm - 2 pcs	5706915043983	10	1	1.09	1.31	
10504399	Pozidriv Pz3 - 1/4"/25mm - 2 pcs	5706915043990	10	1	1.09	1.31	
10504400	Pozidriv Pz1 - 1/4"/50mm - 2 pcs	5706915044003	10	1	1.26	1.51	
10504401	Pozidriv Pz2 - 1/4"/50mm - 2 pcs	5706915044010	10	1	1.26	1.51	
10504338	Pozidriv Pz1 - 1/4"/25mm - 10 pcs	5706915043389	10	1	4.88	5.86	
10504339	Pozidriv Pz2 - 1/4"/25mm - 10 pcs	5706915043396	10	1	4.88	5.86	
10504340	Pozidriv Pz3 - 1/4"/25mm - 10 pcs	5706915043402	10	1	4.88	5.86	
10504344	Pozidriv Pz2 - 1/4"/50mm - 5 pcs	5706915043440	10	1	4.27	5.12	
10504345	ProPak Pz2 Pozidriv - 10 x 10pcs pack in display box	5706915043457	-	10*	4.44	5.33	



POZIDRIV - TITANIUM COATED, INSERT BITS

Item No.	Description	EAN	Master Pack	Shelf Pack	LP Ex VAT £ / Item	RRP Inc VAT £ / Item	DISC. CODE
10504402	Pozidriv Pz2 TiN - 1/4"/25mm - 2 pcs	5706915044027	10	1	1.93	2.32	PTA B
10504341	Pozidriv Pz1 TiN - 1/4"/25mm - 10 pcs	5706915043419	10	1	7.09	8.51	
10504342	Pozidriv Pz2 TiN - 1/4"/25mm - 10 pcs	5706915043426	10	1	7.09	8.51	
10504343	Pozidriv Pz3 TiN - 1/4"/25mm - 10 pcs	5706915043433	10	1	7.09	8.51	

* Bulk packed products are priced per single item and can only be ordered in multiples of shelf pack quantity

POZIDRIV, POWER BITS

Item No.	Description	EAN	Master Pack	Shelf Pack	LP Ex VAT £ / Item	RRP Inc VAT £ / Item	DISC CODE
10504406	Pozidriv Pz2 - 1/4"/50mm - 2 pcs	5706915044065	10	1	1.27	1.52	PTA B
10504368	Pozidriv Pz1 - 1/4"/50mm - 5 pcs	5706915043686	50	1	3.87	4.64	
10504369	Pozidriv Pz2 - 1/4"/50mm - 5 pcs	5706915043693	50	1	3.87	4.64	
10504370	Pozidriv Pz2 - 1/4"/70mm - 1 pcs	5706915043709	10	1	1.18	1.42	
10504371	Pozidriv Pz2 - 1/4"/90mm - 1 pcs	5706915043716	10	1	1.52	1.82	
10504372	Pozidriv Pz3 - 1/4"/50mm - 5 pcs	5706915043723	10	1	3.87	4.64	



PHILLIPS/POZIDRIV, DOUBLE-END BITS

Item No.	Description	EAN	Master Pack	Shelf Pack	LP Ex VAT £ / Item	RRP Inc VAT £ / Item	DISC CODE
10504393	Phillips Ph1/Ph2 - Double End 50mm - 2 pcs	5706915043938	10	1	1.16	1.39	PTA B
10504394	Phillips Ph2/Ph2 - Double End 50mm - 2 pcs	5706915043945	10	1	1.16	1.39	
10504403	Pozidriv Pz1/Pz2 - Double End 50mm - 2 pcs	5706915044034	10	1	1.16	1.39	
10504404	Pozidriv Pz2/Pz2 - Double End 50mm - 2 pcs	5706915044041	10	1	1.16	1.39	



TORX, INSERT BITS

Item No.	Description	EAN	Master Pack	Shelf Pack	LP Ex VAT £ / Item	RRP Inc VAT £ / Item	DISC CODE
10504837	Torx T15 - 1/4"/25mm - 2 pcs	5706915048377	200	10	1.58	1.90	PTA B
10504838	Torx T20 - 1/4"/25mm - 2 pcs	5706915048384	200	10	1.58	1.90	
10504839	Torx T25 - 1/4"/25mm - 2 pcs	5706915048391	200	10	1.58	1.90	
10504840	Torx T30 - 1/4"/25mm - 2 pcs	5706915048407	200	10	1.58	1.90	
10504351	Torx T10 - 1/4"/25mm - 10 pcs	5706915043518	10	1	6.44	7.73	
10504352	Torx T15 - 1/4"/25mm - 10 pcs	5706915043525	10	1	6.44	7.73	
10504353	Torx T20 - 1/4"/25mm - 10 pcs	5706915043532	10	1	6.44	7.73	
10504354	Torx T25 - 1/4"/25mm - 10 pcs	5706915043549	10	1	6.44	7.73	
10504355	Torx T27 - 1/4"/25mm - 10 pcs	5706915043556	10	1	6.44	7.73	
10504356	Torx T30 - 1/4"/25mm - 10 pcs	5706915043563	10	1	6.44	7.73	
10504357	Torx T40 - 1/4"/25mm - 10 pcs	5706915043570	10	1	6.44	7.73	



TORX, POWER BITS

Item No.	Description	EAN	Master Pack	Shelf Pack	LP Ex VAT £ / Item	RRP Inc VAT £ / Item	DISC CODE
10504373	Torx T20 - 1/4"/50mm - 5 pcs	5706915043730	10	1	4.71	5.65	PTA B
10504374	Torx T25 - 1/4"/50mm - 5 pcs	5706915043747	10	1	4.71	5.65	
10504375	Torx T30 - 1/4"/50mm - 5 pcs	5706915043754	10	1	4.71	5.65	
10504376	Torx T40 - 1/4"/50mm - 5 pcs	5706915043761	10	1	4.71	5.65	



SLOTTED, INSERT BITS

Item No.	Description	EAN	Master Pack	Shelf Pack	LP Ex VAT £ / Item	RRP Inc VAT £ / Item	DISC CODE
10504358	Slotted 0,5 x 3,0mm - 1/4"/25mm - 10 pcs	5706915043587	60	10	4.26	5.11	PTA B
10504359	Slotted 0,6 x 4,5mm - 1/4"/25mm - 10 pcs	5706915043594	60	10	4.26	5.11	
10504360	Slotted 0,8 x 5,5mm - 1/4"/25mm - 10 pcs	5706915043600	60	10	4.26	5.11	
10504361	Slotted 1,2 x 6,5mm - 1/4"/25mm - 10 pcs	5706915043617	60	10	4.26	5.11	
10504362	Slotted 1,6 x 8,0mm - 1/4"/25mm - 10 pcs	5706915043624	60	10	4.89	5.87	



HEXAGONAL, INSERT BITS

Item No.	Description	EAN	Master Pack	Shelf Pack	LP Ex VAT £ / Item	RRP Inc VAT £ / Item	DISC CODE
10504346	Hexagonal 3,0mm - 1/4"/25mm - 10 pcs	5706915043464	60	10	4.39	5.27	PTA B
10504347	Hexagonal 4,0mm - 1/4"/25mm - 10 pcs	5706915043471	60	10	4.39	5.27	
10504348	Hexagonal 5,0mm - 1/4"/25mm - 10 pcs	5706915043488	60	10	4.39	5.27	
10504349	Hexagonal 6,0mm - 1/4"/25mm - 10 pcs	5706915043495	60	10	4.89	5.87	
10504350	Hexagonal 8,0mm - 1/4"/25mm - 10 pcs	5706915043501	60	10	4.89	5.87	



GRABIT JARS

Item No.	Description	EAN	Master Pack	Shelf Pack	LP Ex VAT £ / Item	RRP Inc VAT £ / Item	DISC CODE
10504383	Grabit Jar Pozidriv Pz2 - 1/4"/25mm, 250 pcs	5706915043839	4	1	53.95	64.74	PTA B
10504384	Grabit Jar Phillips Ph2 - 1/4"/25mm, 250 pcs	5706915043846	4	1	53.95	64.74	



PORTABLE, DURABLE CASE THAT KEEPS BITS ORGANISED

IRWIN® Pocket Cases feature a compact, portable design that makes it simple to take the bits you need to get the job done. The convenient moulded ABS resin cases hold up to anything the jobsite can throw at them and include easy-to-read size markings for simple identification of the set contents. Plus, the 10-piece pocket case features an easy-to-access bit holder storage compartment right on top.

IRWIN® POCKET CASES

1. COMPACT, PORTABLE DESIGN:

Compact, portable design allows for easy transport to and from the worksite, and ease-of-use while on the job

2. MOULDED ABS RESIN CASE:

Moulded ABS resin case holds up to rigors of daily use

3. EASY-TO-READ SIZE MARKINGS:

Easy-to-read size markings provide simple identification of set contents

4. FOR 10PC Pocket Case ONLY:

BIT HOLDER STORAGE:

Convenient bit holder storage compartment incorporated in top of case.



SMALL POCKET CASES

Item No.	Description	EAN	Master Pack	Shelf Pack	LP Ex VAT £ / Item	RRP Inc VAT £ / Item	DISC. CODE
1868193	IR 5PC PB Pocket Set (PH-PZ-TX): PB assorted, 5pc set: PH2 / PZ2 / T15 / T20 / T25	5706918681939	-	6	8.23	9.88	PTA B
1868194	IR 5PC PB Pocket Set (PH-PZ-SL): PB assorted, 5pc set: PH1 / PH2 / PZ1 / PZ2 / SL6.5	5706918681946	-	6	8.23	9.88	



LARGE POCKET CASES

Item No.	Description	EAN	Master Pack	Shelf Pack	LP Ex VAT £ / Item	RRP Inc VAT £ / Item	DISC. CODE
1868195	IR 10PC IB Pocket Set (PH): IB Philips, 10pc set: 2xPH1 / 5xPH2 / 2xPH3 + Bit Holder	5706918681953	-	6	12.97	15.56	PTA B
1868196	IR 10PC IB Pocket Set (PZ): IB Pazzi, 10pc set: 2xPZ1 / 5xPZ2 / 2xPZ3 + Bit Holder	5706918681960	-	6	12.97	15.56	
1868197	IR 10PC IB Pocket Set (TX): IB Torx, 10pc set: T10/2xT15/2xT20/2xT25/ T30/T40 + Bit Holder	5706918681977	-	6	12.97	15.56	
1868198	IR 10PC IB Pocket Set (PH2-PZ2-T20): IB assorted, 10pc set: 4xPZ2 / 4xPH2 / T20 + Bit Holder	5706918681984	-	6	12.97	15.56	
1868199	IR 10PC IB Pocket Set (PH-PZ-TX): IB assorted, 10pc set: PZ1/PZ2/PZ3/ PH1/PH2/PH3/T15/T20/T25 + Bit Holder	5706918681991	-	6	12.97	15.56	
1868200	IR 10PC IB Pocket Set (PH-PZ): IB assorted, 10pc set: PZ1 / 4xPZ2 / PZ3 / 3xPH2 + Bit Holder	5706918682004	-	6	12.97	15.56	

COMPACT, EASY-TO-STORE CASE THAT CAN ORGANISE A WIDE VARIETY OF BITS.

IRWIN® Drawer Cases feature a compact, flat design for enhanced portability and convenient storage in drawers and tool cabinets. The durable moulded ABS resin cases hold up to the daily rigors of shop-life and anything the jobsite can throw at them. The easy-to-read size markings make for simple identification of the set contents, and when not in use, the case stays securely closed with an easy-to-use sliding latch.

IRWIN® DRAWER CASES

1. COMPACT, PORTABLE DESIGN:

Compact, flat design for convenient storage in drawers and tool cabinets

2. MOULDED ABS RESIN CASE:

Moulded ABS resin case holds up to rigors of daily use

3. EASY-TO-READ SIZE MARKINGS:

Easy-to-read size markings provide simple identification of set contents

4. SECURE CLOSURE:

Easy-to-use sliding latch design keeps case securely closed when not in use



FASTENER DRIVES

SMALL DRAWER CASES

Item No.	Description	EAN	Master Pack	Shelf Pack	LP Ex VAT £ / Item	RRP Inc VAT £ / Item	DISC CODE
1868251	IR 30PC SL DRAWER SET ASSORTED: 1B assorted, 31pc small drawer case: PH1/2xPH2/PH3/PZ1/2xPZ2/PZ3/SL4-5/SL6-8/SL8-10/HEX4/HEX5/HEX6/2xT10/4xT15/4xT20/3xT25/2xT30/T40 + Bit Holder	5706918682516	-	6	24.62	29.54	PTA B

LARGE DRAWER CASES

Item No.	Description	EAN	Master Pack	Shelf Pack	LP Ex VAT £ / Item	RRP Inc VAT £ / Item	DISC CODE
1868252	IR 58PC LG DRAWER SET ASSORTED: 1B/PB assorted, 58pc large drawer case: 3xPH1/10xPH2/2xPH3/3xPZ1/10xPZ2/2xPZ3/SL3-4/SL4-5/SL6-8/SL8-10/HEX3/HEX4/HEX5/HEX6/2xT10/2xT15/2xT20/2xT25/2xT30/2xT40 + Powerbits PH2/PZ1/PZ2/PZ3/T15/T20/T25 + Bit Holder	5706918682523	-	6	37.07	44.48	PTA B



POWER BIT HOLDERS



Item No.	Description	EAN	Master Pack	Shelf Pack	LP Ex VAT £ / Item	RRP Inc VAT £ / Item	DISC CODE
10504377	50mm Magnetic Bit Holder 1/4"	5706915043778	200	10	4.39	5.27	PTA B
10504378	75mm Magnetic Bit Holder 1/4"	5706915043785	200	10	7.29	8.75	
10504379	SDS Magnetic Bit Holder	5706915043792	200	10	12.50	15.00	
10504380	Quick-Release Bit Holder 1/4"	5706915043808	200	10	7.76	9.31	
10504381	80mm Screw Drive Guide 9.5mm diameter	5706915043815	200	10	3.87	4.64	

BOLT-GRIP

Professionals don't waste time fighting rounded-off, rusted tight or painted-over bolts. They reach for the BOLT-GRIP. A unique, reverse spiral flute design securely grips and removes stubborn nuts and bolts.



Item No.	Description	EAN	Master Pack	Shelf Pack	LP Ex VAT £ / Item	RRP Inc VAT £ / Item	DISC CODE
10504634	5 Piece Base Set: 3/8", 7/16" (11mm), 1/2", 9/16" (14mm), 5/8" (16mm)	0024721012579	-	5	30.64	36.77	PTA B
10504635	5 Piece Expansion Set: 5/16" (8mm), 10mm, 13mm, 11/16", 3/4" (19mm)	0024721016126	-	5	24.03	28.84	
394100	Powergrip Set: 3/16" - 1/2", 7 pcs	0024721037633	-	5	34.91	41.89	
54125	5 Piece Speciality Set: 3/4" (19mm), 13/16" (21mm), 7/8" (22mm), 15/16" (24mm), 1" (25mm)	0024721541253	-	1	76.55	91.86	

Maximum gripping power reverse spiral flutes are designed to bite down

Tougher than tool steel high carbon steel ensures longer life and greater durability

Works with most tools 3/8" square drive for use with hand ratchets, impact wrenches & air ratchets; hexagonal flats for use with flat wrench, pliers, adjustable wrench, sockets or VISE-GRIP® locking pliers

Grips both metric and imperial universal lobular design Fits all types of fasteners





MASONRY

SPEEDHAMMER™ POWER DRILL SETS



10507183



10507537



10507538

Item No.	Description	EAN	Master Pack	Shelf Pack	LP Ex VAT £ / Item	RRP Inc VAT £ / Item	DISC. CODE
10507183	SPDH Power 5pc set: 6/8 x 110, 6/8/10 x 160mm	5706915071832	25	1	38.12	45.74	PTA A
10507537	SPDH Power 5pc set: 5/6 x 110, 7/8/10 x 160mm	5706915075373	25	1	38.12	45.74	
10507538	SPDH Power 9pc set: 6/6/8 x 110, 6/6/8/8/10/12 x 160mm	5706915075380	6	1	55.27	66.32	



SPEEDHAMMER™ PLUS DRILL BIT SETS



10502089



10503843



10507111

Item No.	Description	EAN	Master Pack	Shelf Pack	LP Ex VAT £ / Item	RRP Inc VAT £ / Item	DISC. CODE
10502089	SPDH Plus 5pc set: 5/6/8/10/12 x 160mm	5709131268871	25	1	22.23	26.68	PTA A
10503843	SPDH Plus 5pc set: 5.5/6/7/8/10 x 160mm	5706915038439	32	8	20.60	24.72	
10507110	SPDH Plus 9pc set: 5/5.5/6 x 110, 5.5/6/6/8/10/12 x 160mm	5706915071108	6	1	29.30	35.16	
10507111	SPDH Plus 9pc set: 5/6/6/8 x 110, 6/6/8/10/12 x 160mm	5706915071115	6	1	29.30	35.16	

SPEEDHAMMER™ PLUS DEMOLITION CHISELS



Item No.	Description	EAN	Master Pack	Shelf Pack	LP Ex VAT £ / Item	RRP Inc VAT £ / Item	DISC. CODE
10502201	Demolition Chisels 3pc set: Pointed, Flat & Spade	5709131285571	-	1	28.60	34.32	PTA B

CORDLESS MULTI DRILL BIT CASSETTES

**CORDLESS
MULTI**



10501938

10501939

10501940

Item No.	Description	EAN	Master Pack	Shelf Pack	LP Ex VAT £ / Item	RRP Inc VAT £ / Item	DISC. CODE
10501938	Cordless Multi 5pc set: 4/5/6/8/10mm	5709131247715	60	15	26.57	31.88	PTA A
10501939	Cordless Multi 5pc set: 5/5.5/6/8/10mm	5709131247692	60	15	20.63	24.76	
10501940	Cordless Multi 7pc set: 4/5/6/7/8/10/12mm	5709131247708	32	8	28.90	34.68	

MASONRY DRILL BIT CASSETTES

MASONRY



10501892

10503847

10501893

Item No.	Description	EAN	Master Pack	Shelf Pack	LP Ex VAT £ / Item	RRP Inc VAT £ / Item	DISC. CODE
10501892	Masonry 5pc set: 4/5/6/8/10mm	5709131248125	60	15	12.09	14.51	PTA A
10503847	Masonry 5pc set: 5/5.5/6/6.5/7mm	5706915038477	60	15	10.59	12.71	
10501893	Masonry 7pc set: 4/5/6/7/8/10/12mm	5709131248149	32	8	20.17	24.20	

GRANITE DRILL BIT CASSETTES

GRANITE



10501917

10501918

Item No.	Description	EAN	Master Pack	Shelf Pack	LP Ex VAT £ / Item	RRP Inc VAT £ / Item	DISC. CODE
10501917	Granite 5pc set: 4/5/6/8/10mm	5709131248187	60	15	21.96	26.35	PTA A
10501918	Granite 7pc set: 4/5/6/7/8/10/12mm	5709131248194	32	8	19.65	23.58	

GLASS & TILES

GLASS AND TILE DRILL BITS



Item No.	Description	EAN	Master Pack	Shelf Pack	LP Ex VAT £ / Item	RRP Inc VAT £ / Item	DISC. CODE
10507912	Glass & Tile 5 pc set: 4/5/6/8/10mm	5706915079128	120	10	17.46	20.95	PTA B

DIAMOND

DIAMOND DRILL BITS



10507900

10507901

Item No.	Description	EAN	Master Pack	Shelf Pack	LP Ex VAT £ / Item	RRP Inc VAT £ / Item	DISC. CODE
10507900	Diamond 4pc set: 5/6/7/8mm	5706915079005	60	1	88.68	106.42	PTA B
10507901	Diamond 4pc set: 6/8/10/15mm	5706915079012	60	1	102.01	122.41	PTA B

METAL

TURBO MAX

TURBOMAX™ HSS DRILL BIT SETS



10502234

10503992

10502233

Item No.	Description	EAN	Master Pack	Shelf Pack	LP Ex VAT £ / Item	RRP Inc VAT £ / Item	DISC. CODE
10502234	HSS Turbomax, 5pc set: 4/5/6/8/10mm	5709131266167	15	1	22.98	27.58	PTA B
10503992	HSS Turbomax, 15pc set: 1,5 to 10,0mm	5706915039924	6	1	53.25	63.90	PTA B
10502233	HSS Turbomax, 19pc set in metal case: 1,0 - 10,0mm in steps of 0,5mm	5709131240693	5	1	57.93	69.52	PTA B

HSS PRO COBALT DRILL BIT SETS

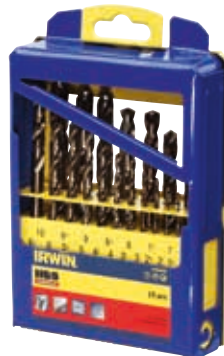

10502570

10503990

10502569

10503730

Item No.	Description	EAN	Master Pack	Shelf Pack	LP Ex VAT £ / Item	RRP Inc VAT £ / Item	DISC. CODE
10502570	HSS Cobalt, 5pc set: 4/5/6/8/10mm	5709131282464	45	15	22.93	27.52	PTA A
10503990	HSS Cobalt, 15pc set: 1,5 to 10,0mm	5706915039900	6	1	48.21	57.85	
10502569	HSS Cobalt, 19pc set in metal case: 1,0 - 10,0mm in steps of 0,5mm	5709131282433	25	5	70.33	84.40	
10503730	HSS Cobalt, 25pc set in metal case: 1,0 - 13,0mm in steps of 0,5mm	5706915037302	4	1	153.77	184.52	

HSS TITANIUM DRILL BIT SETS



10502604

10503991

10502603

Item No.	Description	EAN	Master Pack	Shelf Pack	LP Ex VAT £ / Item	RRP Inc VAT £ / Item	DISC. CODE
10502604	HSS Titanium, 5pc set: 4/5/6/8/10mm	5709131282471	45	15	11.29	13.55	PTA A
10503991	HSS Titanium, 15pc set: 1,5 to 10,0mm	5706915039917	6	1	27.90	33.48	
10502603	HSS Titanium, 19pc set in metal case: 1,0 - 10,0mm in steps of 0,5mm	5709131282440	25	5	35.57	42.68	



HSS PRO DRILL BIT SETS



10502499

10503989

10502500

10502504

Item No.	Description	EAN	Master Pack	Shelf Pack	LP Ex VAT £ / Item	RRP Inc VAT £ / Item	DISC. CODE
10502499	HSS Pro, 5pc set: 4/5/6/8/10mm	5709131282457	60	15	14.46	17.35	
10503989	HSS Pro, 15pc set: 1,5 to 10,0mm	5706915039894	6	1	22.08	26.50	PTA B
10502500	HSS Pro, 19pc set in metal case: 1,0 - 10,0mm in steps of 0,5mm	5709131284628	20	5	31.33	37.60	
10502504	HSS Pro, 25pc set in metal case: 1,0 - 13,0mm in steps of 0,5mm	5709131284659	16	4	59.93	71.92	

MIXED DRILL BIT SET



Item No.	Description	EAN	Master Pack	Shelf Pack	LP Ex VAT £ / Item	RRP Inc VAT £ / Item	DISC. CODE
10503993	Combi, 15pc set: HSS Pro: 2/3/3,5/4/5/6/8mm; Cordless Multi: 4/5/6/8mm; Brad Point: 3/4/6/8mm	5706915039931	6	1	30.15	36.18	PTA B



WOOD

BLUE GROOVE POWER WOOD BORING BIT SETS



10507720

10507764

Item No.	Description	EAN	Master Pack	Shelf Pack	LP Ex VAT £ / Item	RRP Inc VAT £ / Item	DISC. CODE
10507720	BG Power, 3pc set: 14/16/18mm	5706915077209	36	1	43.48	52.18	PTA B
10507764	BG Power, 3pc set: 20/22/25mm	5706915077643	36	1	48.14	57.77	

BLUE GROOVE 6X WOOD BORING BIT SETS



10506627



10506628



10507604



Item No.	Description Ø mm	EAN	Master Pack	Shelf Pack	LP Ex VAT £ / Item	RRP Inc VAT £ / Item	DISC. CODE
1922006	Blue Groove 6X 16, 20, 25mm 4" 3pc Clam Set NEW	5706919220069	36	3	19.60	23.52	PTA B
1922007	Blue Groove 6X 16, 18, 20, 22, 25mm inc. Extension 5pc Clam Set NEW	5706919220076	36	3	43.50	52.20	
10506627	Blue Groove 6X, 3pc set: 20, 22, 25mm NEW	5706915066272	6	1	21.17	25.40	
10506628	Blue Groove 6X, 6pc set: 16, 18, 20, 22, 25, 32mm	5706915066289	6	1	49.07	58.88	
10507604	Blue Groove 6X, 6pc set: 14, 16, 18, 20, 22, 25mm	5706915076042	6	1	49.07	58.88	

BLUE GROOVE 4X FLAT DRILL BIT SETS



10502826



10506629



10507603



Item No.	Description	EAN	Master Pack	Shelf Pack	LP Ex VAT £ / Item	RRP Inc VAT £ / Item	DISC. CODE
10502826	Blue Groove 4X, 6pc set: 10/13/16/19/22/25mm	0024721253149	6	1	33.11	39.73	PTA A
10506629	Blue Groove 4X, 8pc set: 12/16/18/20/22/25/28/32mm	5706915066296	6	1	38.53	46.24	
10507603	Blue Groove 4X, 8pc set: 12/14/16/18/20/22/25/28mm	5706915076035	6	1	38.53	46.24	

LARGE BIT SETS



10504385



10504386



10504382

Item No.	Description	EAN	Master Pack	Shelf Pack	LP Ex VAT £ / Item	RRP Inc VAT £ / Item	DISC. CODE
10504385	SCB, 30pc set: PH1, 5xPH2, PH3, PZ1, 5xPZ2, PZ3, T20, T25, T30, T40, SL6-8, SL8-10, SL10-12, Nut Set: 6, 8, 10, 12, Double ends: PH2/PH2, PZ2/PZ1, 2xPZ2/PZ2, Bit Holder	5706915043853	12	6	25.45	30.54	PTA B
10504386	SCB, 31pc set: PH1, 5xPH2, PH3, PZ1, 5xPZ2, PZ3, 2xPH2TiN, 2xPZ2TiN, SL6-8, SL8-10, SL10-12, Powerbits: 3xPH2, 3xPZ2, Double ends: PH2/PH2, PZ2/PZ1, PZ2/PZ2, Bit Holder	5706915043860	12	6	20.50	24.60	
10504382	Bit Dispenser, 270pc set: PZ2 50mm, PZ1 50mm, PH2 50mm, PH1 50mm, 1/4" Bit Holder, PZ2 TiN, PZ3, PZ2, PZ1, PH2 TiN, PH3, PH2, PH1	5706915043822	4	1	95.46	114.55	
3057011DS	7pcs Fastener Drive Set: 2x PH2, 2x SQ, SL8-10, Compact Magnetic Drive Guide	0673765086741	6	1	8.58	10.30	
3057013DS	13pcs Fastener Drive Set: 1x PH1, 4x PH2, 1x PH3, 1x SQ1, 3x SQ3, 3x SL8-10, Magnetic Drive Guide	0673765086734	6	1	9.77	11.72	
1840465	21pcs Fastener Drive Set: 10x PH2, 5x SQ2, 5x SL8-10, Magnetic Drive Guide	5706918404651	6	1	14.80	17.76	



Marples®

At the heart of quality craftsmanship lies the rich heritage of Marples® woodworking tools. Originating in 1828 in Sheffield, England, the Marples® brand has consistently stood for superior performance and ultimate precision in fine woodworking.

Marples® is traditionally famous for chisels and synonymous with high-quality woodworking tools. The new range of Circular Saw Blades made in Udine, Italy uses best-in-class manufacturing capabilities and processes giving a range fitting of the Marples® brand.



The WeldTec platform combines various attributes to deliver long lasting performance.

WeldTec on Circular Saw Blades is the welding of teeth to the blade as opposed to the traditional brazing teeth. This is ideal for handheld corded and cordless blades as the weld provides a strong bond in case of unexpected nail strikes or foreign objects embedded in wood.



HAND-HELD

STATIONARY

CORDLESS

CORDED

MITRE

TABLE





IRWIN® MARPLES®

1. LIFE, DURABILITY, SHARPNESS

Carbide is larger and tougher than standard carbide for 3x longer life resharpenable



[1]

2. ACCURACY, CLEAN CUT

Laser cut blade body for straighter, cleaner cuts

3. ACCURACY, CLEAN CUT

Precision Tensioning for Greater Accuracy

4. SMOOTH FEEL, NO BINDING, COATING

Special coating with aluminum flakes helps to dissipate heat for smooth, cool cuts



[2]

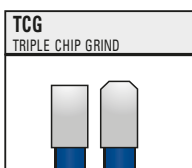
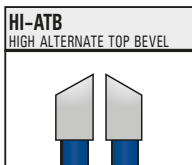
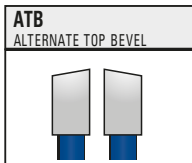
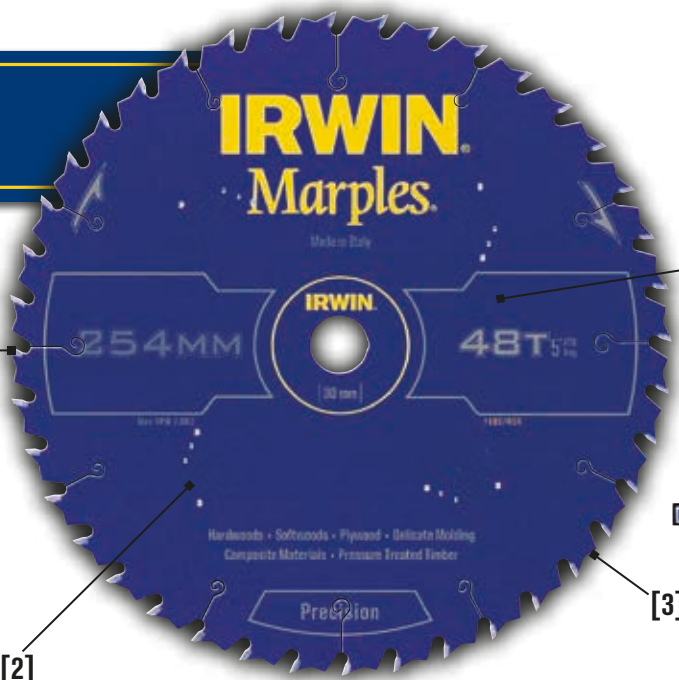

Item No.	Product Description	Category	Category	Diameter	Tooth Count	Arbor/Bore	Kerf Thickness	Tooth Config.	LP Ex VAT \$ / Item	RRP Inc VAT \$ / Item	DISC CODE
1897453	HPP 216mm/24T	Stationary	Mitre	216	24	30	2.5	ATB/N	63.20	75.84	PTA B
1897454	HPP 216mm/48T	Stationary	Mitre	216	48	30	2.5	ATB/N	81.25	97.50	
1897455	HPP 216mm/60T	Stationary	Mitre	216	60	30	2.5	ATB/N	89.29	107.15	
1897456	HPP 250mm/48T	Stationary	Mitre	250	48	30	2.5	ATB/N	87.44	104.93	
1897457	HPP 250mm/60T	Stationary	Mitre	250	60	30	2.5	ATB/N	100.46	120.55	
1897458	HPP 250mm/80T	Stationary	Mitre	250	80	30	2.5	HI-ATB/N	122.79	147.35	
1897459	HPP 254mm/48T	Stationary	Mitre	254	48	30	2.5	ATB/N	90.06	108.07	
1897460	HPP 254mm/60T	Stationary	Mitre	254	60	30	2.5	ATB/N	103.47	124.16	
1897461	HPP 254mm/80T	Stationary	Mitre	254	80	30	2.5	HI-ATB/N	127.69	153.23	
1897462	HPP 260mm/48T	Stationary	Mitre	260	48	30	2.5	ATB/N	92.76	111.31	
1897463	HPP 260mm/60T	Stationary	Mitre	260	60	30	2.5	ATB/N	106.57	127.88	
1897464	HPP 260mm/80T	Stationary	Mitre	260	80	30	2.5	HI-ATB/N	131.51	157.81	
1897465	HPP 305mm/48T	Stationary	Mitre	305	48	30	2.5	ATB/N	94.25	113.10	
1897466	HPP 305mm/60T	Stationary	Mitre	305	60	30	2.5	ATB/N	109.13	130.96	
1897467	HPP 305mm/96T	Stationary	Mitre	305	96	30	2.5	HI-ATB/N	141.39	169.67	
1897474	HPP 250mm/24T	Stationary	Table & Mitre	250	24	30	3.2	ATB	74.39	89.27	
1897475	HPP 250mm/40T	Stationary	Table & Mitre	250	40	30	3.2	ATB	87.34	104.81	
1897476	HPP 250mm/60T	Stationary	Table & Mitre	250	60	30	3.2	ATB	107.23	128.68	
1897477	HPP 250mm/80T	Stationary	Table & Mitre	250	80	30	3.2	ATB	129.52	155.42	
1897478	HPP 300mm/24T	Stationary	Table & Mitre	300	24	30	3.2	ATB	85.57	102.68	
1897479	HPP 300mm/48T	Stationary	Table & Mitre	300	48	30	3.2	ATB	105.69	126.83	
1897480	HPP 300mm/60T	Stationary	Table & Mitre	300	60	30	3.2	ATB	118.36	142.03	
1897468	HPP 216mm/84T	Multi	Multi	216	84	30	2.5	TCG/N	117.20	140.64	
1897469	HPP 250mm/84T	Multi	Multi	250	84	30	2.5	TCG/N	122.79	147.35	
1897470	HPP 254mm/84T	Multi	Multi	254	84	30	2.5	TCG/N	126.46	151.75	
1897471	HPP 260mm/84T	Multi	Multi	260	84	30	2.5	TCG/N	130.25	156.30	
1897472	HPP 300mm/96T	Multi	Multi	300	96	30	3.2	TCG	159.64	191.57	
1897473	HPP 305mm/100T	Multi	Multi	305	100	30	2.5	TCG/N	160.00	192.00	

Stationary, Table & Mitre

CONSTRUCTION

Item No.	Product Description	Category	Category	Diameter	Tooth Count	Arbor/Bore	Kerf Thickness	Tooth Config.	LP Ex VAT £ / Item	RRP Inc VAT £ / Item	DISC. CODE
1897395	Construction 216mm/24T M	Stationary	Mitre	216	24	30	2	ATB	45.01	54.01	PTA B
1897396	Construction 216mm/48T M	Stationary	Mitre	216	48	30	2	ATB	55.24	66.29	
1897397	Construction 216mm/60T M	Stationary	Mitre	216	60	30	2	ATB	65.48	78.58	
1897398	Construction 250mm/48T M	Stationary	Mitre	250	48	30	2.8	ATB	67.52	81.02	
1897426	Construction 250mm/60T M	Stationary	Mitre	250	60	30	2.8	ATB	75.71	90.85	
1897427	Construction 250mm/80T M	Stationary	Mitre	250	80	30	2.8	ATB	87.99	105.59	
1897428	Construction 254mm/48T M	Stationary	Mitre	254	48	30	2.8	ATB	69.54	83.45	
1897429	Construction 254mm/60T M	Stationary	Mitre	254	60	30	2.8	ATB	77.97	93.56	
1897430	Construction 254mm/80T M	Stationary	Mitre	254	80	30	2.8	ATB	90.63	108.76	
1897431	Construction 260mm/48T M	Stationary	Mitre	260	48	30	2.8	ATB	71.62	85.94	
1897432	Construction 260mm/60T M	Stationary	Mitre	260	60	30	2.8	ATB	79.80	95.76	
1897433	Construction 260mm/80T M	Stationary	Mitre	260	80	30	2.8	ATB	92.08	110.50	
1897434	Construction 305mm/48T M	Stationary	Mitre	305	48	30	3.2	ATB	73.56	88.27	
1897435	Construction 305mm/60T M	Stationary	Mitre	305	60	30	3.2	ATB	81.53	97.84	
1897436	Construction 305mm/96T M	Stationary	Mitre	305	96	30	3.2	ATB	115.37	138.44	
1897448	Construction 250mm/24T	Stationary	Table & Mitre	250	24	30	3.2	ATB	53.94	64.73	
1897449	Construction 250mm/40T	Stationary	Table & Mitre	250	40	30	3.2	ATB	65.11	78.13	
1897450	Construction 250mm/60T	Stationary	Table & Mitre	250	60	30	3.2	ATB	76.27	91.52	
1897451	Construction 300mm/48T	Stationary	Table & Mitre	300	48	30	3.2	ATB	82.84	99.41	
1897452	Construction 300mm/60T	Stationary	Table & Mitre	300	60	30	3.2	ATB	92.61	111.13	
1897437	MM CSB 160mm/48T	Stationary	Multi	160	48	20	2.4	TCG	53.47	64.16	
1897438	MM CSB 165mm/48T	Stationary	Multi	165	48	30	2.4	TCG	55.24	66.29	
1897439	MM CSB 184mm/48T	Stationary	Multi	184	48	30	2.4	TCG	59.34	71.21	
1897440	MM CSB 190mm/48T	Stationary	Multi	190	48	30	2.4	TCG	63.39	76.07	
1897441	MM CSB 210mm/84T	Stationary	Multi	210	60	30	2.5	TCG	81.84	98.21	
1897442	MM CSB 216mm/84T	Stationary	Multi	216	84	30	2.5	TCG	87.99	105.59	
1897443	MM CSB 250mm/84T	Stationary	Multi	250	84	30	2.5	TCG	94.13	112.96	
1897444	MM CSB 254mm/84T	Stationary	Multi	254	84	30	2.6	TCG	96.94	116.33	
1897445	MM CSB 260mm/84T	Stationary	Multi	260	84	30	2.6	TCG	99.85	119.82	
1897446	MM CSB 300mm/96T	Stationary	Multi	300	96	30	3.2	TCG	122.65	147.18	
1897447	MM CSB 305mm/84T	Stationary	Multi	305	84	30	2.6	TCG	119.81	143.77	



Expansion slots to dissipate heat and prevent warping
Construction grade tungsten carbide tips retain their edge longer and are resharpenable
Fully hardened plate
Alternate top bevel tooth grind (ATB) for cross cutting and ripping in all woods
Corrosion-resistant coating for longer, quality performance

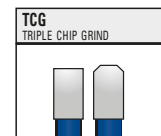
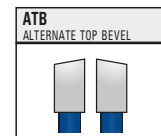

Item No.	Product Description	Category	Category	Diameter	Tooth Count	Arbor/Bore	Kerf Thickness	Tooth Config.	LP Ex VAT £ / Item	RRP Inc VAT £ / Item	DISC. CODE
1897209	CSB 216mm/24T M	Stationary	Table & Mitre	216	48	30	2.5	ATB	43.36	52.03	PTA B
1897210	CSB 250mm/24T	Stationary	Table & Mitre	250	24	30	3.0	ATB	37.79	45.35	
1897211	CSB 250mm/40T	Stationary	Table & Mitre	250	40	30	3.0	ATB	48.48	58.18	
1907700	CSB 250mm/60T	Stationary	Table & Mitre	250	60	30	3	ATB	59.41	71.29	
1897212	CSB 300mm/48T	Stationary	Table & Mitre	300	48	30	3.2	ATB	63.73	76.48	
1897213	CSB 300mm/60T	Stationary	Table & Mitre	300	60	30	3.2	ATB	71.23	85.48	
1897214	CSB 315mm/40T	Stationary	Table & Mitre	315	40	30	3.2	ATB	61.04	73.25	
1897215	CSB 350mm/40T	Stationary	Table & Mitre	350	40	30	3.5	ATB	81.21	97.45	
1897346	CSB 350mm/84T	Stationary	Table & Mitre	350	84	30	3.5	ATB	108.36	130.03	
1897347	CSB 400mm/40T	Stationary	Table & Mitre	400	40	30	3.8	ATB	86.17	103.40	
1897348	CSB 400mm/60T	Stationary	Table & Mitre	400	60	30	3.8	ATB	93.57	112.28	



Expansion slots to dissipate heat and prevent warping
Construction grade tungsten carbide tips retain their edge longer and are resharpenable
Fully hardened plate
Alternate top bevel tooth grind (ATB) for cross cutting and ripping in all woods
Corrosion-resistant coating for longer, quality performance

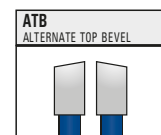

CIRCULAR SAW BLADES



WeldTec for Hand Held Coded & Cordless

WITH **WELDTEC™**

IRWIN® WELDTEC

- 1. WELDED CARBIDE TEETH**
30% Stronger tooth bond and for 50% longer life
- 2. ULTRA-COMPACT CARBIDE**
70% Tougher than standard carbide for superior sharpness and cut quality
- 3. INNOVATIVE HEAT VENTS**
- 4. FULLY HARDENED PLATE**
Runs truer longer with more accuracy (Life and Durability)
- 5. ALTERNATE TOP BEVEL**
Tooth grind (ATB) for cross cutting and ripping in all woods

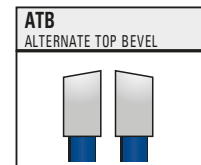
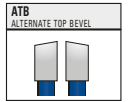
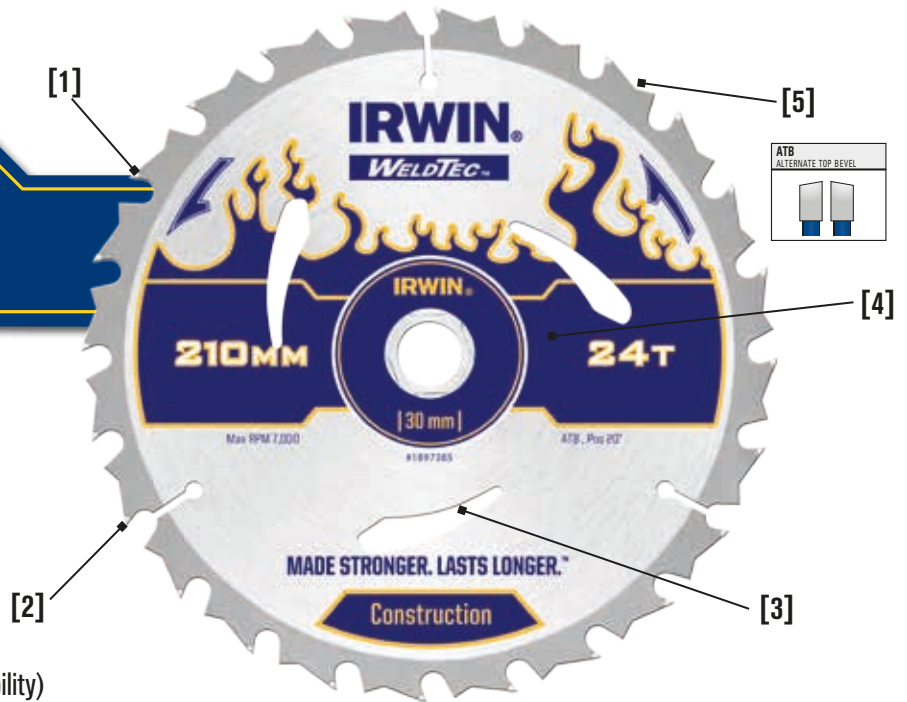

Item No.	Product Description	Category	Category	Diameter	Tooth Count	Arbor/Bore	Reductions	Kerf Thickness	Tooth Config.	LP Ex VAT £ / Item	RRP Inc VAT £ / Item	DISC CODE
1897349	WELDTEC 150mm/24T	Handheld	Corded	150	24	20	16	2.4	ATB	29.93	35.92	PTA B
1897350	WELDTEC 150mm/40T	Handheld	Corded	150	40	20	16	2.4	ATB	36.36	43.63	
1897361	WELDTEC 160mm/18T	Handheld	Corded	160	18	20	16	2.4	ATB	27.80	33.36	
1897362	WELDTEC 160mm/24T	Handheld	Corded	160	24	20	16	2.4	ATB	32.07	38.48	
1897363	WELDTEC 160mm/40T	Handheld	Corded	160	40	20	16	2.4	ATB	38.49	46.19	
1897364	WELDTEC 165mm/18T	Handheld	Corded	165	18	30	20	2.4	ATB	32.07	38.48	
1897365	WELDTEC 165mm/24T	Handheld	Corded	165	24	30	20	2.4	ATB	36.36	43.63	
1897366	WELDTEC 165mm/40T	Handheld	Corded	165	40	30	20	2.4	ATB	42.78	51.34	
1897368	WELDTEC 184mm/24T AR30	Handheld	Corded	184	24	30	20	2.4	ATB	32.70	39.24	
1897369	WELDTEC 184mm/24T AR16	Handheld	Corded	184	24	16	NO	2.4	ATB	31.58	37.90	
1897370	WELDTEC 184mm/40T AR30	Handheld	Corded	184	40	30	20	2.4	ATB	42.16	50.59	
1897381	WELDTEC 184mm/40T AR16	Handheld	Corded	184	40	16	NO	2.4	ATB	42.16	50.59	
1897382	WELDTEC 190mm/18T	Handheld	Corded	190	18	30	20	2.4	ATB	36.05	43.26	
1897383	WELDTEC 190mm/24T	Handheld	Corded	190	24	30	20	2.4	ATB	36.29	43.55	
1897384	WELDTEC 190mm/40T	Handheld	Corded	190	40	30	20	2.4	ATB	44.95	53.94	
1897385	WELDTEC 210mm/24T	Handheld	Corded	210	24	30	20	2.4	ATB	47.05	56.46	
1897386	WELDTEC 210mm/40T	Handheld	Corded	210	40	30	20	2.4	ATB	53.47	64.16	
1897387	WELDTEC 235mm/20T	Handheld	Corded	235	20	30	20	2.4	ATB	49.41	59.29	
1897388	WELDTEC 235mm/40T	Handheld	Corded	235	40	30	20	2.4	ATB	55.97	67.16	
1897389	WELDTEC 235mm/60T	Handheld	Corded	235	60	30	20	2.4	ATB	69.86	83.83	
1897390	WELDTEC 136mm/18T	Handheld	Cordless	136	18	10	NO	1.8	ATB	18.29	21.95	
1897391	WELDTEC 136mm/24T	Handheld	Cordless	136	24	10	NO	1.8	ATB	20.36	24.43	
1897392	WELDTEC 165mm/18T	Handheld	Cordless	165	18	20	16	1.8	ATB	18.89	22.67	
1897393	WELDTEC 165mm/24T	Handheld	Cordless	165	24	20	16	1.8	ATB	22.65	27.18	
1897394	WELDTEC 165mm/40T	Handheld	Cordless	165	40	20	16	1.8	ATB	33.41	40.09	

CIRCULAR SAW BLADES

HAND HELD CONSTRUCTION

1. EXPANSION SLOTS

To dissipate heat and prevent warping

2. CONSTRUCTION GRADE CARBIDE TIPS

Retain their edge

3. FULLY HARDENED PLATE

4. ALTERNATE TOP BEVEL TOOTH GRIND (ATB)

For cross cutting and ripping in all woods

5. CORROSION RESISTANT COATING

For longer quality performance



HAND HELD CONSTRUCTION

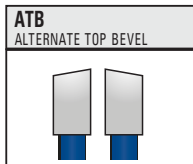

Item No.	Product Description	Category	Category	Diameter	Tooth Count	Arbor/Bore	Reductions	Kerf Thickness	Tooth Config.	LP Ex VAT \$ / Item	RRP Inc VAT \$ / Item	DISC. CODE
1897086	125mm/16T	Handheld	Corded	125	16	20	16	2.5	ATB	16.74	20.09	
1897087	130mm/20T	Handheld	Corded	130	20	20	16	2.5	ATB	17.54	21.05	
1897088	140mm/20T	Handheld	Corded	140	20	20	16	2.5	ATB	18.72	22.46	
1897089	150mm/18T	Handheld	Corded	150	18	20	16	2.5	ATB	17.85	21.42	
1897090	150mm/30T	Handheld	Corded	150	30	20	16	2.5	ATB	21.57	25.88	
1897191	160mm/18T	Handheld	Corded	160	18	20	16	2.5	ATB	18.41	22.09	
1897192	160mm/30T	Handheld	Corded	160	30	20	16	2.5	ATB	21.59	25.91	
1907698	160mm/24T	Handheld	Corded	160	24	30	20,16	2.5	ATB	20.80	24.96	
1897193	165mm/18T	Handheld	Corded	165	18	30	20,16	2.5	ATB	19.55	23.46	
1897194	165mm/30T	Handheld	Corded	165	30	30	20,16	2.5	ATB	24.58	29.50	
1897195	180mm/24T	Handheld	Corded	180	24	30	20,16	2.5	ATB	21.03	25.24	
1897196	180mm/36T	Handheld	Corded	180	36	30	20,16	2.5	ATB	26.80	32.16	
1907699	184mm/24T	Handheld	Corded	184	24	16	NO	2.5	ATB	19.11	22.93	
1897197	184mm/24T	Handheld	Corded	184	24	30	20,16	2.5	ATB	21.04	25.25	
1897198	184mm/40T	Handheld	Corded	184	40	30	20,16	2.5	ATB	30.41	36.49	
1897199	190mm/24T	Handheld	Corded	190	24	30	20,16	2.5	ATB	22.34	26.81	
1897200	190mm/40T	Handheld	Corded	190	40	30	20,16	2.5	ATB	33.36	40.03	
1897201	200mm/24T	Handheld	Corded	200	24	30	20,16	2.5	ATB	23.05	27.66	
1897202	200mm/40T	Handheld	Corded	200	40	30	20,16	2.5	ATB	34.55	41.46	
1897203	210mm/20T	Handheld	Corded	210	20	30	20,16	2.5	ATB	23.62	28.34	
1897204	210mm/40T	Handheld	Corded	210	40	30	20,16	2.5	ATB	35.95	43.14	
1897205	230mm/24T	Handheld	Corded	230	24	30	20,16	2.8	ATB	31.17	37.40	
1897206	230mm/40T	Handheld	Corded	230	40	30	20,16	2.8	ATB	42.10	50.52	
1897207	235mm/20T	Handheld	Corded	235	20	30	20,16	2.8	ATB	30.59	36.71	
1897208	235mm/40T	Handheld	Corded	235	40	30	20,16	2.8	ATB	42.53	51.04	

PTA B

HAND HELD NON-FERROUS METAL

1. EXPANSION SLOTS

Help keep the blade flat

2. TRIPLE CHIP GROUND TOOTH (TCG)

For excellent finish of the cut

3. SPECIALLY DESIGNED

For cutting all types of non-ferrous metals such as aluminium, copper, lead and plastics

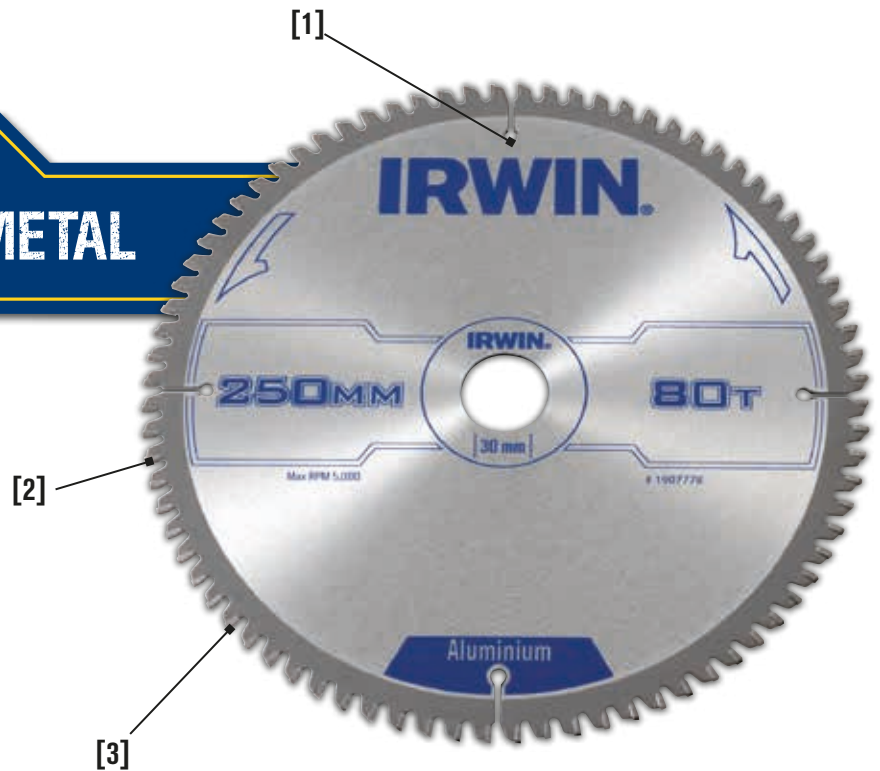

NON-FERROUS METAL

Item No.	Product Description	Category	Category	Diameter	Tooth Count	Arbor/Bore	Reductions	Kerf Thickness	Tooth Config.	LP Ex VAT £ / Item	RRP Inc VAT £ / Item	DISC CODE
1907772	Aluminium 160 x 56 x 20	Speciality	Speciality	160	56	20	16	2.5	TCG	40.35	48.42	IPTA B
1907773	Aluminium 184 x 48 x 30	Speciality	Speciality	184	48	30	25/20/16	2.5	TCG	36.53	43.84	
1907774	Aluminium 200 x 60 x 30	Speciality	Speciality	200	60	30	NO	2.5	TCG	50.60	60.72	
1907775	Aluminium 210 x 60 x 30	Speciality	Speciality	210	60	30	NO	2.5	TCG	51.76	62.11	
1907777	Aluminium 216 x 60 x 30	Speciality	Speciality	216	60	30	NO	2.5	TCG	52.15	62.58	
1907778	Aluminium 250 x 80 x 30	Speciality	Speciality	250	80	30	20/16	2.5	TCG	59.00	70.80	
1907779	Aluminium 250 x 100 x 30	Speciality	Speciality	250	100	30	20/16	2.5	TCG	67.88	81.46	
1907781	Aluminium 300 x 96 x 30	Speciality	Speciality	300	96	30	1-1/8"/20/16	2.5	TCG	118.95	142.74	
1907782	Aluminium 350 x 84 x 30	Speciality	Speciality	350	84	30	NO	2.5	TCG	121.85	146.22	

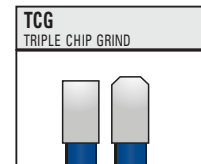



LONG ESTABLISHED MANUFACTURING EXCELLENCE LEADS TO PERFECTION

IRWIN® manufactures and distributes high quality cutting tools for trade professionals who demand superior performance and durability on the job.

Our engineers have been working for almost a century on constant product improvement, resulting in a state-of-the-art in-house electron beam welding process to create the highest quality bi-metal blades that out-perform the competition, stay sharper and last longer.



The WeldTec™ platform combines various attributes to deliver long lasting cutting performance. A revolutionary tooth geometry and an updated tooth set enables faster and smoother cuts, as well as improved longevity

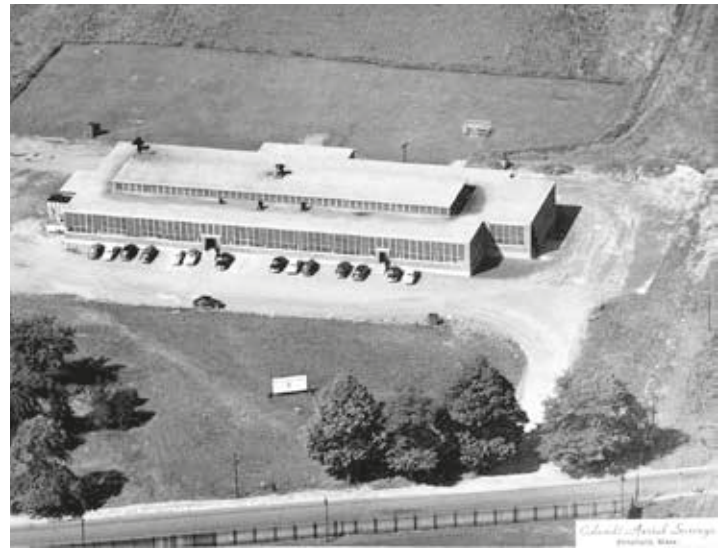

HOLE SAWS



RECIPROCATING BLADES



JIGSAW BLADES



BI-METAL HOLE SAWS

IRWIN® Bi-Metal Hole Saws cut through a variety of materials, including: Aluminium, Copper, Iron, Stainless Steel, Wood and Zinc. Electron Beam welded HSS cutting edge for stronger, longer lasting teeth. Precision Set Teeth for faster penetration and cutting. Bi-Metal Construction for toughness and long life.

WITH **WELDTEC™**

BI-METAL HOLE SAWS

1. WELDTEC™ TECHNOLOGY

Delivers enhanced durability and higher cutting speed.

2. 4,5 / 5,5 VARIABLE TPI

Faster cuts, less torque build-up and enhanced chip removal.

3. VARIABLE GULLET DEPTHS

For more efficient chip clearance.

4. THICK BACKING PLATE

Gives robustness for the toughest jobs.

4. BI-METAL CONSTRUCTION

For long life and shock resistance.

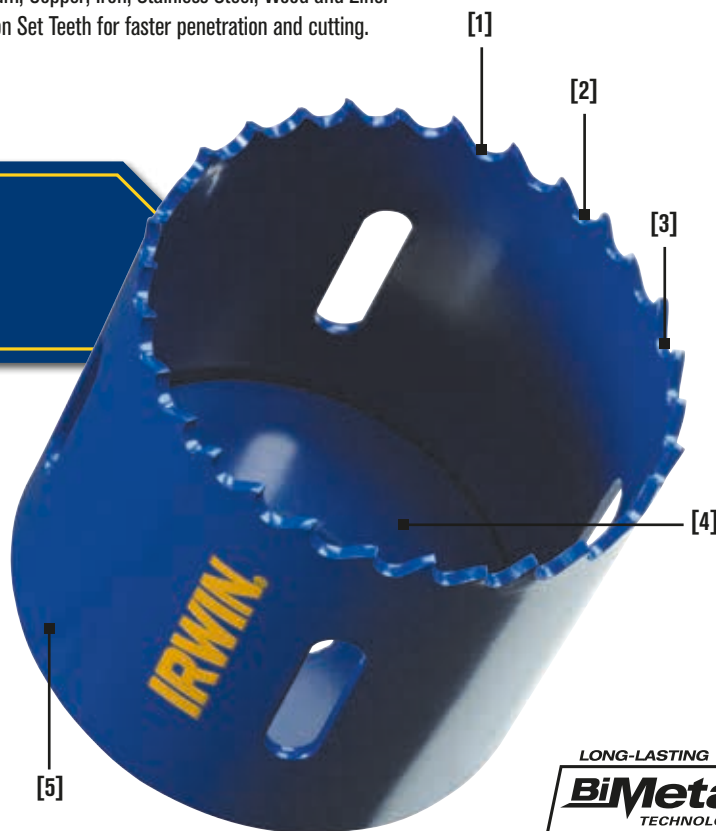

NEW TOOTH DESIGN

Up to 100% longer life*

Up to 50% faster cutting*

*vs. previous model

Item No.	Holesaw Diameter	EAN	Master Pack	Shelf Pack	LP Ex VAT £ / Item	RRP Inc VAT £ / Item	DISC. CODE
10504161	Ø 14mm	5706915041613	160	1	8.26	9.91	PTA B
10504162	Ø 16mm	5706915041620	160	1	6.49	7.79	
10504163	Ø 17mm	5706915041637	160	1	6.49	7.79	
10504164	Ø 19mm	5706915041644	160	1	6.49	7.79	
10504165	Ø 20mm	5706915041651	160	1	6.49	7.79	
10504166	Ø 21mm	5706915041668	160	1	6.49	7.79	
10504167	Ø 22mm	5706915041675	160	1	6.71	8.05	
10504168	Ø 24mm	5706915041682	160	1	7.18	8.62	
10504169	Ø 25mm	5706915041699	160	1	8.33	10.00	
10504170	Ø 27mm	5706915041705	160	1	8.50	10.20	
10504171	Ø 29mm	5706915041712	160	1	8.97	10.76	
10504172	Ø 30mm	5706915041729	160	1	9.74	11.69	
10504173	Ø 32mm	5706915041736	120	1	9.74	11.69	
10504174	Ø 33mm	5706915041743	120	1	9.95	11.94	
10504175	Ø 35mm	5706915041750	120	1	10.88	13.06	
10504176	Ø 37mm	5706915041767	120	1	10.88	13.06	
10504177	Ø 38mm	5706915041774	120	1	10.88	13.06	
10504178	Ø 40mm	5706915041781	120	1	11.32	13.58	
10504179	Ø 41mm	5706915041798	120	1	11.39	13.67	
10504180	Ø 43mm	5706915041804	120	1	11.82	14.18	
10504181	Ø 44mm	5706915041811	120	1	11.82	14.18	
10504182	Ø 46mm	5706915041828	120	1	11.82	14.18	
10504183	Ø 48mm	5706915041835	100	1	11.82	14.18	
10504184	Ø 51mm	5706915041842	100	1	11.82	14.18	
10504185	Ø 52mm	5706915041859	100	1	12.78	15.34	
10504186	Ø 54mm	5706915041866	100	1	13.16	15.79	
10507366	Ø 56mm	5706915073669	100	1	12.33	14.80	
10504187	Ø 57mm	5706915041873	100	1	13.58	16.30	
10504188	Ø 59mm	5706915041880	100	1	14.14	16.97	
10504189	Ø 60mm	5706915041897	100	1	14.14	16.97	

BI-METAL HOLE SAWS

Item No.	Holesaw Diameter	EAN	Master Pack	Shelf Pack	LP Ex VAT £ / Item	RRP Inc VAT £ / Item	DISC. CODE
10507367	Ø 62mm	5706915073676	100	1	13.34	16.01	PTA B
10504190	Ø 64mm	5706915041903	50	1	14.14	16.97	
10504191	Ø 65mm	5706915041910	50	1	14.14	16.97	
10504192	Ø 67mm	5706915041927	50	1	14.14	16.97	
10504193	Ø 68mm	5706915041934	50	1	14.14	16.97	
10504194	Ø 70mm	5706915041941	50	1	14.65	17.58	
10504195	Ø 73mm	5706915041958	50	1	15.10	18.12	
10504196	Ø 76mm	5706915041965	50	1	15.20	18.24	
10504197	Ø 79mm	5706915041972	50	1	15.82	18.98	
10504198	Ø 83mm	5706915041989	50	1	16.00	19.20	
10504199	Ø 86mm	5706915041996	50	1	16.94	20.33	
10504200	Ø 89mm	5706915042009	50	1	17.42	20.90	
10504201	Ø 92mm	5706915042016	40	1	18.10	21.72	
10504202	Ø 95mm	5706915042023	40	1	19.22	23.06	
10504203	Ø 98mm	5706915042030	40	1	20.65	24.78	
10504204	Ø 102mm	5706915042047	40	1	21.95	26.34	
10504205	Ø 105mm	5706915042054	40	1	22.90	27.48	
10504206	Ø 108mm	5706915042061	40	1	28.07	33.68	
10504207	Ø 111mm	5706915042078	40	1	30.47	36.56	
10504208	Ø 114mm	5706915042085	40	1	31.73	38.08	
10504209	Ø 117mm	5706915042092	20	1	34.61	41.53	
10504210	Ø 121mm	5706915042108	20	1	36.16	43.39	
10504211	Ø 127mm	5706915042115	20	1	44.09	52.91	
10505818	Ø 133mm	5706915058185	20	1	41.35	49.62	
10504212	Ø 140mm	5706915042122	20	1	45.80	54.96	
10504213	Ø 152mm	5706915042139	20	1	52.24	62.69	
10505819	Ø 168mm	5706915058192	20	1	105.70	126.84	
10505820	Ø 177mm	5706915058208	20	1	110.29	132.35	
10505821	Ø 210mm	5706915058215	20	1	114.89	137.87	



HOLE SAWS

MANDRELS / PILOT DRILL BITS FOR BI-METAL HOLE SAWS

Item No.	Description	EAN	Master Pack	Shelf Pack	LP Ex VAT £ / Item	RRP Inc VAT £ / Item	DISC. CODE
10504532	Pilot Drill	5706915945324	20	1	3.84	4.61	PTA B
10504536	Mandrel 9,5mm chuck diameter, fits Hole Saws 14 - 30mm	5706915945362	20	1	9.11	10.93	
10504533	Mandrel 13mm chuck diameter, fits Hole Saws 14 - 30mm	5706915945331	20	1	9.68	11.62	
10504534	Mandrel 9,5mm chuck diameter, fits Hole Saws 32 - 210mm	5706915945348	20	1	14.41	17.29	
10504535	Mandrel 13mm chuck diameter, fits Hole Saws 32 - 210mm	5706915945355	20	1	15.40	18.48	
10507368	Extension Rod, 300mm, Chuck size 13+mm	5706915073683	20	1	12.43	14.92	



BI-METAL HOLE SAW KITS

IRWIN® Hole Saw Kits are now available in a unique attractive soft storage case that incorporates an unbreakable hinge and internal padding that protects the contents. The case has an integral handle and has a cardboard sleeve that contains important product information.

Item No.	Description	EAN	Master Pack	Shelf Pack	LP Ex VAT £ / Item	RRP Inc VAT £ / Item	DISC. CODE
10507235	Hole Saw Kit 400SE: 22, 35, 65, 67mm, Arbors 10504535 & 10504536, Pilot drill	5706915072358	144	1	91.45	109.74	PTA B
10506439	Hole Saw Kit 600L: 22, 29, 35, 44, 51, 64mm, Arbors 10504535 & 10504536, Pilot drill	5706915064391	144	1	79.90	95.88	
10506440	Hole Saw Kit 600L SE: 22, 29, 35, 44, 51, 65mm, Arbors 10504535 & 10504536, Pilot drill	5706915064407	144	1	79.90	95.88	
10506441	Hole Saw Kit INT600L: 16, 20, 25, 32, 38, 51mm, Arbors 10504535 & 10504536, Pilot drill	5706915064414	144	1	71.87	86.24	
10506442	Hole Saw Kit 600P: 19, 22, 29, 38, 44, 57mm, Arbors 10504535 & 10504536, Pilot drill	5706915064421	144	1	76.15	91.38	
10506444	Hole Saw Kit 1200G: 16, 19, 22, 25, 29, 32, 35, 38, 44, 51, 64, 76mm, Arbors 10504533 & 10504535, 3 Pilot drills	5706915064445	96	1	135.93	163.12	
10506445	Hole Saw Kit 1200G SE: 16, 19, 22, 25, 29, 32, 35, 38, 44, 51, 65, 76mm, Arbors 10504533 & 10504535, 3 Pilot drills	5706915064452	96	1	135.93	163.12	





RECIPROCATING SAW BLADES

This comprehensive reciprocating saw blade offering has a blade for every application. IRWIN® blades offer superior construction & design making them faster cutting and longer lasting, therefore giving the user a superior cost-per-cut value.

BI-METAL RECIPROCATING BLADES

1. **INCREASED TANG ANGLE**
For up to 50% faster cuts vs prior model.
2. **BI-METAL CONSTRUCTION**
For a faster cutting, longer lasting blade that can bend without breaking.
3. **8% COBALT**
Keeps teeth sharper, longer.
4. **ELECTRON BEAM WELD**
For stronger, longer lasting teeth.



Improved tooth configuration
Faster Cut: Up to 50% faster vs. prior model
Available in: 10, 14, 18 and 24TPI on metal cutting reciprocating saws
Cuts all metals including non ferrous, pipe conduit, stainless & sheet metal
Suitable for use with materials 1.5 to 10mm (1/16" to 3/8") thick, dependent on the TPI of the blade

RECIPROCATING BLADES

METAL CUTTING BI-METAL RECIPROCATING BLADES

Item No.	Description	Blades per Pack	EAN	Master Pack	Shelf Pack	LP Ex VAT £ / Item	RRP inc VAT £ / Item	DISC. CODE
10506424	614R 150mm 14TPI, Metal Cutting	2	5706915064247	150	1	5.03	6.04	PTAB
10506425	624R 150mm 24TPI, Metal Cutting	2	5706915064254	150	1	5.07	6.08	
10506426	818R 200mm 18TPI, Metal Cutting	2	5706915064261	90	1	6.33	7.60	
10504147	414R 100mm 14TPI, Metal Cutting	5	5706915041477	100	1	8.76	10.51	
10504148	418R 100mm 18TPI, Metal Cutting	5	5706915041484	100	1	8.64	10.37	
10504152	614R 150mm 14TPI, Metal Cutting	5	5706915041521	100	1	11.17	13.40	
10504153	618R 150mm 18TPI, Metal Cutting	5	5706915041538	100	1	11.21	13.45	
10504154	624R 150mm 24TPI, Metal Cutting	5	5706915041545	100	1	11.22	13.46	
10504156	818R 200mm 18TPI, Metal Cutting	5	5706915041569	50	1	13.98	16.78	
10504143	614R 150mm 14TPI, Metal Cutting	25	5706915041439	20	1	51.74	62.09	
10504140	818R 200mm 18TPI, Metal Cutting	25	5706915041408	10	1	65.49	78.59	

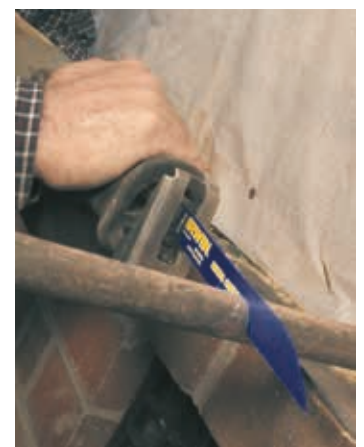



Cuts composition materials such as plastic, wood, pipe, carbon steel & stainless steel
Suitable for use with materials 3.2mm (1/8") & thicker
Available in 10 TPI in 150, 200 & 300mm (6", 8" & 12") sizes

METAL & WOOD CUTTING BI-METAL RECIPROCATING BLADES



Item No.	Description	Blades per Pack	EAN	Master Pack	Shelf Pack	LP Ex VAT £ / Item	RRP Inc VAT £ / Item	DISC. CODE
10506427	610R 150mm 10TPI, Metal & Wood Cutting	2	5706915064278	150	1	5.03	6.04	PTA B
10506428	810R 200mm 10TPI, Metal & Wood Cutting	2	5706915064285	90	1	6.33	7.60	
10504151	610R 150mm 10TPI, Metal & Wood Cutting	5	5706915041514	100	1	11.17	13.40	
10504157	810R 200mm 10TPI, Metal & Wood Cutting	5	5706915041576	50	1	13.98	16.78	
10504159	110R 300mm 10TPI, Metal & Wood Cutting	5	5706915041590	50	1	21.28	25.54	
10504141	810R 200mm 10TPI, Metal & Wood Cutting	25	5706915041415	10	1	66.31	79.57	
10504142	110R 300mm 10TPI, Metal & Wood Cutting	25	5706915041422	25	1	99.91	119.89	

NAIL-EMBEDDED BI-METAL RECIPROCATING BLADES



Cuts nail embedded wood
Suitable for use with materials 5mm (3/16") & thicker
Available in 6 TPI in 150, 225 & 300mm (6", 9" & 12") sizes

Item No.	Description	Blades per Pack	EAN	Master Pack	Shelf Pack	LP Ex VAT £ / Item	RRP Inc VAT £ / Item	DISC. CODE
10506429	656R 150mm 6TPI, Nail-Embedded Wood Cutting	2	5706915064292	150	1	5.75	6.90	PTA B
10506430	956R 225mm 6TPI, Nail-Embedded Wood Cutting	2	5706915064308	90	1	7.59	9.11	
10504155	656R 150mm 6TPI, Nail-Embedded Wood Cutting	5	5706915041552	100	1	13.98	16.78	
10504158	956R 225mm 6TPI, Nail-Embedded Wood Cutting	5	5706915041583	50	1	16.78	20.14	
10504160	156R 300mm 6TPI, Nail-Embedded Wood Cutting	5	5706915041606	50	1	20.71	24.85	
10504146	656R 150mm 6TPI, Nail-Embedded Wood Cutting	25	5706915041460	20	1	59.14	70.97	
10504149	956R 225mm 6TPI, Nail-Embedded Wood Cutting	25	5706915041491	10	1	79.63	95.56	
10504144	156R 300mm 6TPI, Nail-Embedded Wood Cutting	25	5706915041446	10	1	96.82	116.18	

DEMOLITION BI-METAL RECIPROCATING BLADES



For use on heavy duty & demolition applications in wood & metal
Suitable for use with materials 5mm (3/16") & thicker
Available in 6 or 10 TPI in 225mm (9")

Item No.	Description	Blades per Pack	EAN	Master Pack	Shelf Pack	LP Ex VAT £ / Item	RRP Inc VAT £ / Item	DISC. CODE
10504138	966R 225mm 6TPI, Demolition Applications	5	5706915041385	50	1	27.31	32.77	PTA B
10504139	960R 225mm 10TPI, Demolition Applications	5	5706915041392	50	1	27.36	32.83	

WOOD CUTTING BI-METAL RECIPROCATING BLADES



For fast cutting wood
Suitable for use with materials 5mm (3/16") & thicker
Available in 6 TPI in 150mm (6")

Item No.	Description	Blades per Pack	EAN	Master Pack	Shelf Pack	LP Ex VAT £ / Item	RRP Inc VAT £ / Item	DISC. CODE
10504150	606R 150mm 6TPI, Wood Cutting	5	5706915041507	100	1	10.72	12.86	PTA B

MASTER-GRIT RECIPROCATING BLADES



Item No.	Description	Blades per Pack	EAN	Master Pack	Shelf Pack	LP Ex VAT £ / Item	RRP Inc VAT £ / Item	DISC. CODE
10507365	800RG, 200mm GRIT, Abrasive Applications	2	5706915073652	80	1	12.52	15.02	PTA B

Carbide Grit Edge Material

Problem solver to cut cast iron, fibreglass, plaster, marble or similar abrasive materials.

WOOD, COMPOSITION MATERIAL & PLASTIC CUTTING HCS RECIPROCATING BLADES



Item No.	Description	Blades per Pack	EAN	Master Pack	Shelf Pack	LP Ex VAT £ / Item	RRP Inc VAT £ / Item	DISC. CODE
10506431	S617K, HCS, 150mm 3TPI, Wood Cutting	2	5706915064315	100	1	6.07	7.28	PTA B
10506432	S2345X, HCS, 200mm PROG 4/2.4 TPI, Wood Cutting	2	5706915064322	100	1	10.14	12.17	
10505812	S617K, HCS, 150mm, 3TPI, Wood Cutting	5	5706915058123	50	1	13.09	15.71	
10505813	S1131L, HCS, 225mm, 5TPI, Wood Cutting	5	5706915058130	50	1	18.30	21.96	
10505814	S2345X, HCS, 200mm PROG 4/2.4TPI, Wood Cutting	5	5706915058147	50	1	21.05	25.26	

For fast cutting wood composition material & plastic

Range of regular (10505812 and 10505813) and progressive teeth (10505814)

Available in 3 tooth configurations 3TPI / 5TPI & 4/2.4TPI

MASONRY RECIPROCATING BLADES



Item No.	Description	EAN	Master Pack	Shelf Pack	LP Ex VAT £ / Item	RRP Inc VAT £ / Item	DISC. CODE
10507846	MRB 235 x 20mm 2.5TPI, Masonry Cutting	5706915078466	25	1	27.88	33.46	PTA B
10507847	MRB 300 x 50mm 2.5TPI, Masonry Cutting	5706915078473	25	1	38.85	46.62	
10507848	MRB 450 x 50mm 2.5TPI, Masonry Cutting	5706915078480	25	1	54.77	65.72	

Fast, durable and precise cutting in many masonry materials like clay bricks, limestone or gas concrete.

Universal 1/2" shank



JIGSAW BLADES

This comprehensive jigsaw blade offering has a blade for every application. The range includes both T-shank and U-shank to fit all of today's most popular jigsaw power tool machines.

IRWIN® Jigsaw Blades are manufactured from the following high quality materials:

HCS Carbon steel for use in softer materials such as wood, laminated chipboard, and plastics.

HSS Fully hardened high-speed steel for use in metal, aluminium, and non-ferrous metal.

WOOD CUTTING HCS JIGSAW BLADES - T-SHANK



3 Sided, fleam ground teeth for fast cut and clean finishes

Fast and smooth cut in all wood applications

Item No.	Description	Blades per Pack	EAN	Master Pack	Shelf Pack	LP Ex VAT £ / Item	RRP Inc VAT £ / Item	DISC. CODE
10504218	HCS, 100mm, 6 TPI, T144D, Standard, Wood Cutting	5	5706915042184	100	1	7.01	8.41	PTA A
10504219	HCS, 100mm, 10 TPI, T101B, Side Ground, Wood Cutting	5	5706915042191	100	1	8.97	10.76	
10504221	HCS, 100mm, 8 TPI, T111C, Standard, Wood Cutting	5	5706915042214	100	1	4.65	5.58	
10504222	HCS, 100mm, 6 TPI, T101D, Side Ground, Wood Cutting	5	5706915042221	100	1	8.97	10.76	
10504223	HCS, 100mm, 10 TPI, T101BR, Side Ground Reverse, Wood Cutting	5	5706915042238	100	1	9.92	11.90	
10504224	HCS, 100mm, 6 TPI, T244D, Standard Contour, Wood Cutting	5	5706915042245	100	1	9.04	10.85	
10504226	HCS, 83mm, 20 TPI, T101AD, Side Ground Narrow Contour, Wood Cutting	5	5706915042269	100	1	17.19	20.63	
10504227	HCS, 83mm, 12 TPI, T119B0, Standard Narrow Contour, Wood Cutting	5	5706915042276	100	1	6.84	8.21	
10504228	HCS, 115mm, Progressive 8-13TPI, T234X, Side Ground, Wood Cutting	5	5706915042283	100	1	14.02	16.82	
10504229	HCS, 115mm, 8 TPI, T301CD, Side Ground, Wood Cutting	5	5706915042290	100	1	15.44	18.53	
10504410	HCS, 100mm, 6 TPI, T144DP, Standard Extra Thick 1.68mm, Wood Cutting	5	5706915044102	100	1	9.55	11.46	
10504545	HCS, 100mm, 6 TPI, T144D, Standard, Wood Cutting	100	5706915945454	10	1	140.15	168.18	

METAL CUTTING HSS JIGSAW BLADES - T-SHANK



HSS milled teeth for longer life and fast cuts in metal

Extended life for fast and even cuts in thin and thick metal

Item No.	Description	Blades per Pack	EAN	Master Pack	Shelf Pack	LP Ex VAT £ / Item	RRP Inc VAT £ / Item	DISC. CODE
10504220	HSS, 92mm, Progressive 17-23TPI, T118A, Metal Cutting	5	5706915042207	100	1	8.65	10.38	PTA A
10504225	HSS, 92mm, Progressive 11-13TPI, T118B, Metal Cutting	5	5706915042252	100	1	8.65	10.38	
10504234	HSS, 92mm, 36 TPI, T118G, Metal Cutting	5	5706915042344	100	1	8.65	10.38	
10504231	HSS, 100mm, 8 TPI, T127D, Metal Cutting	5	5706915042313	100	1	9.39	11.27	
10504233	HSS, 100mm, Progressive 10-20TPI, T123X, Metal Cutting	5	5706915042337	100	1	11.23	13.48	
10504230	HSS, 132mm, 24 TPI, T318A, Metal Cutting	5	5706915042306	100	1	19.66	23.59	

METAL & WOOD CUTTING BI-METAL JIGSAW BLADES - T-SHANK



Progressive Tooth form for all-purpose cutting in wood and metal

Bi-Metal progressive tooth blade for extended life in wood and metal

Item No.	Description	Blades per Pack	EAN	Master Pack	Shelf Pack	LP Ex VAT £ / Item	RRP Inc VAT £ / Item	DISC. CODE
10504232	BIM, 132mm, Progressive 5-10TPI, T345XF, Metal & Wood Cutting	5	5706915042320	100	1	16.83	20.20	PTA A

FIBER & PLASTER CARBIDE TIPPED JIGSAW BLADES - T-SHANK



Item No.	Description	Blades per Pack	EAN	Master Pack	Shelf Pack	LP Ex VAT £ / Item	RRP Inc VAT £ / Item	DISC CODE
10505815	T141HM Carbide Tipped, 100mm, 6TPI, Fiber & Plastic Cutting	1	5706915058154	100	1	10.35	12.42	PTA A
10505816	T341HM Carbide Tipped, 132mm, 6TPI	1	5706915058161	100	1	13.88	16.66	

Carbide tipped for long lifetime, especially for abrasive materials

METAL & WOOD CUTTING JIGSAW BLADES SET - T-SHANK

Item No.	Description	Blades per Pack	EAN	Master Pack	Shelf Pack	LP Ex VAT £ / Item	RRP Inc VAT £ / Item	DISC CODE
10505817	Jigsaw Set T-Shank: 2 x 10504221 Wood, 100mm, 8 TPI 2 x 10504218 Wood, 100mm, 6 TPI (fast cut) 2 x 10504219 Wood, 100mm, 10 TPI 1 x 10504222 Wood, 100mm, 6 TPI (clean cut) 2 x 10504220 Metal, 92mm, Progressive 17 - 23 TPI 1 x 10504225 Metal, 92mm, Progressive 11 - 13 TPI	10	5706915058178	50	1	11.40	13.68	PTA A



WOOD CUTTING HCS JIGSAW BLADES - U-SHANK



Item No.	Description	Blades per Pack	EAN	Master Pack	Shelf Pack	LP Ex VAT £ / Item	RRP Inc VAT £ / Item	DISC CODE
10504235	HCS, 100mm, 6 TPI, U144D, Standard, Wood Cutting	5	5706915042351	100	1	7.01	8.41	PTA A
10504288	HCS, 100mm, 10 TPI, U101B, Side Ground, Wood Cutting	5	5706915042887	100	1	8.97	10.76	
10504290	HCS, 100mm, 8 TPI, U111C, Standard, Wood Cutting	5	5706915042900	100	1	4.65	5.58	
10504291	HCS, 100mm, 6 TPI, U101D, Side Ground, Wood Cutting	5	5706915042917	100	1	8.97	10.76	
10504292	HCS, 100mm, 6 TPI, U244D, Standard Contour, Wood Cutting	5	5706915042924	100	1	9.04	10.85	
10504295	HCS, 115mm, Progressive 8-13TPI, U234X, Side Ground, Wood Cutting	5	5706915042955	100	1	14.02	16.82	

3 Sided, fleam ground teeth for fast cut and clean finishes
Fast and smooth cut in all wood applications

METAL CUTTING HSS JIGSAW BLADES - U-SHANK



Item No.	Description	Blades per Pack	EAN	Master Pack	Shelf Pack	LP Ex VAT £ / Item	RRP Inc VAT £ / Item	DISC CODE
10504289	HSS, 70mm, 24 TPI, U118A, Metal Cutting	5	5706915042894	100	1	8.65	10.38	PTA A
10504293	HSS, 70mm, 12 TPI, U118B, Metal Cutting	5	5706915042931	100	1	8.65	10.38	
10504294	HSS, 70mm, 36 TPI, U118G, Metal Cutting	5	5706915042948	100	1	8.65	10.38	
10504297	HSS, 100mm, Progressive 10-20TPI, U123X, Metal Cutting	5	5706915042979	100	1	11.23	13.48	

HSS milled teeth for longer life and fast cuts in metal
Extended life for fast and even cuts in thin and thick metal

METAL & WOOD CUTTING BI-METAL JIGSAW BLADES - U-SHANK



Item No.	Description	Blades per Pack	EAN	Master Pack	Shelf Pack	LP Ex VAT £ / Item	RRP Inc VAT £ / Item	DISC CODE
10504296	BIM, 132mm, Progressive 5-10TPI, U345XF, Metal & Wood Cutting	5	5706915042962	100	1	16.83	20.20	PTA A



Progressive Tooth form for all-purpose cutting in wood and metal
Bi-Metal progressive tooth blade for extended life in wood and metal

ITEM NO.	PAGE	ITEM NO.	PAGE	ITEM NO.	PAGE	ITEM NO.	PAGE	ITEM NO.	PAGE	ITEM NO.	PAGE	ITEM NO.	PAGE	ITEM NO.	PAGE
1ZR	54	1868267	113	1897428	145	1921995	120	1923407	126	10501839	97	10501931	96	10502010	91
2	8	1868268	113	1897429	145	1921996	120	1923408	126	10501841	97	10501932	96	10502011	91
3	54	1868269	113	1897430	145	1921997	120	1923409	126	10501846	97	10501933	96	10502012	91
4	8	1868270	113	1897431	145	1921998	120	1923410	126	10501847	97	10501934	96	10502013	91
4ZR	54	1868271	113	1897432	145	1921999	120	1923411	126	10501848	97	10501935	96	10502014	91
5	54	1868272	113	1897433	145	1922000	120	1923412	126	10501849	97	10501936	96	10502015	91
6	54	1888437	62	1897434	145	1922001	120	1923413	127	10501850	97	10501937	96	10502016	91
8	8	1888438	62	1897435	145	1922002	120	1923414	127	10501851	97	10501938	137	10502017	91
8ZR	54	1888439	62	1897436	145	1922003	120	1923415	127	10501853	97	10501939	137	10502018	91
12L3	8	1897086	148	1897437	145	1922004	120	1923416	128	10501854	97	10501940	137	10502019	91
23	8	1897087	148	1897438	145	1922005	120	1923417	128	10501855	97	10501941	90	10502020	91
23ZR	53	1897088	148	1897439	145	1922006	120	1923418	128	10501856	97	10501942	90	10502021	91
25ZR	8	1897089	148	1897440	145	1922006	141	1923419	128	10501857	97	10501943	90	10502022	91
27ZR	9	1897090	148	1897441	145	1922007	120	1923420	128	10501859	97	10501944	90	10502023	91
29	8	1897191	148	1897442	145	1922007	141	1923431	128	10501861	97	10501945	90	10502024	91
40EXT	9	1897192	148	1897443	145	1923227	126	1923432	128	10501862	97	10501946	90	10502025	91
40REP	9	1897193	148	1897444	145	1923228	127	1923433	128	10501863	97	10501947	90	10502027	91
84C	57	1897194	148	1897445	145	1923229	127	1923434	128	10501864	97	10501948	90	10502028	91
112	53	1897195	148	1897446	145	1923286	127	1923435	128	10501865	97	10501949	90	10502029	91
114ZR	53	1897196	148	1897447	145	1923287	127	1923436	129	10501866	97	10501950	90	10502030	91
251	8	1897197	148	1897448	145	1923289	127	1923437	129	10501867	97	10501951	90	10502031	91
4008	9	1897198	148	1897449	145	1923290	127	1923501	127	10501868	97	10501952	90	10502033	91
4022ZR	9	1897199	148	1897450	145	1923321	127	1923502	127	10501869	97	10501953	90	10502035	91
4052ZR	9	1897200	148	1897451	145	1923322	127	2031333	70	10501870	97	10501954	90	10502036	91
4092	9	1897201	148	1897452	145	1923323	127	2071910	9	10501873	97	10501955	90	10502038	91
54125	134	1897202	148	1897453	144	1923326	127	2078116	13	10501874	97	10501956	90	10502040	91
64550	70	1897203	148	1897454	144	1923328	127	2078120	13	10501875	97	10501957	90	10502041	91
64610	70	1897204	148	1897455	144	1923330	127	3057011DS	141	10501878	97	10501958	90	10502042	91
64801ZR	70	1897205	148	1897456	144	1923331	127	3057013DS	141	10501879	97	10501959	90	10502043	91
64802	70	1897206	148	1897457	144	1923332	127	4935097	13	10501880	97	10501960	90	10502044	91
64901	70	1897207	148	1897458	144	1923333	127	4935309	9	10501881	97	10501961	90	10502046	91
64902	70	1897208	148	1897459	144	1923334	127	4935505	54	10501882	97	10501962	90	10502047	91
65201	70	1897209	145	1897460	144	1923335	127	10501671	37	10501884	97	10501963	90	10502048	91
66300	70	1897210	145	1897461	144	1923337	127	10501673	37	10501885	97	10501964	90	10502049	91
66305SL	70	1897211	145	1897462	144	1923338	127	10501675	37	10501886	97	10501965	90	10502050	91
66401ZR	70	1897212	145	1897463	144	1923339	127	10501677	37	10501892	137	10501966	90	10502052	91
66404	70	1897213	145	1897464	144	1923340	127	10501680	37	10501893	137	10501967	90	10502053	91
66406	70	1897214	145	1897465	144	1923342	127	10501682	37	10501894	98	10501968	90	10502054	91
233250	70	1897215	145	1897466	144	1923344	127	10501685	37	10501895	98	10501969	90	10502056	91
394100	134	1897346	145	1897467	144	1923346	127	10501689	37	10501896	98	10501970	90	10502057	91
666012	70	1897347	145	1897468	144	1923348	127	10501691	37	10501897	98	10501971	90	10502059	91
666042	70	1897348	145	1897469	144	1923350	127	10501693	37	10501898	98	10501972	90	10502060	91
666062	70	1897349	147	1897470	144	1923352	127	10501698	38	10501899	98	10501973	90	10502061	91
1826576	44	1897350	147	1897471	144	1923353	127	10501700	38	10501900	98	10501974	90	10502069	91
1826577	45	1897361	147	1897472	144	1923354	127	10501702	38	10501901	98	10501975	90	10502070	91
1826578	46	1897362	147	1897473	144	1923355	127	10501705	38	10501902	98	10501976	90	10502071	92
1826579	46	1897363	147	1897474	144	1923356	127	10501706	38	10501903	98	10501978	90	10502072	92
1840465	141	1897364	147	1897475	144	1923357	127	10501708	38	10501904	98	10501979	90	10502073	92
1863343	109	1897365	147	1897476	144	1923358	127	10501768	37	10501905	98	10501980	90	10502074	92
1863344	109	1897366	147	1897477	144	1923359	127	10501812	97	10501906	98	10501981	90	10502075	92
1863345	109	1897368	147	1897478	144	1923360	127	10501813	97	10501907	98	10501982	90	10502076	92
1863346	109	1897369	147	1897479	144	1923361	127	10501814	97	10501908	98	10501984	90	10502077	92
1863347	112	1897370	147	1897480	144	1923362	127	10501815	97	10501910	98	10501985	90	10502080	92
1863348	112	1897381	147	1897525	33	1923364	127	10501816	97	10501911	98	10501986	90	10502082	92
1863349	112	1897382	147	1897526	32	1923366	127	10501817	97	10501912	98	10501987	90	10502083	92
1863350	112	1897383	147	1907698	148	1923368	127	10501818	97	10501913	98	10501988	90	10502084	92
1863361	112	1897384	147	1907699	148	1923370	127	10501819	97	10501914	98	10501989	90	10502085	92
1863362	112	1897385	147	1907700	145	1923372	126	10501820	97	10501915	98	10501991	90	10502086	92
1868193	132	1897386	147	1907772	149	1923373	126	10501821	97	10501916	98	10501992	90	10502087	92
1868194	132	1897387	147	1907773	149	1923375	126	10501822	97	10501917	137	10501993	90	10502088	92
1868195	132	1897388	147	1907774	149	1923376	126	10501823	97	10501918	137	10501994	90	10502089	136
1868196	132	1897389	147	1907775	149	1923377	126	10501824	97	10501919	96	10501995	90	10502092	93
1868197	132	1897390	147	1907777	149	1923378	126	10501825	97	10501920	96	10501996	90	10502093	93
1868198	132	1897391	147	1907778	149	1923381	126	10501826	97	10501921	96	10501997	90	10502094	93
1868199	132	1897392	147	1907779	149	1923383	126	10501827	97	10501922	96	10501998	90	10502095	93
1868200	132	1897393	147	1907781	149	1923385	126	10501829	97	10501923	96	10501999	90	10502096	93
1868251	133	1897394	147	1907782	149	1923386	126	10501830	97	10501924	96	10502000	90	10502097	93
1868252	133	1897395	145	1910231	15	1923387	126	10501831	97	10501925	96	10502002	90	10502098	93
1868262	112	1897396	145	1921930	120	1923388	126	10501834	97	10501926	96	10502004	90	10502099	93
1868263	112	1897397	145	1921991	120	1923391	126	10501835	97	10501927	96	10502005	90	10502100	93
1868264	112	1897398	145	1921992	120	1923392	126	10501836	97	10501928	96	10502006	90	10502101	93
1868265	112	1897426	145	1921993	120	1923405	126	10501837	97	10501929	96	10502007	90	10502102	93
1868266	112	1897427	145	1921994	120	1923406	126	10501838	97	10501930	96	10502008	91	10502103	93

Catalogue Index

ITEM NO.	PAGE	ITEM NO.	PAGE	ITEM NO.	PAGE	ITEM NO.	PAGE	ITEM NO.	PAGE	ITEM NO.	PAGE	ITEM NO.	PAGE	ITEM NO.	PAGE
10508018	6	T17EL4	7	T182CB	58	T1353	50	T35010E	20	T563217	82	TF3M3467	82	TMFC153	50
10508019	6	T18DR	7	T182CC	58	T1354	50	T35012	20	T563218	82	TG3A1521	83	TMR2049	40
10508020	9	T18EL4	8	T182CD	58	T1355	50	T35014	20	T563218	82	TG3A2156	83	TMR2210	40
10508052	67	T18R	7	T183C	56	T1356	50	T35018	20	T563219	82	TG3A2832	83	TMR22086	40
10508053	67	T18SP	8	T183CA	58	T1357	50	T35018A	20	T563251	82	TG56	28	TMR22089	40
10508054	67	T19EL4	7	T183CB	58	T1359	50	T35018C	20	T563251	82	TG056	28	TNA2059343000	35
10508056	67	T20EL4	8	T183CC	58	T1365	50	T35024	20	T563251	82	TG67	28	TNA2072330000	35
10508057	67	T23C	57	T183CD	58	T1366	50	T35024A	20	T563252	82	TG69	28	TSI2	41
10508059	67	T23DK	57	T202	78	T1367	50	T35024C	20	T563252	82	TG69NB	28	TSI238	41
10508060	67	T23L	57	T202DF	78	T1369	50	T35036	20	T563252	82	TG245S8	28	TSP4	41
10508103	64	T23O	57	T202EF	78	T1402EL4	7	T35036A	20	T563342	83	TG245S10	28	TSP5	41
10508104	63	T24R	7	T210	78	T1502EL4	7	T35036C	20	T563400	82	TG245S12	28	TTBC914	26
10508105	63	T24SP	8	T214T	9	T1602EL4	7	T35048	20	T563401	82	TG245S14	28	TTBC918	26
10508107	61	T25	53	T0220D	41	T3008	19	T35048A	20	T563401	82	TG691	28	TTBC924	26
10508108	61	T25C	57	T220D	79	T3508	20	T35048C	20	T563402	82	TG950	28	TTBC930	26
10508110	61	T25DK	57	T220H	79	T5212ED	55	T5006EL7	46	T563402	82	TG2458	28	TTBC936	26
10508135	65	T25L	57	T223B	79	T5212EDA	58	T58100EL7	46	T563403	82	TG2468	28	TTS10	56
10508136	65	T25O	57	T223J	79	T5212EDC	58	T58200EL7	46	T563404	82	TG24510	28	TUL223	79
10508151	15	T36	53	T233C	20	T5212EDD	58	T58300EL7	46	T563406	82	TG24512	28	TV75B	55
10508152	15	T36C	57	T233CDB	20	T5212EDJN	58	T59100ECD	46	T563409	83	TG24514	28	TV149B	55
10508153	15	T36DK	57	T234C	20	T5212EDO	58	T59200ECD	46	T563409	83	TG24610	28	TV150B	55
10508154	15	T36L	57	T234CDB	20	T5212PD	55	T59400ECD	46	T563411	83	TG24612	28	TV175B	55
10508155	15	T36O	57	T235C	20	T5212PDC	58	T090700	79	T563412	83	THPC022	78	TWC6	27
10508156	16	T52ED	55	T235CDB	20	T5212PDO	58	T090700B	79	T563413	83	TJ914F	27	TWC16	27
10508157	16	T52EDA	58	T240	20	T5412EL7	46	T090751	79	T591020	82	TJ914H	27	TXP1120762000	34
10508158	16	T52EDC	58	T0302EL4	7	T06012	41	T090757	79	T591022	82	TJ918F	27	TXP1124610000	34
10508159	16	T52EDD	58	T414	56	T7250	35	T090757	79	T591023	82	TJ918H	27	TXP1124762000	34
10508160	16	T52EDJN	58	T0502EL4	7	T8434	53	T091027	79	T591027	82	TJ924E	27	TXP1211300000	34
10508161	16	T52EDL	58	T5060CEL7	45	T9212C	56	T106150	35	T591032	83	TJ924F	27	TXP1624533000	34
10508166	122	T52EDO	58	T5120CEL7	45	T9212CC	58	T113100D	79	T591032	83	TJ924H	27	TXP3011300000	34
10508167	122	T52EDT	58	T5180CEL7	45	T9212CD	58	T113112	79	T591050	83	TJ930F	27	TXP3020533000	34
10508168	122	T52PD	55	T5240CEL7	45	T9250	35	T120422	79	T591057	78	TJ930H	27	TXP3020610000	34
10508169	122	T52PDC	58	T5360CEL7	45	T9312C	56	T120422	79	T620100A	79	TJ936H	27	TXP3020762000	34
10508170	122	T52PDO	58	T546EL7	46	T9312CE	58	T120465	79	T620100J	79	TJ942H	27	TXP3024533000	34
10508171	122	T53ED	55	T0702EL4	7	T9312CF	58	T201030	79	T620103	79	TL1354	50	TXP3024610000	34
FG3	56	T53EDA	58	T778	41	T9312CG	58	T201030	79	T620103	79	TL1366	50	TXP3024762000	34
FG4	56	T53EDC	58	T778D	41	T10745	22	T400300	79	T620103	79	TM130	50		
FG5	56	T53PD	55	T0902EL4	7	T10747	22	T529827	79	T620204	79	TM140	50		
FG6	56	T53PDC	58	T909	27	T10755	22	T529827	79	T620204	79	TM141	50		
FG412	56	T71	9	T0912	41	T10756	22	T529827	79	T620204	79	TM141	50		
T1C	57	T76KBT	9	T914H	26	T10757	22	T560745	82	T630500A	79	TM373S6	38		
T1D	57	T77T	9	T914KIT	27	T10758	22	T560745	82	T630519	79	TM444S3	39		
T1SB	56	T84DK	57	T914UEFGT	27	T10765	22	T560747	82	T630520	79	TM444S4	39		
T01T	7	T84L	57	T918H	26	T10767	22	T560748	82	T660032	78	TM444S5	39		
T3C	57	T84O	57	T918KIT	27	T10768	22	T560749	82	T660073	79	TM444S6	39		
T3D	57	T92C	56	T918UEFGT	27	T10769	22	T560750	82	T660073	79	TM1838W	40		
T3SB	56	T92CC	58	T924H	26	T10771	21	T560791	83	T660082	79	TM2083	40		
T03T	7	T92CD	58	T924KIT	27	T12010	51	T560791	83	T660084	79	TM2153	40		
T3TON3VS	54	T92CE	58	T924UEFGT	27	T12012	51	T560791	83	T661053	57	TM2154	40		
T04	41	T92CF	58	T930H	26	T12110	51	T560794	83	T661053	79	TM2226	40		
T4C	57	T92CG	58	T930KIT	27	T12112	51	T560794	83	T676810	78	TM3731	38		
T4D	57	T96	56	T930UEFGT	27	T13250	35	T560794	83	T700024	82	TM3732	38		
T4SB	56	T96F	58	T936H	26	T13611	50	T560803	83	T700032	79	TM4441	39		
T05	41	T96G	58	T936KIT	27	T20030C	78	T560804	83	T702025	79	TM4442	39		
T5C	57	T0102EL4	7	T936UEFGT	27	T20030CD	78	T560804	83	T843423SB	56	TM22006	40		
T5D	57	T112C	57	T942H	26	T20045	78	T560852	83	T850026	78	TM22009	40		
T05T	7	T112DK	57	T942KIT	27	T20045D	78	T560853	83	T41211000	54	TM37312	38		
T6C	57	T112L	57	T942UEFGT	27	T23112	20	T560855	83	TA151	41	TM37314	38		
T6D	57	T112O	57	T1002EL4	7	T23212	20	T560855	83	TA151B	41	TM37318	38		
T6SB	56	T114C	57	T1192	51	T30010	19	T560865	83	TA151R	41	TM37334	38		
T6TON6VS	54	T114DK	57	T1193	51	T30012	19	T560874	83	TBC914H	26	TM37338	38		
T07	41	T114L	57	T1194	51	T30014	19	T560875	83	TBC914KIT	27	TM37358	38		
T07T	7	T114O	57	T1196	51	T30018	19	T560926	83	TBC918H	26	TM44412	39		
T8C	57	T135D	50	T1203	51	T30018A	19	T560936	82	TBC918KIT	27	TM44414	39		
T8D	57	T135E	50	T1204	51	T30018C	19	T561006	83	TBC924E	26	TM44418	39		
T9DR	7	T136D	50	T1206	51	T30024	19	T561008	83	TBC924H	26	TM44434	39		
T9SP	8	T165EL4	8	T1208	51	T30024F	19	T562521	83	TBC924KIT	27	TM44438	39		
T09T	7	T181C	56	T1213	51	T30036	19	T562523	83	TBC930H	26	TM44458	39		
T10T	6	T181CA	58	T1214	51	T30036A	19	T563082	82	TBC930KIT	27	TM220012	40		
T11T	6	T181CB	58	T1216	51	T30036B	19	T563084	82	TBC936KIT	27	TM373112	38		
T13T	6	T181CD	58	T1218	51	T30036C	19	T563084	82	TBC936H	26	TM373114	38		
T14T	7	T182C	56	T1224	51	T30036F	19	T563214	82	TCC26	27	TM444112	39		
T15T	7	T182CA	58	T1352	50	T35010C	20	T563216	82	TF3A1212	82	TM444114	39		
										TF3B1521	82	TM22261012	40		

1 All goods are sold subject to these Conditions which shall prevail over any conflicting conditions sought to be imposed by a customer. These Conditions should be read in conjunction with the Terms as stated below.

Contract

2 Publication of our price list constitutes an offer, and the placing of an order is deemed to be an acceptance of that offer. The resulting contract is subject to these Conditions of Sale.

Property

3 Property in goods shall not pass to buyer until such time as all monies due in any manner or way from Buyer to IRWIN Industrial Tool Company Ltd. have been paid or until Buyer re-sells goods to a third party in the normal course of business. So long as property in goods remains in IRWIN Industrial Tool Company Ltd. and Buyer is in default of any obligation hereunder, IRWIN Industrial Tool Company Ltd. shall have the right without notice to Buyer to retake possession of goods (and for that purpose to go upon any premises occupied by Buyer at any time) and on such retaking the contract on which this condition forms part, shall be terminated. Until property in goods passes to Buyer, Buyer shall keep IRWIN Industrial Tool Company Ltd. informed of the location of goods and shall keep goods in good and marketable condition.

Risk

4 Risk shall not pass at the same time as Property in the goods but shall pass at the time of delivery in accordance with our terms.

Specification

5 We reserve the right to alter without prior notice the specification of any goods listed in the catalogue or price list.

Specials

6 Where any goods are made by us to a customer's design the customer must indemnify us against all claims and liability for breach of any patent, copyright or registered design.

Part Deliveries

7 We reserve the right to make part deliveries against any order and to invoice all such at the time of despatch. Such invoices will be payable notwithstanding that the balance of the order has still to be delivered.

Delivery

8 Delivery of all orders will be made as early as practicable, or as close as practicable to customer's specific requirements. Notwithstanding any delay, however, orders will remain valid and binding.

Cancellation

9 Cancellation of any order or part of an order will be accepted only with our prior consent.

Return of Goods

10 Goods may only be returned with our written consent. On such return they will be credited at the invoice price less a handling charge. Consent will not be given to return goods made specially to order.

Guarantee

11 Our products are guaranteed against defects in material or workmanship subject to fair and proper usage. Any article claimed to be defective will be repaired or replaced free of charge if when returned to us carriage paid, examination confirms such defect, we reserve the right to repair tools, or replace defective parts only, rather than replace the complete article. Customers are not authorised to make replacement of our products without prior approval by us.

Liability

12 Subject to the foregoing guarantee, all warranties express or implied, conditions, undertakings or representations, however imposed, are hereby expressly excluded. We will not be responsible for consequential loss, damages or any other liability, howsoever arising.

Legal Construction

13 These Terms and Conditions shall be construed according to the Law of England, and all sales subject to them shall be deemed to have been made in England.

Box Quantities

14 Products are sold only in unit pack quantities as shown in the Price List.

15 All pricing queries must be notified within 10 days of receipt.

TERMS

Prices

1 Prices shown in our Price List are subject to change without notice.

VAT

2 The RRP prices shown include VAT at the current rate. However, VAT will be charged at the rate ruling at the time of invoice.

Delivery

3 Delivery takes place at customer's warehouse; carriage is paid by us on all orders routed at our discretion.

Order

4 Orders are accepted on the basis of prices ruling at time of despatch. Customers are asked to ensure that their orders are for a minimum value of £120 net.

Payment

5 Payment is due to us by the last working day of the month following despatch.

Shortages

6 Shortage or damage must be reported to us within 48 hours of receipt of consignment by customer.

Non-delivery

7 Non-delivery of a consignment must be notified by customer to us within 21 days from date of despatch to enable us to make a claim upon carriers. Notification outside this period invalidates the claim and no responsibility will be accepted by us.

8 The prior written consent of the Customer will however not be required in case of an assignment to a directly held subsidiary part of the Newell Rubbermaid group.

Errors & omissions excepted – to the best of our knowledge the information supplied in this catalogue or price list is accurate.