



BEST SELLERS 2019



MADE OF FACOM



FACOM IS EUROPE'S LEADING INDUSTRIAL HAND TOOL BRAND, THE NAME IS SYNONYMOUS WITH STRENGTH, DURABILITY AND QUALITY.

Over the last 100 years, FACOM has imposed an unequalled quality standard. This search for excellence is the obsession of the FACOM teams with a range of over 13,000 products, including storage, standard tools, and specialists tools. FACOM utilise cutting-edge technologies to offer a variety of solutions for your industry.





100 YEARS



INNOVATION 2018

HIGH PERFORMANCE DIAGONAL
CUTTERS





192T.18UPE

The most powerful pliers on the market
find them on page 17

Discover the video for the
new high performance
diagonal cutters

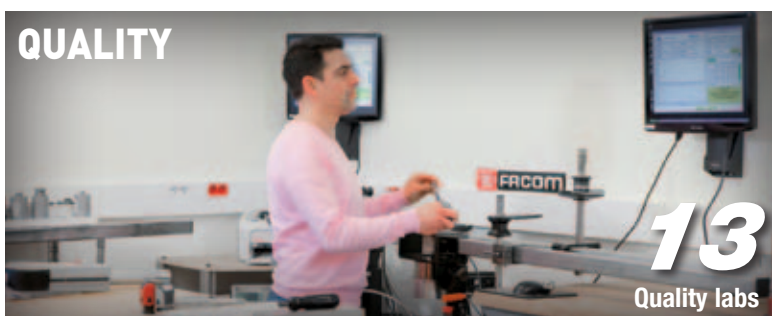



 Eco-contribution is used to finance the cost of collection and the recycling of professional fittings. This Eco-contribution is fixed in addition to the sale price and is calculated based on the weight of the furnishings and the majority of material. These provisions are taken from the Finance Act (No. 2012-1509 of December 29, 2012) as well as article L.541-10-6 of the Environmental Code. This logo certifies that FACOM is a member of Valdelia. By purchasing from a professional displaying this logo, I can make sure that my provider is a corporate citizen contributing to the implementation of a good recycling network.

* Recommended excl. VAT sales prices do not include the environmental contribution amount (WEEE): 2.08 €€€ excl. VAT for stationary machinery; 1.01 €€€ excl. VAT for vacuums (excl. hand vacuums); 0.12 €€ excl. VAT for measurement control instruments; 0.42 €€ excl. VAT for other products.

Made of Facom	2,3
Innovation	4
Summary	5
Customer Testimonial	6,7
Screwdrivers	8,9
Socketry/Bits	10,11
Ratchets/Sockets	12, 13
Hex Keys	14
Pliers	15,16,17
lock Grips	18
Impact Tools	19
Wrenches	20,21,22
Angled/Adjustable Wrenches	23
Electrical	24,25,26,27
Cutting	28
Sawing	29
General Miantenance	30
Measurment/Metrology	31
Lighting	32,33,34,35
Pullers	36
Safety Solutions	37
Torque Control	38,39
Power Tools	40, 41
Cordless Power tools	42,43
Automotive Tools	44,45
Presses	46
Workwear	47
Soft Storage	48,49,50
Metal & Plastic	
Toolbox/Organisers	51
Roller Cabinets	52,53,54,55,56,57
Chests/Roller Chests	58,59
Workbenches	60
Jetline	61
Toolkits	62
Facom Modular Kits	63,64,65,66
Facom 5's	67
Contacts	68
Notes	69
Facom Guarantee	70,71

DON'T JUST TAKE OUR WORD FOR IT...

Here at Dennis Eagle, we are the UK Market Leader in Manufacturing of Refuse Collection Vehicles (RCV's) for the TRRG group. With our European headquarters located in Warwick. We produce over 1000 RCV's per year and we needed to find a complete tooling solution which would fit in with our lean manufacturing and our requirements for visually managed tooling in our manufacturing plants.

FACOM provided us with a professional bespoke tooling solution in keeping with our meticulous requirements. FACOM has delivered a one-stop shop for all our tooling needs all from one supplier. Helping us obtain full traceability, through a high-quality laser etching service to prevent loss, along with high quality foam inlays inserted into each of the drawers with recessed cut-outs to the exact size and shape of the tool, incorporating quick and easy visual tooling management. This has given us a complete standardised range of tools for use within our complex production lines when assembling our RCV product. All of this was achieved with the assistance of the dedicated technical sales rep from FACOM.

**FACOM TOOLS CAN STAND UP TO OUR CHALLENGE
& THE FACOM LIFETIME GUARANTEE MEANS THEY
CAN STAND UP TO YOURS!**



CARL FAWSON





CLIENT TESTIMONIAL: DENNIS EAGLE

SCREWDRIVERS

SCREWDRIVER *Protwist*[®]

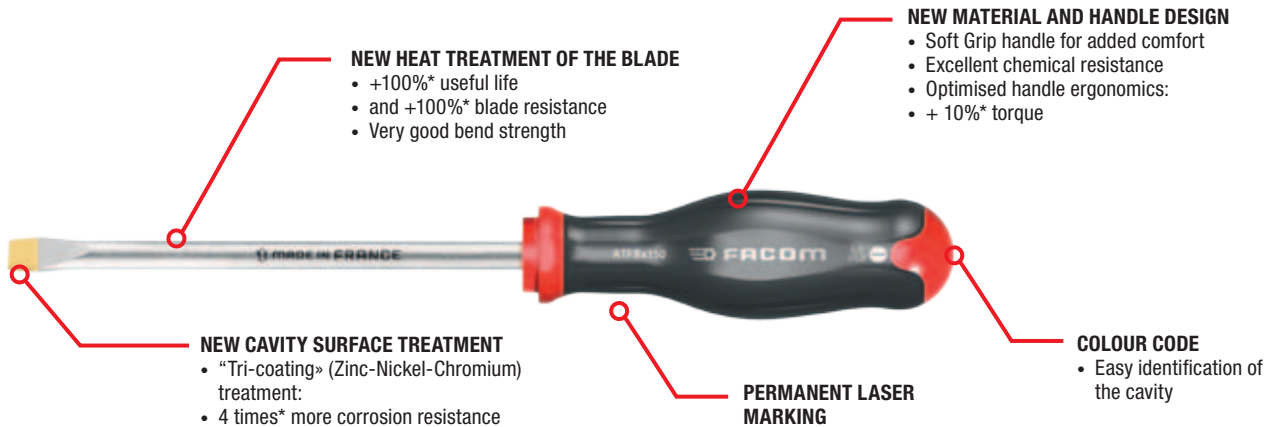

NEW HEAT TREATMENT OF THE BLADE

- +100%* useful life
- and +100%* blade resistance
- Very good bend strength

NEW MATERIAL AND HANDLE DESIGN

- Soft Grip handle for added comfort
- Excellent chemical resistance
- Optimised handle ergonomics:
- + 10%* torque

NEW CAVITY SURFACE TREATMENT

- "Tri-coating" (Zinc-Nickel-Chromium) treatment:
- 4 times* more corrosion resistance

PERMANENT LASER MARKING

COLOUR CODE

- Easy identification of the cavity

* Compared to the current FACOM PROTWIST[®] screwdriver.

Set of 4 long screwdrivers

- 4 X 200 • 5.5 x 200
- 1 x 250 • 2 x 250



AT.J4PB

£46.87

Set of 6 screwdrivers

- 3.5 x 75 • 4 x 100
- 5.5 x 150 • 6.5 x 150
- 1 x 100 • 2 x 125



AT.J5PB

£49.59

kg 0.675 kg

Set of 8 screwdrivers

- AT round blade**
- 4 x 100 • 5.5 x 125
 - 6.5 x 150 • 8 x 150
 - 1 x 100 • 2 x 125
 - 1 x 100 • 2 x 125



AT.J8PB

£73.14

kg 0.90 kg

Set of 10 screwdrivers

kg 1.12 kg

AT round blade

- 2.5 x 75 • 3.5 x 100 • 5.5 x 125
- 0 x 75 • 1 x 100 • 2 x 125
- 1 x 100 • 2 x 125

ATW hex blade

- 6.5 x 150
- 8 x 175

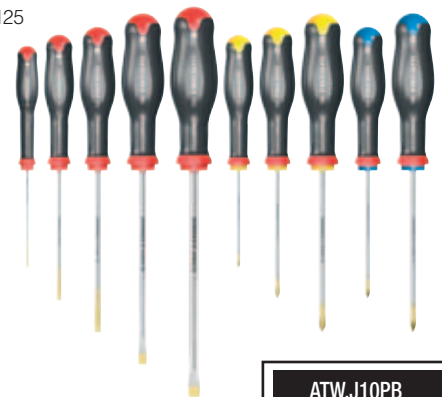

ATW.J10PB

£90.78

Set of 5 impact screwdrivers

kg 0.831 kg

- Excellent grip
- High resistance
- 4 x 100CK
- 6.5 x 150CK
- 8 x 175CK
- 1 x 100CK
- 2 x 125CK



COMBINES
POWER, SPEED AND
ACCESSIBILITY

ATWCK.J5PB

£94.80

Set of 3-in-1 ratchet screwdrivers – 5 items



QUICK

- Ratchet function on screwdriver



POWER

- T-key function



COMPACT

- Screwdriver function

Drive mechanism: 1/4" hex

Includes:

- ACL.2A: reversible blade holder handle
- AMZ.E: 1/4" hex bit holder blade
- AMZ.P1-2: Phillips® PH1 - PH2 reversible blade
- AMZ.S3.5-4: Pente® 3.5 - 4 mm reversible blade
- AMZ.S5.5-6.5: Pente® 5.5 - 6.5 mm reversible blade
- AMZ.D1-2: Pozidriv® PZ1 - PZ2 reversible blade

ACL.2A5

£127.01

3-IN-1 RATCHET SCREWDRIVER

QUICK

- Ratchet function on screwdriver to work faster.

COMPACT

- Nano function on screwdriver for confined spaces.

COMPLETE

- Supplied with a blade tip holder and a box of 28 tips for assorted drivers.

POWERFUL

- T-key function to work with greater power.



T-key function: power



Nano screwdriver



Fast • Powerful

Compact

3-in-1 PROTWIST screwdriver set®

3-in-1 screwdriver + blade tips + box of 28 assorted tips.



ACL.2A2

£119.24

RATCHETBIT SCREWDRIVER



Filler plug

A second charger with 7 Torx Tamper bits®

High performance ratchet
5° offset angle

PROTWIST® ratchet + 15 bits

- No.4 - 6.5 mm PH1 - PH2
- PZ1 - PZ2 4 - 6 mm
- No. TT 10 - 15 - 20 - 25 - 27 - 30 - 40

ATCL.1AT

£45.60

5-PIECE SCREWDRIVER SET

MICRO-TECH® 5-PIECE SCREWDRIVER SET SLOTTED HEAD - PHILLIPS®



Comprising:

- 4 slotted head screwdriver: AEF.1.5x35 - AEF.1.8x35 - AEF.2x35 - AEF.2.5x35.
- 1 Phillips® screwdriver: AEFP.00x35.
- Case dimensions: L.178 x W.91 x H.25.

Weight: 170 g.

AEF.J1

£32.88

HEXAGONAL V 1/4" SOCKET SET

NEW

NEW ULTRA-COMPACT HEXAGONAL SOCKETS

- Excellent addition to 1/4" sockets = new compactness as a result of external hex profile
- Go-through socket up to M5, compatible with a go-through ratchet (R.180HX), a classic 1/4" ratchet, a combination wrench of 11 mm

NEW FLEXIBLE RATCHET HEAD

- Go-through ratchet head
- Flexible head 180°; can be locked into position.
- Retainer ring to hold the socket

50% MORE COMPACT

- The height of the ratchet set + socket does not exceed 18 mm!

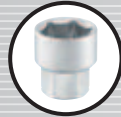

Optimal

accessibility & compactness



x11
tools

Box details:

- 1 ratchet \varnothing 1/4", compact R.180HX
- 10 hex sockets R. 5.5 > 14 mm

RXPICO

£104.75

CASES AND RATCHET \varnothing 1/4" COMPACT



FLEXIBLE HEAD

180°; can be locked into position (13 positions)

BIT HOLDER

at the handle end

SOCKETS & BITS

Thanks to the socket bit holder = compactness



EXTENSION 100 MM

Supplied with ratchet and cases. Possible use in T HANDLE

Ratchet \varnothing 1/4"

ultra-compact flexible head

- 60 teeth mechanism (offset 6°)

R.180

£59.49

Tightening/screwing set

\varnothing 1/4"

- 1 ratchet \varnothing 1/4" R.180
- 5 sockets R.6 - 8 - 10 - 12 - 13 mm
- 15 assorted bits
- 1 socket bit holder
- 1 extension bar, 100 mm



x23
tools

R1PICO

£95.00

Screwing set \varnothing 1/4"

- 1 ratchet \varnothing 1/4" R.180
- 28 assorted bits
- 1 socket bit holder
- 1 extension bar, 100 mm



x31
tools

R.180J31

£101.44

SCREW BITS \varnothing 1/4" 25 MM IN CASE



Set of 10 Torx® bits

EX.108 > EX.140

E.112

£29.29

Set of 10 Resistorx® bits

EXR.110 > EXR.140

E.113

£33.05

Set of 10 Torx® Plus Tamper Resistant bits

EXRP.108 > EXRP.140

E.114

£38.45



EF6P1 bit holder (in each set)

Set of 28 "High Perf" bits

- 3 x ES.134.5T > ES.148T
- 6 x EP.101T > EP.103T
- 6 x ED.101T > ED.103T
- 4 x EH.103 > EH.106
- 9 x EX.110 > EX.140

E.120

£55.16

CLAMPING BOX \varnothing 1/4" WITH LONG AND SHORT SOCKETS

Box details:

- 1 ratchet \varnothing 1/4" round head R.161B
- 10 short sockets: R. 5.5 > 14 mm
- 9 long sockets: R. 6 > 14 mm
- 2 extension bars: 55 mm - 100 mm
- 1 cardan shaft
- 1 spinner
- 1 bit holder 6.35 mm
- Dim. (L x D x H): 329 x 215 x 59 mm

21 tips L 25 mm - 6.35 mm

- PH1 - PH2 - PH3
- PZ1 - PZ2 - PZ3
- 4.5 - 6.5 - 8.0 mm
- 3 - 4 - 5 - 6 - 7 mm
- 10 - 15 - 20 - 25 - 27 - 30 - 40
- Box and module, medium Mbox size (see presentation of new Mbox and module boxes, page 10)



Indispensable and 100% useful

x46
tools

R.2BL

£366.46

RATCHET \square 1/4" ROUND HEAD SEALED AND COMPACT

- Ultra-compact head (10% more compact). Rotating cap for reversal
- 72 teeth mechanism - offset 5°
- Dust-proof, industrial dust IP51
- Bi-material handle: optimal comfort, high resistance to abrasion and the most severe workshop solvents

- Hook in the handle
- Included: 1 colour chip to customise the ratchet
- Very lightweight: 78 g



R.161B
£49.89

ACCESSIBILITY & SPEED TO HAND

AXS - 1/4" Reduction: 1:1.5

Accessibility in tight spaces

This new accessory is designed for tackling jobs away from narrow spaces where a ratchet handle would be moved back and forth numerous times, thus facilitating the tightening or loosening action.

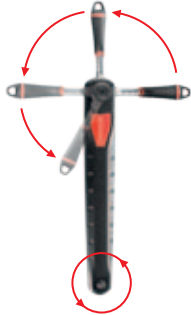

AXS.S
£86.51

AXS - 3/8" Reduction: 1:1.3

Speed

Time saving: no need to free up space to access screws or nuts. The first advantage of moving away from a narrow space is the ability to move the ratchet handle back and forth more quickly. The asymmetrical design of the product also allows 1.6 turns of the bar (1/2") for only 1 turn of the ratchet. Can be used with manual or motorised ratchet (air actuated or electric).



AXS.M
£92.69

AXS.S 1/2" Reduction: 1:1.6

Power

The second advantage of moving away from a narrow space is that more power can be applied to the ratchet handle than if it were in a narrow space.



AXS.L
£105.06

ROUND HEAD RATCHET VERSION



WITH NEW ROUND HEAD RATCHET R.161B



Radio case \square 1/4"; 38 parts with ratchet with round head R.161B
• Dimensions (L x D x H): 220 x 195 x 90 mm

R2NANO
£226.24

ROTATING SLEEVE RATCHET VERSION



Simply turn the handle to rotate the square drive.



Radio case \square 1/4"; 38 parts with ratchet with rotating handle R.360
• Dimensions (L x D x H): 220 x 195 x 90 mm

R.360NANO
£230.36

Ratchet with rotating handle \square only L 1/4"
• Dimensions (L x D x H): 120 x 27 x 29 mm

R.360
£66.97

SOCKET/BITS BOX \square 1/4" WITH RATCHET R.161B

Box details:

- 1 ratchet \square 1/4" round head R.161B
- 10 metric hex sockets R. 5.5 - 6 - 7 - 8 - 9 - 10 - 11 - 12 - 13 - 14 mm
- 2 extension bars 55 mm - 100 mm
- 1 cardan shaft
- 1 spinner
- 1 socket bit holder, 1/4" - 6.35 mm
- Dim. (L x D x H): 210 x 133 x 59 mm

21 bits \square 1/4"

- PH1 - PH2 - PH3
- PZ1 - PZ2 - PZ3
- 4.5 - 6.5 - 8.0 mm
- 3 - 4 - 5 - 6 - 7 mm
- 10 - 15 - 20 - 25 - 27 - 30 - 40
- Box and module, small Mbox size (see presentation of new Mbox and module boxes, page 10)



x37
tools

R.161-6M6
£260.58

RATCHETS AND SOCKET CLIQUETS \square 1/2"

RATCHET \square 1/2" ROUND HEAD, SEALED AND COMPACT

- Ultra-compact head (10% more compact)
- Reversal through rotating cap
- 72 teeth mechanism - offset 5°
- Dust-proof, industrial dust, IP51: increase the life of the ratchet
- Bi-material handle: optimal comfort, high resistance to abrasion and the most severe workshop solvents



- Hook in the handle
- Included: 1 colour chip to customise the ratchet
- Lightweight: 410 g



Check out the video of the ratchet by scanning this code



S.161B

£63.71

MBOXES AND SETS



3 AVAILABLE SIZES

Large

Medium

Small

OPENING of 180°, flat box
AUTOMATIC CLOSURE
STACKABLE for easy storage

ANTI-SLIP, due to anti-slip pads
CUSTOMISABLE, box supplied with a sheet of stickers



100% COMPATIBLE
The module fits in the Mbox as well as in the drawers of the service cart.

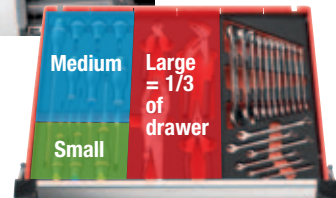

BOXES \square 1/2" WITH RATCHET, ROUND HEAD S.161B

x19
tools



Box details:

- 1 ratchet \square 1/2" round head, sealed S.161B
- 1 universal cardan shaft \square 1/2"
- 1 extension bar \square 1/2": 130 mm
- 16 sockets \square 1/2": 10 - 11 - 12 - 13 - 14 - 15 - 16 - 17 - 18 - 19 - 21 - 22 - 24 - 27 - 30 - 32 mm
- Dim. (L x D x H): 329 x 215 x 59 mm
- Box and Mbox storage, medium size

S.161-2P6

£267.14

x26
tools



Box details:

- 1 ratchet \square 1/2" round head, sealed S.161B
- 1 universal cardan shaft \square 1/2"
- 2 extension bars \square 1/2": 130 mm - 250 mm
- 1 sliding handle \square 1/2"
- 21 sockets \square 1/2": 8 - 9 - 10 - 11 - 12 - 13 - 14 - 15 - 16 - 17 - 18 - 19 - 21 - 22 - 23 - 24 - 27 - 28 - 29 - 30 - 32 mm
- Dim. (L x D x H): 434 x 270 x 70 mm
- Box and Mbox storage, large size

S.161-4P6

£363.53

MIXED BOX \square 1/4" AND \square 1/2"

Set details for "RADIO" \square 1/4":

- 1 ratchet \square 1/4" round head R.161B
- 9 sockets: R. 5,5 - 6 - 7 - 8 - 9 - 10 - 11 - 12 - 13 mm
- 1 extension bar, 100 mm
- 1 cardan shaft
- 1 spinner

Set details for "STANDARD" \square 1/2":

- 1 ratchet \square 1/2" round head S.161B
- 14 sockets: S.H 10 - 11 - 12 - 13 - 14 - 15 - 16 - 17 - 18 - 19 - 21 - 22 - 24 - 27 mm
- 1 extension bar, 130 mm
- 1 universal cardan shaft
- Dim. (L x D x H): 329 x 215 x 59 mm
- Box and Mbox storage, medium size



x30
tools

Multiple solutions!

RS.161-1

£394.20

CASES \square 1/2" DETECTION BOX

DETECTION BOX



REINFORCED SAFETY

- The "Detection BOX" concept allows you to make an instant inventory even if the box is closed.
- The user is far less likely to forget a tool in a machine or motor at the end of the job; the risks of accidents are thus greatly reduced.
- This concept therefore meets the Foreign Object Damage (FOD) specifications required by certain industries.



EASY TO TRANSPORT



EASY TO STORE



HIGHLY RESISTANT



SAVE TIME WHEN CHOOSING A SOCKET

ROUND HEAD RATCHET VERSION

x21
tools



Box details:

- 1 ratchet \square 1/2" round head S.161B
- 17 metric hex sockets:
S.H 8 - 10 - 11 - 12 - 13 - 14 - 15 - 16 - 17 - 18 - 19 - 21 - 22 - 24 - 27 - 30 - 32 mm
- 2 extension bars 130 mm - 250 mm
- 1 cardan shaft
- Dim. (L x D x H): 340 x 185 x 58 mm

S.161DBOX1
£280.08

ROTATING SLEEVE RATCHET VERSION

x22
tools



Box details:

- 1 ratchet \square 1/2" with twist handle S.360
- 19 metric hex sockets:
S.H 8 - 9 - 10 - 11 - 12 - 13 - 14 - 15 - 16 - 17 - 18 - 19 - 21 - 22 - 23 - 24 - 27 - 30 - 32 mm
- 1 sliding handle 275 mm
- 1 angular extension bar, 130 mm
- Dim. (L x D x H): 340 x 185 x 58 mm

S.360DBOX4
£322.21

Ratchet \square 1/2" rotating handle

- Rotating handle: ideal for working in hard to reach areas

S.360
£76.98

EXTENDABLE SLEEVE RATCHET VERSION

x21
tools



Box details:

- 1 ratchet \square 1/2" extensible SXL.161
- 17 metric hex sockets - S.H 8 - 10 - 11 - 12 - 13 - 14 - 15 - 16 - 17 - 18 - 19 - 21 - 22 - 24 - 27 - 30 - 32 mm
- 1 universal cardan shaft
- 2 extension bars 130 mm - 250 mm
- Dim. (L x D x H): 340 x 180 x 58 mm

SXL.DBOX1
£300.40

Ratchet \square 1/2" extensible handle

- Max. length 397 mm
- 8 pre-set positions secured by lock-back blade

SXL.161
£99.66

CASES \square 3/4" SPECIAL HEAVY LOADS

Box details:

- 1 sealed ratchet \square 3/4" KL.161
- 13 metric hex sockets KHB 19 - 21 - 22 - 24 - 27 - 30 - 32 - 34 - 36 - 41 - 46 - 50 - 55 mm
- 2 extension bars 200 mm - 400 mm
- 1 sliding handle
- 1 cardan shaft
- Dim. (L x D x H): 590 x 440 x 130 mm

KL.500
£604.73



x18
tools

Ratchet \square 3/4" sealed
• Dust-proof, industrial dust



KL.161
£155.11

HEX KEYS

ALLEN KEYS IN CASE



Total access to every wrench

Instant tracking of all dimensions

Maintain consistency of wrenches over time

Easy hanging of hard-wearing case

• Set of 8 male Torx® keys with spherical heads, in case

- 10 - 15 - 20 - 25 - 27 - 30 - 40 - 45

X8

89S.JP8A
£34.37



Torx®



Torx® spherical



Resistorx®

Magnetised / demagnetised case
Specifically where access is difficult

• Set of 7 male Torx® keys and Resistorx® with spherical heads, in case

- 10 - 15 - 20 - 25 - 27 - 30 - 40

X7

89SR.J7
£44.29

* except wrench No.10

Set of 6 male Torx keys® in case:

- 10 - 15 - 20 - 25 - 30 - 40

X6

89R.JP6
£31.26

• Set of 9 long hex keys with spherical heads, in case

- 1.5 - 2 - 2.5 - 3 - 4 - 5 - 6 - 7 - 8 mm

X9

83SH.JPAA
£28.61

• Set of 9 long hex keys with spherical heads, in case

- 1.5 - 2 - 2.5 - 3 - 4 - 5 - 6 - 8 - 10 mm

X9

83SH.JP9A
£29.42



Hex spherical head 30°

• Set of 9 extra-long hex keys with spherical heads, in case

- 1.5 - 2 - 2.5 - 3 - 4 - 5 - 6 - 8 - 10 mm

X9

83S.JP9AL
£41.45

ALLEN KEYS IN A "T"

Set of 6 Allen keys in a "T"

- Sliding crossbar with "T" handle for easy accessibility
- 2,5 - 3 - 4 - 5 - 6 and 8 mm

84TCD.J6
£127.69

KEYS "P" 6 KEYS

NEW

SHORT HEX KEY

- For confined spaces.

EXCLUSIVE DESIGN

Best ergonomics and comfort

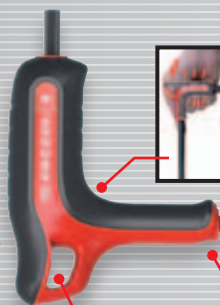

HANGING HOLE
For easy storage

ERGONOMIC BI-MATERIAL HANDLE

- Comfortable grip = less risk of slipping, less fatigue
- Asymmetrical handle = comfort and power in 2 positions

FINGER PROTECTION
Better control

BLACK OXIDISED COATING
Improves corrosion resistance

SPHERICAL HEAD

for access at 30°



ROBUST STEEL BLADE

High torque resistance and long service life of tips (ISO 2936)

Set of 6 hex keys with metric ball handle

- 3 - 4 - 5 - 6 - 7 - 8 mm

84TZSA.PB
£63.69

MULTIGRIP PLIERS SLIP-JOINT



POWER

- The very close position of the arms and their ergonomics enables more powerful tightening.

Close arms: power

PRECISE AND ROBUST

- The 12-position rack and the interchangeable pivot provide precision and robustness.

REFINED HEAD

- Self-tightening teeth to work more easily on inaccessible parts, especially with the EF version where the head has been lengthened; ideal for difficult access.

2 POSSIBLE FINISHES

- CPE version:** chrome plated, ergonomic bi-material handles
- G version:** polished, ergonomic handles.



Precise rack, 12 positions



Fast and easy pivot



Multigrip pliers 180 mm

- Chrome plated, ergonomic bi-material handles

181A.18CPE

£45.04



Multigrip pliers 250 mm

- Chrome plated, ergonomic bi-material handles

181A.25CPE

£46.25



Multigrip pliers 250 mm, elongated head

- Chrome plated, ergonomic bi-material handles

181EF.25CPE

£52.75

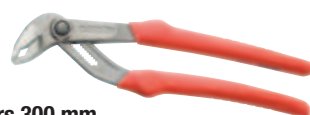

Multigrip pliers 300 mm

- Polished, ergonomic handles.

181A.30G

£62.39

SET OF TWO EXTRA LONG TONGS

Ergonomic handle for easy grip and comfort

185.34L

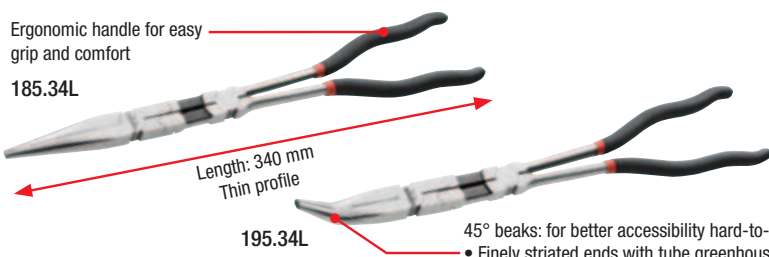

Length: 340 mm
Thin profile

195.34L

45° beaks: for better accessibility hard-to-reach areas
• Finely striated ends with tube greenhouse

- To work in the areas difficult to access:
 - H.P. pump valves on V.U.L.
 - Gasoil return fittings
 - candles, candles and fittings water hoses
- To recover :
 - the lamp holders behind the dashboards
 - lost parts at the bottom of a engine compartment

185.2L

£67.18

PLIERS FOR CIRCLIPS®

PERFORMANCE AND SECURITY

- Control wire tips
- Recessed spring: optimal flexible usability.
- Tips elongated and oriented at 10°.

COMFORT AND ERGONOMICS

- PVC anti-slip covering in granite.

FINESSE AND ACCESSIBILITY

- Head and tips refined for easier access even in crowded spaces.

PRODUCTIVITY

- Colour coding: opening/closing.
- Increase productivity by faster identification of pliers in the toolbox.

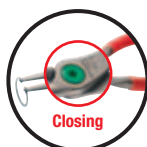

Closing



Opening

Pliers for specifically where access is difficult

For Circlips® diameter		
10 - 25 mm	-	177A.13
19 - 60 mm	-	177A.18
-	12 - 25 mm	179A.13
-	19 - 60 mm	179A.18

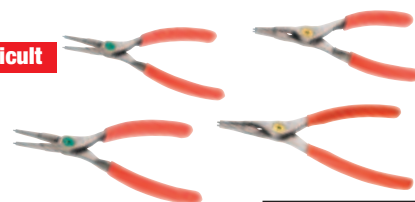

Set of 4 needle nose pliers

PCSNJ4

£97.72

For Circlips® diameter		
19 - 60 mm		177A.18
		197A.18
		179A.18
		199A.18



Set of 4 needle nose pliers and 90° angled jaws

PCJ4

£104.84

CPE SERIES AND G SERIES CLAMPS

NEW

CPE SERIES

Increased durability • Less effort

Optimal comfort



RETURN SPRING

- Reduces stress and fatigue of the user (removable: cut to remove).

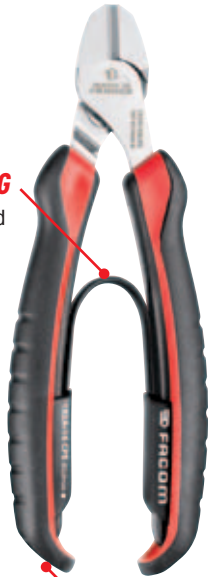

SOFT GRIP MATERIAL HANDLES

- For optimal comfort.
- Sculpted with front guard for a natural support and easy handling.



Check out the video of the new CPE series pliers

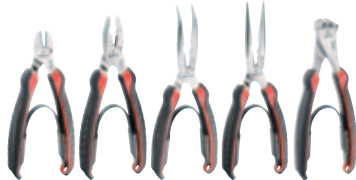

G SERIES

Accessibility • Ergonomics



OPTIMISED CUTTING EDGES

- Higher cutting specifications.
- Maximum resistance to corrosion: chromium plated (CPE series pliers), painted finish treatment (G series clamps).



ERGONOMICS AND COMFORT

- Upper part is thinner = natural support and easy handling.
- Lower wider part: better contact with the pliers, more comfort.

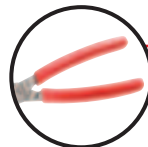

PVC COATED HANDLES

- For easy cleaning.

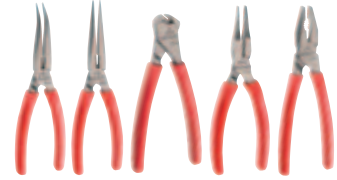

Set of 4 CPE series pliers

- 1 large capacity multigrip pliers (180.CPE)
- 1 diagonal cutting pliers (192A.16CPE)
- 1 half-round longnose pliers (185A.20CPE)
- 1 pair of combination pliers (187A.18CPE)

CPE.A1
£136.04

Set of 3 CPE series pliers

- 1 multigrip locking pliers (181A.25CPE)
- 1 diagonal cutting pliers (192A.16CPE)
- 1 half-round longnose pliers (185A.20CPE)

CPE.A5
£120.28



Set of 4 G series pliers

- 1 multigrip locking pliers (170A.25)
- 1 diagonal cutting pliers (192A.16G)
- 1 half-round angled longnose pliers 185A.20G
- 1 half-round longnose pliers (185A.20G)

GJP.A4
£142.37

CUTTING PLIERS DIAGONAL POWER DEMULTIPLIED

NEW

INNOVATION

The highest possible level of performance on the market



RETURN SPRING

- Reduces stress and fatigue of the user.



50% LESS CUTTING EFFORT REQUIRED*

- Patented cam profile and optimised kinematics.
- Increases the cutting force by maintaining a compact opening in the hand.

* Compared to FACOM 180 mm diagonal cutting pliers (192.18CPE)



EXCEPTIONAL CUTTING PERFORMANCE

- Max. cut Ø 3.0 mm of control wire.
- Forged head profile reduces tension points and offers a very high resistance to wear.



COMFORT AND GRIP

- Ergonomics and compact soft grip handles for optimal comfort.
- Sculpted upper part with front guard ensuring a natural support and facilitating handling



HANGING HOLE



MAX. Ø 3 MM OF CONTROL WIRE



PATENTED CONCEPT

Discover the video for the new high performance diagonal cutters



192T.18UPE

£69.68

CLAMP VICES

LONG NOSE LOCK-GRIP PLIERS 501A

Simplicity • safety • robustness

UNLOCK WITH ONE HAND, NO IMPACT = SAFETY

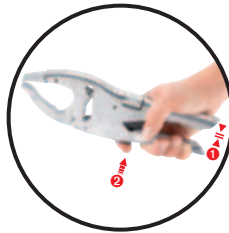

INSTANTLY OPEN WITH ONE HAND = SAVE TIME



STRENGTHENED, FORGED JAWS

- Powerful clamping
- Long service life

PARALLEL TOOTHED JAWS ALONG ENTIRE DEPTH

- Item will not slip

PATENTED OPENING SYSTEM FOR GROOVES

- Very quick adjustment for any item

5 GROOVE POSITIONS

- Large adjustment range

ERGONOMIC HANDLES

- Easy and comfortable grip with or without gloves

ATTACHMENT SAFETY LOCK SYSTEM

- For working at height without the risk of losing the tool
- FME compatible

Max. openings mm

501A
£69.32

SHORT NOSE LOCK-GRIP PLIERS



500A SERIES

Max. openings mm

500A
£57.64

LARGE CAPACITY LOCK-GRIP PLIERS



505A

Max. openings mm

505A
£69.32

HINGED LONG NOSE LOCK-GRIP PLIERS



506A

Max. openings mm

506A
£74.81

SINGLE SETTING LOCK-GRIP PLIERS



501AMP

Max. openings mm

501AMP
£57.64

IMPACT TOOL

Set of 7 pin punches in case

- Ø 2 - 3 - 4 - 5 - 6 - 8 - 10 mm



248.JT7

£74.76

Tip automatically sheathed

- Adjustable power from 15 to 25 kg
- Tip hardened to 57-60 HRc
- Adjustable impact

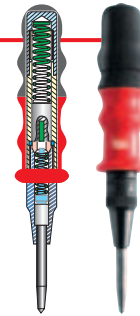

257.G

£61.11

Recommended by CHSCT



Set of 5 sheathed pin punches

- Ø 3 - 4 - 5 - 6 - 8 mm
- Shock absorbent handle
- Delivered in a stackable organiser box

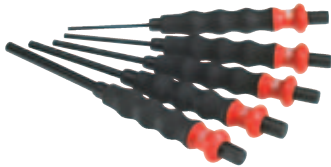

249.GPB

£53.85

Set of 3 chisels and 1 cape chisel

- Chisel blades: 15 - 20 - 25 mm
- Cape chisel blade: 10 mm
- Shock absorbent handle
- Delivered with stackable storage stand

263.GPB

£73.87

TRI-MATERIAL ENGINEER'S HAMMER

MAXIMUM SECURITY

- Unbreakable: head and shaft attached using epoxy-resin
- Cannot be broken

SECURE GRIP

- Elastomer: soft material for a good grip
- Extended guard so the hammer does not slip

COMBINATION OF 3 MATERIALS FOR THE PERFECT RESULT

- Graphite: better resistance No risk of the neck snapping
- Polypropylene: fewer vibrations
- Elastomer: perfect grip and excellent resistance against corrosive liquids in workshops

TOTAL COMFORT

Anti-vibration: absorbent material and fine-tuned striking action to reduce vibration



Fibre Riveting Hammer

W mm	H mm	L mm	kg	
93	30	270	0.470	200C.30 £18.61
100	32	300	0.585	200C.32 £20.29
106	35	300	0.725	200C.36 £22.62
108	40	330	1.025	200C.40 £27.49
138	50	360	1.910	200C.50 £40.52

Profiber

HICKORY ENGINEER'S HAMMER

Hickory handle: more resistant!

TRIPLE JOINTING

HEXAGONAL HANDLE Better grip

THERMAL TREATMENT Differentiated from the head

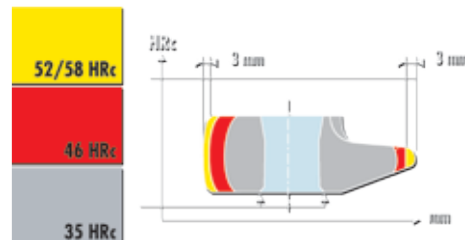

Hickory Riveting Hammer

W mm	H mm	L mm	kg	
93	30	270	0.527	200H.30 £16.25
100	32	300	0.565	200H.32 £17.47
106	35	300	0.781	200H.36 £18.43
108	40	330	1.063	200H.40 £21.78
138	50	360	1.925	200H.50 £27.70

RATCHETING COMBINATION WRENCHES

COMBINATION WRENCHES 440

NEW



CONTROL DURING THE APPROACH PHASE

- Open end angled at 15° for access at the side and 15% thinner for better accessibility
- Greater stability
- The wrench does not turn in the hand

ACCESSIBILITY

- Release of box-end to access nuts in series or semi-recessed nuts

COMFORT

- Handle with variable section to double support surface for the hand
- Pain-free torque transfer



New pocket case

x10

Set of 10 combination wrenches, 440, in carry-case

- Dimensions: 8 - 10 - 11 - 12 - 13 - 14 - 16 - 17 - 18 - 19 mm

440.JP10

£100.64

x12

Set of 12 combination wrenches, 440, in carry-case

- Dimensions: 7 - 8 - 10 - 11 - 12 - 13 - 14 - 15 - 16 - 17 - 18 - 19 mm

440.JP12A

£104.03

x14

Set of 14 combination wrenches, 440, in carry-case

- Dimensions: 7 - 8 - 10 - 11 - 12 - 13 - 14 - 15 - 16 - 17 - 18 - 19 - 22 - 24 mm

440.JP14

£120.64

RATCHET COMBINATION WRENCHES

NEW

SHORT

40% more compact than a traditional combination ratchet wrench

INCREASED COMFORT

Handle with variable section to double support surface for the hand

DESIGN EXCLUSIVE TO FACOM

ARTICULATED BOX END

- Extra easy to handle: suitable for applications requiring an ultra-compact ratchet
- Optimal accessibility

Ultra-compact

Ideal where access is difficult

Versatile

Extra easy to handle

Extra powerful

ANTI-SLIP OPEN END

- Open end angled at 15° for access at the side
- Greater productivity and increased safety

NEW POCKET CASE

- Instantly identify the size of the wrench required
- Ultra-compact

NEW POCKET CASE

- Instantly identify the size of the wrench required
- Case can be opened flat

Set of 6 stubby ratchet combination wrenches in carry-case

- 467BS. 8 - 10 - 11 - 12 - 13 - 14 mm

x6

467BS.JP6

£105.81

Set of 10 stubby ratchet combination wrenches in carry-case

- 467BS. 7 - 8 - 10 - 11 - 12 - 13 - 14 - 15 - 16 - 17 mm

x10

467BS.JP10

£198.19

Set of 10 articulated end ratchet combination wrenches in carry-case

- 467BF. 8 - 10 - 11 - 12 - 13 - 14 - 16 - 17 - 18 - 19 mm

x10

467BF.JP10

£267.77

Set of 12 articulated end ratchet combination wrenches in carry-case

- 467BF. 7 - 8 - 10 - 11 - 12 - 13 - 14 - 15 - 16 - 17 - 18 - 19 mm

x12

467BF.JP12

£250.96

NEW CASE PRACTICAL



PRACTICAL

- New case for combination wrench sets and combination ratchet wrenches
- Case can be opened flat
- Instantly identify the size of the wrench required

COMPACT

- Allows you to carry a set of wrenches in your hand, a pocket, your toolbox, roller cabinet, etc.

SECURE

- Lock by "clipping" in the wrenches
- Automatic inventory: no risk of forgetting wrenches once you've finished the job



ULTRA GRIP COMBINATION RATCHET WRENCH

ANTI-SLIP OPEN END

- Open end angled at 15° for access at the side
- Greater productivity and increased safety
- Unique design: less stress on nut



INCREASED COMFORT

- Handle with variable section to double support surface for the hand
- Pain-free torque transfer

INTEGRATED REVERSER

- Avoid any risk of accidental reversing

BOX END

- Ratchet mechanism with 5° offset angle, angled at 15°

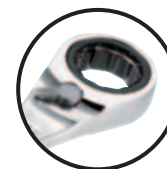

BOX-END WITH RETAINING RING

- Grips the nut so the wrench does not slip (quicker clamping)



x10

x12

Set of 10 ratchet combination wrenches in carry-case

- 467B. 8 - 10 - 11 - 12 - 13 - 14 - 16 - 17 - 18 - 19 mm

467B.JP10

£239.18

Set of 12 ratchet combination wrenches in carry-case

- 467B. 7 - 8 - 10 - 11 - 12 - 13 - 14 - 15 - 16 - 17 - 18 - 19 mm

467B.JP12

£284.48



x7

Set of 7 ratchet combination wrenches

- 467B. 8 - 10 - 12 - 13 - 14 - 17 - 19 mm

467B.J7

£163.16

SET OF COMBINATION QUICK RELEASE RATCHET WRENCHES

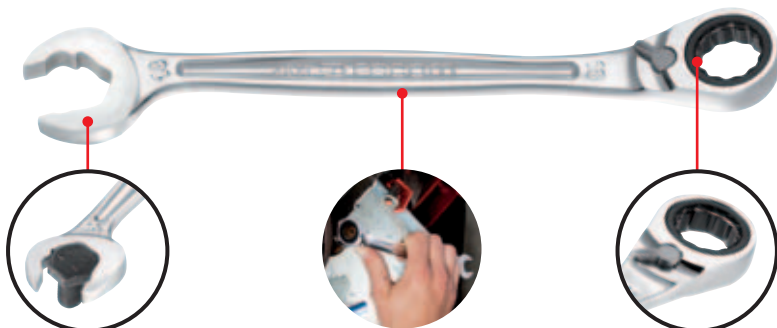

BOX-END WITH RETAINING RING

- Grips the nut so the wrench does not slip (quicker clamping)

NEW DUAL ACTION OPEN END

- Ratchet effect for quick tightening
- Standard use on nozzle tips for approach phases

INCREASED COMFORT

- Handle with variable section to double support surface for the hand
- Pain-free torque transfer

REVERSIBLE RATCHET OPEN-END

- 5° offset angle
- Integrated reverser: avoid any risk of accidental reversing

Set of 10 quick release ratchet combination wrenches in carry-case

- 467BR. 8 - 10 - 11 - 12 - 13 - 14 - 16 - 17 - 18 - 19 mm



x10

467BR.JP10

£263.10

RATCHETING WRENCHES

ULTRA-COMPACT MULTI-SERVICE BOX

NEW



Work safely
Ease of access



x39
tools

Box details:

- 6 new stubby combination ratchet wrenches: 467BS. 8 - 10 - 11 - 12 - 13 - 14 mm
- 10 sockets, 1/4": R. 5.5 - 6 - 7 - 8 - 9 - 10 - 11 - 12 - 13 - 14 mm
- 1 extension bar 1/4" length 55 mm
- 2 adaptors for 10 mm wrench to 1/4" drive and 10 mm wrench to hex bits, 1/4": 467.ADAPT10MM
- 20 bits: ES. 4.5 - 6.5 - 8 mm EP. 1 - 2 - 3 ED 1 - 2 - 3 EXR 10 - 15 - 20 - 25 - 30 - 40
- EH 3 - 4 - 5 - 6 - 7 mm
- Dim. (L x D x H): 210 x 133 x 59 mm
- Box and foam storage Mbox, small size

467BS.BOX

£272.27

SET OF "11-IN-1" RATCHET WRENCHES



"11-in-1" set, ultra light-weight:

1 wrench + 9 rings = 11 sizes

"11-in-1" maintenance box

- Ideal for areas with low accessibility in terms of height
- Compact and reversible ratchet mechanism using lever
- Up to 5° offset angle
- Dim.: 8 - 9 - 10 - 11 - 12 - 13 - 14 - 15 - 16 - 17 - 19 mm
- Dim. (L x D x H): 265 x 235 x 45 mm



464.J1

£80.77

RATCHET RING WRENCHES

2 wrenches = 8 sizes

practical



Always have the right wrench to hand!
4 sizes in just 1 wrench: ideal for mobile maintenance and on-site jobs.

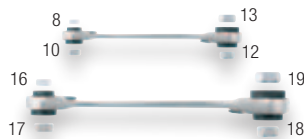

NEW

The range is expanding:

2 new wrenches = 8 additional sizes, available individually:

• 64C.S0:

4 - 6 - 5 - 7 mm

• 64C.S3:

12 - 14 - 13 - 15 mm

Ask your distributor



Set of 2 ratchet ring wrenches

- 64C.S1 = 8 - 10 - 12 - 13 mm
- 64C.S2 = 16 - 17 - 18 - 19 mm

64C.J2

£61.75

RATCHET RING WRENCHES, 15° END

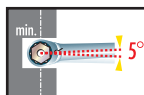

Compact • Practical

Set of 6 ratchet ring wrenches, head angled at 15° over case

- 65. 8 x 9 - 10 x 11 - 12 x 13 - 14 x 15 - 16 x 18 - 17 x 19



x6

65.JP6

£190.59

ANGLED SOCKET WRENCH

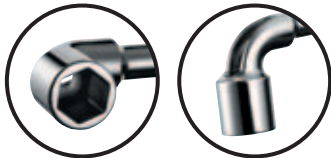

x9

Set of 9 OGV® hex angled socket wrenches
• 8 - 10 - 11 - 12 - 13 - 16 - 17 - 18 - 19 mm

75.J9

£46.04

x12

Set of 12 OGV® hex angled socket wrenches
• 7 - 8 - 10 - 11 - 12 - 13 - 16 - 17 - 18 - 19 - 22 - 24 mm

75.J12

£237.36

101 ADJUSTABLE WRENCHES



Bi-material comfort grip quick adjust adjustable wrench

- Quick Adjustment screw
- 1. Pinching the screw = instant release of the lower jaw
- 2. Use your finger to adjust the size required
- 3. Use the worm to fine tune the adjustment
- Wide jaw opening: Capacity of the Jaw is 15% wider than our standard range
- Can be tethered
- Bi-Material Handle: Increased comfort, place more torque with less effort. More grip/No slip
- Offset angle for accessibility
- Metric and Imperial scale

	Range mm	Length mm	
8"	33mm	201mm	101.8G £23.69
10"	38mm	255mm	101.10G £30.58
12"	41mm	301mm	101.12G £44.10
15"	50mm	376mm	101.15G £71.78

COMPACT VARIABLE OPENING WRENCHES

MAX. opening up to 41 mm



XL

EXTRA-LOW storage requirements

- 46%

MAXIMUM ACCESSIBILITY

- 46% shorter, 40% narrower head for a larger range of opening.

MILLIMETRIC GRADATION

- Enables pre-adjustment of the jaw opening.

LIGHT-WEIGHT

- Featherweight (70% lighter).

COMFORT

- FACOM ergonomic handle.

HIGH PERFORMANCE

- Longer service life.
- 2 models, 6" and 8" with 10" and 12" wrench openings.

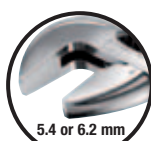

5.4 or 6.2 mm

ACCESSIBILITY

- 40% narrower.



PRACTICAL

- Millimetric graduation for pre-adjustment.

Accessibility • Lightweight • Comfort



6" compact variable opening wrench

- Range 34 mm
- Length 160 mm

113AS.6C

£26.38



8" compact variable opening wrench

- Range 41 mm
- Length 205 mm

113AS.8C

£30.87

INSULATED SCREWDRIVERS 1000 VOLTS *Protwist*[®]

Set of 4 Borneo screwdrivers for mixed cavities

Borneo[®]

Content:

- 1 x 100 VE • 2 x 125 VE
- 1 x 100 VE • 2 x 125 VE

- Mixed cavity suitable for electrical equipment: Contactors, relays, circuit breakers, housings, terminals
- More powerful screws = safety
- Less slippage = better impression, less wear
- Increased useful life of the screwdriver

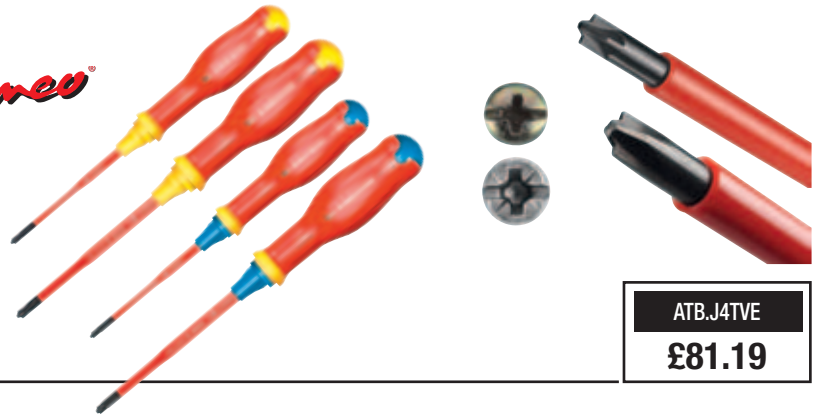

ATB.J4TVE
£81.19

Set of 5 insulated screwdrivers

These screwdrivers are designed for electricians who need 100% accessibility and safety, without having to work with reduced blade insulation

Specifications:

- European Standard IEC 60900
- 1000Vac to 1500 Vdc

Set of 5 insulated 1000V slotted head/PH Slim Blade SCREWDRIVERS

Contains:

- 3.5 x 100 TVE
- 4 x 100 TVE
- 5.5 x 125 TVE
- 1 x 100 TVE
- 2 x 125 TVE

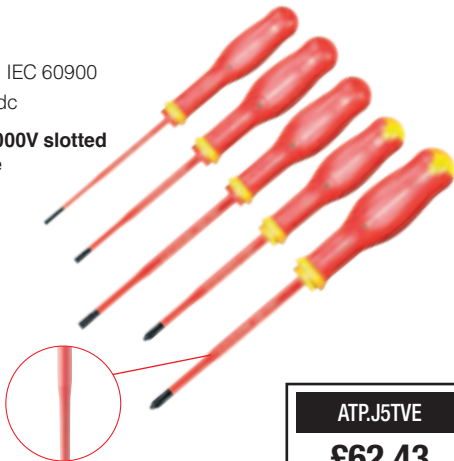

ATP.J5TVE
£62.43



1000VOLTS
EN 60900

Set of 5 insulated 1000V slotted head/PZ Slim Blade screwdrivers

Contains:

- 3.5 x 100 TVE
- 4 x 100 TVE
- 5.5 x 125 TVE
- 1 x 100 TVE
- 2 x 125 TVE



ATD.J5TVE
£62.43

Set of 6 insulated screwdrivers 1000V

Contains:

- 2.5 x 75 TVE
- 3.5 x 75 TVE
- 4 x 100 TVE
- 5.5 x 125 TVE
- 1 x 100 TVE
- 2 x 125 TVE



ATPVE.J6
£55.34

Set of 6 insulated screwdrivers 1000V

Contains:

- 2.5 x 75 VE
- 3.5 x 75 VE
- 4 x 100 VE
- 5.5 x 125 VE
- 1 x 100 VE
- 2 x 125 VE



ATDVE.J6
£69.32

Electrical screwdriver low voltage

- Wide safety guard: 5 mm
- Pilot light
- Transparent handle

AV.HT2C:

- Blade length: 65 mm
- Voltage/V : 110 - 250
- VDE-GS approved



AV.HT2C: Model with clip

AV.HT2C
£5.15

STRIPPING / SHEATH STRIPPING / CUTTING



SWINGO® automatic stripper

- 2 functions in 1: cutting – stripping
- Range 0.02 to 10 mm²
- Multiple and profiled cutting blades
- Integrated cutting function
- Play take-up mechanism for smooth and effortless stripping
- Ergonomic body in nylon glass-fibre
- "Soft" sheathing on the sleeves



793936
£91.45



Pulling tools with hooked swivel blade

- Ergonomic, "reduced effort" push button
- Easily accessible adjustment wheel
- Hooked blade Ø 28 mm
- Spare blade included in the handle

985956
£16.59



Knife with 2 blades

- Electricians knife with blades suitable for working on cabling
- Lock-back for each blade
- Blades hollowed out for better resistance
- Ergonomic handle



640180
£42.62



ACCURACY

- Set the pressure of the jaw on the insulation using the selector.

QUICK TO SET & VERSATILE

- Patented cassettes: removable, adjustable and easily interchangeable.
- Adjustment of the length of the strip from 3 to 18 mm.



COMFORT

- Intended for better comfort during extended and repetitive use at the workplace.
- Soft lining of the handle: comfortable for hands.
- Pistol grip: for stripping on a workbench without excessive support placed on elbows or wrists.

PISTOL GRIP FOR ADDED COMFORT

- Rapid cutting, precise stripping.
- Special intense work, production.



STRIPPING

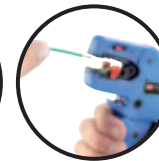

CUTTING

SWINGO® automatic ergonomic stripper

- 2 functions in 1: cutting – stripping
- Range of 0.02 to 10 mm²
- Multiple and profiled cutting blades

793940
£102.79

MULTIFUNCTION SHEATH-STRIPPER 3-IN-1



The indispensable tool for quick, good and problem-free sheath stripping!

SHEATH STRIPPING



Adjustment of the blade by using the wheel



Ease of stripping: 30% less effort with the trigger system



Speed and ease of use: position the sheath-stripper. Turn around the cable. Pull outwards.



CUTTING

Cutting blade out → trigger locked. Lock back blade.



STRIPPING



- Strip rounded PVC cables of Ø 4 to 28 mm
- **DOUBLE SAFETY:** trigger locked when the cutting blade is out and lock-back for blade

872271
£48.62

CRIMPING PLIERS - ALL-IN-ONE

NEW



THE MOBILE SOLUTION

- Easy to use
 - Lightweight
 - No dies
- = save time



ANTI-SLIP MATERIAL

- Comfortable and ergonomic handles: tool does not slip in the hand.

LIGHTWEIGHT

- Easy to use and transport.
- Compact and lightweight: tool designed for easy access in confined spaces

RATCHET

- Equipped with a ratchet system to guarantee good crimping

ECONOMIC

- Requires no other matrix.
- The connector automatically adapts to the size

HOLES

- To attach to a safety belt

RESTRICTED HANDLE OPENING

- Excellent for small hands. Perfect size for women and left-handed people.

985905

£204.82

MOBILE CRIMPING TOOL

PRACTICAL

- Option to organise the dies in 2s
- Type of cavity visible without manipulation

EASY REPLACEMENT

- Easy laying/removal of crimping dies for quick and simple use. No need for tools.

Mobile crimping tool with 4 interchangeable dies

- For the crimping of mechanical, electrical and electronic connectors
- Perfectly positions the wire in the terminal
- Die release system for easy die changing
- 4 interchangeable dies:
 - Die 821461 (mm²): 0.25-0.75, 1-1.5, 2.5, 4, 6, 10
 - Die 821462 (mm²): 0.5-1.5, 1.5-2.5, AWG 22-16, 16-14
 - Die 821466 (mm²): 0.14-1, 1.5, 2.5, 4, AWG 16, 14, 26-18, 12
 - Die 821469 (mm²): 0.5-2.5, 4-6, AWG 22-14, 12-10



COMFORT

- Total visibility of crimping.
- Ergonomic grip and handle designed for operating with one hand for easier crimping.

RELIABLE

- Reliable and accurate crimping with simultaneous action

819832

£364.65

INDUSTRIAL ELECTRICAL MAINTENANCE

Hydraulic crimping tool with trigger

- Power: 35 kN
- Distance: 5 - 8 mm
- 360° rotating head
- For crimping tubular and sleeve terminals
- To be used with hexagonal dies



Hexagonal crimping dies

- For hydraulic crimping tool 985913 below
- Crimping conforms to standard NFC20130

6 mm ² > 985914	50 mm ² > 985919
10 mm ² > 985915	70 mm ² > 985920
16 mm ² > 985916	95 mm ² > 985921
25 mm ² > 985917	120 mm ² > 985922
35 mm ² > 985918	150 mm ² > 985923

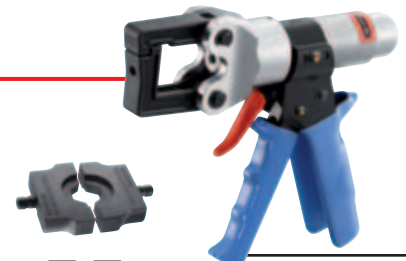

985913

£724.27

CRIMPING PLIERS

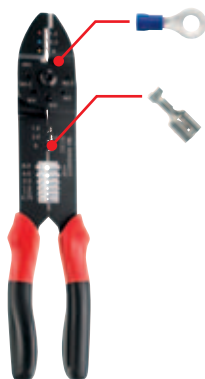

Standard crimping pliers

- Integrated wire cutting function
- Crimping for insulated terminals: Ø 1.5 to 6 mm²
- Crimping for stripped terminals: Ø 1.5 to 6 mm²
- Stripping: Ø 0.75 to 6 mm²
- Strip cutting, fine sheets: 4 mm
- Copper wire cutting up to 6 mm in diameter
- Length: 225 mm

449B

£38.91

RATCHET CRIMPING PLIERS

For insulated terminals with positioner

- Second hand free to position
- Dies with 3 cavities (mm²): (0.5 - 1.5) - (1.5 - 2.5) - (4 - 6)
- Maintenance of the terminal and wire after crimping
- Maintenance of the terminal by the positioner before crimping using the '3rd hand'
- Crimping traction resistance according to standard IEC 760
- Length: 230 mm



0.5 to 6 mm²

673838

£86.93

For cable tips

- Dies with 5 cavities (mm²): (0.5 - 0.75) - (1 - 1.5) - 2.5 - 4 - 6
- Crimping traction resistance according to standard NFC 63-023
- Length: 230 mm



0.5 to 6 mm²

985895

£86.93

CONTACTLESS AMMETER

NEW

Works with FACOM multimeters, type 711, 714, etc.

Manual zeroing

Industrial and automobile use

- AC/DC: 20 A - 400 A
- AC/DC: 400 A - 1 500 A



Permitted diameter Ø 53 mm

FACOM Design

For industrial and automobile use

- Allows contactless measurement of current
- Measurement of alternating AC current and direct DC AC/DC: 20 A - 400 A
- AC/DC: 400 A - 1 500 A
- Diameter of the jaws: 53 mm
- Maximum permitted diameter of 52 mm cable
- IV Category - 600 Volts
- Compatible with multimeters capable of measuring mV

720.P1500

£168.41

SAFETY MULTIMETRES AND TESTERS

- *Conforms to standards NF EN 61010-600V cat III and IEC 61243-3 (VAT/DDT)*
- *Used to check the absence of "VAT" voltage, phase detector, continuity tester, 30mA circuit breaker test, phase rotation indicator*

DDT/VAT safety testing

- Auto test
- Voltage multi-tester
- Neutral phase tracking
- Continuity test
- 30 mA differential circuit breaker test
- Spacing of probe tips at 19 mm for quick testing of European sockets
- Test-lead point set 701B-L (separate item), non-fusible



701B

£123.14

- *Contactless measurement of current: no risk of short circuit in case of misuse*
- *AUTO calibration, LCR back-lit screen, resistant to harsh environments*
- *Measurements: 600V CAT III*

Multimeter pliers

- Voltmeter: AC/DC from 0 to 600 V
- Ammeter: AC/DC from 0 to 400 A
- Ohmmeter: 0 to 20 MΩ
- Continuity test
- Diode test < 50' Ω
- Comes with a protective cover and a pair of probe tips (711A-L)



712A

£513.68

SOLDERING IRONS

Stand-alone soldering iron

- Equivalent to 75 watts power
- Adjustable flow and power
- Maximum temperature 1 300°C
- Piezo system ignition
- Heating time: 40 sec
- Refillable with gas butane (iron delivered empty)



1075.H

£123.31

Bi-watt soldering iron

- Double insulation
- Normal heating: 15 W for minor soldering
- PVC 2-conductor cable (2 x 0.75), 1.2 m in length
- Additional 40 W power by pressing the button
- 10 A European plug
- Shipped with standard tip and black stand



Ideal for electrical and electronic maintenance

1116C.BW

£82.40

9 CAVITY CROSS BRACE

Ideal for industry or construction maintenance environments

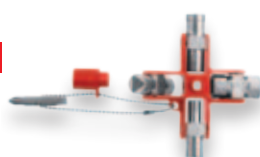

- 9 cavities in a light, compact and handy tool:

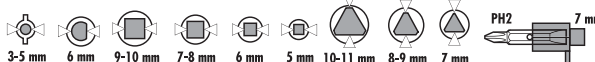

- 1 bit with 2 screwing cavities linked to the wrench by a removable chain: □ 7 mm ⚡ No.2

838305

£90.18

STAINLESS STEEL KNIVES

RUSTPROOF

- Stainless steel blade 12C27
- 100% stainless steel components

QUICK

- "One hand" opening thanks to the wheel

USEFUL

- Eyelet for strong and effective hanging

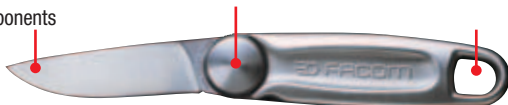

SECURE

- "Liner lock" locking system

PRACTICAL

- Leather case offers complete freedom of movement, thanks to its horizontal design

COMFORTABLE

- Manufacturing that draws on aviation technology and developed by FACOM to guarantee you an optimal grip

Stainless steel knife with wheel

- Supplied with a leather belt holder
- Length of blade: 73.5 mm - total length: 189 mm

840LE

£190.47

KNIFE WITH LOCK-BACK BLADE



Pocket knife

- Polished stainless steel blade
- Bi-material handle
- Quick one-handed opening
- Tip at the end of knife: windshield cutting functionality
- Safety: lock-back blade
- Length of blade: 77 mm
- Length when closed: 115 mm
- Total length: 186 mm
- Delivered in a nylon case for hanging on belt

840.F

£45.31

UNIVERSAL CUTTER

Opening range 36 mm



"Universal" multi-use cutting shears

- Clamping system when in closed position
- 2 positions: small and large hands
- Bi-material covering
- Allows cutting of: plastic, strips, fine sheets, nylon, leather, rubber, etc.

980

£20.78



"Universal" multi-use cutting shears with open blade

- Open blade to facilitate the position of the hand when cutting long lengths
- Hand remains positioned above the top of the cut and does not go over the material

980C

£20.78

BI-MATERIAL SCISSORS - HEAVY DUTY

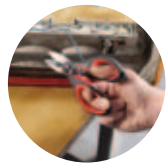

Heavy duty shears

- Entire structure made from steel (blades + handles)
- Bi-material covering over the handles
- Crimping component
- Cable cutter Ø 50 mm on both blades
- Stripping groove
- Delivered in case equipped with a belt clip

841A.3

£41.54

CUTTERS



Recommended by CHSCT

Safety knife

- Auto-retractable
- Supplied with 3 "trapeze" blades

844.D

£26.86



Cutter 9 mm with snap-off blades

- Autolocking of blade
- Storage for 2 blades in the handle

844.S9

£6.17



Cutter 18 mm with snap-off blades

- Blade locking wheel
- 6-blade cartridge for automatic loading

844.S18

£12.26

SNAP-OFF BLADES

Ideal for all daily cutting applications



Case of 10 snap-off 9 mm blades

- 12 segments

844.S9L10

£3.52

Case of 10 snap-off 18 mm blades

- 7 segments

844.S18L10

£5.12

METAL SHEARS

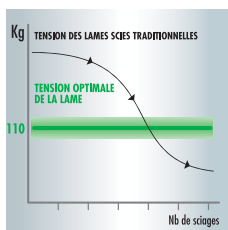

Automatic tension control

OPTIMAL AND HARD-WEARING CUTTING

- Constant tension of blade: 110 kg, automatically controlled
- Rigid aluminium frame

ERGONOMIC HANDLE

- Bi-material, vibration reduction

SAVE TIME

- Ultra-fast changing of blades

"High performance" hacksaw frame

- Aluminium frame
- Cutting capacity of 100 mm over the entire length of the frame
- 8 cutting positions (every 45°)

⚖️ 0.830 kg

603F

603F

£68.58

Check out the video of our production site



601

Light and compact

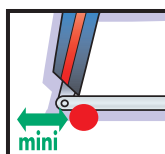

Minimal unused space to attack the cut

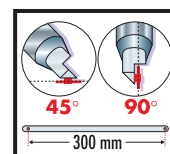

2 blade positions on machined and supported axes

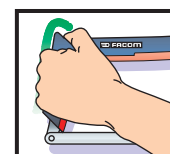

Left hand rest

Compact hacksaw frame

- Metal-resin anti-shock structure
- Blade tension 80 kg
- Dimensions: 385 x 145 mm

⚖️ 0.670 kg

601

£27.70

BI-METAL HSS SAW BLADES

Increased service life

Superior heat resistance



Box of 100 blades 8 teeth

- For thick semi-hard steel
- Recommended thicknesses: 6 - 25 mm

668A.8

£2.38

Box of 100 blades 10 teeth

- For special steels and alloys
- Recommended thicknesses: 3 - 6 mm

668A.10

£2.38

Box of 100 blades 12 teeth

- For stainless steel, copper
- Recommended thicknesses: 1 - 3 mm

668A.12

£2.38

RIVETING PLIERS



Riveting pliers

- Return spring
- Key for tightening the integrated openings
- Capacity:
 - Ø 5 mm aluminium rivets
 - Ø 4 mm steel rivets

Y.103B
£37.70



"Hard-wearing" riveting pliers

- New nose with an insert for great durability
- Return spring
- Supplied with 3 openings and quoin key
- Capacity: Ø 5 mm aluminium Ø 4 mm steel

Y.104
£67.52



"2 hand" riveting pliers

- Recovery of broken nails
- "Comfort" grips
- Capacity: up to Ø 6.4 mm all materials
- Supplied with 4 openings for Ø 4 - 5 - 6 - 6.4 mm

Y.116B
£149.55

STAGED DRILL BITS

Staged drill bit ISO

- 11 stages ISO: Ø 6.5 to 40.5 mm
- Drilling of sheets up to 4 mm
- Length: 96 mm
- Ø tail: 10 mm



Drilling of sheet metal up to 4 mm thickness

678006
£136.36

Staged drill bit PG

- 12 stages PG: Ø 6 to 37
- Drilling of sheets up to 4 mm
- Length: 100 mm
- Ø tail: 10 mm



678014
£136.36

AXIAL BOLT CUTTERS

Capacity: up to 160 kg/mm²

- Capacity: up to 160 kg/mm² - longevity of cut
- High performance chrome blades - reduced cutting effort
- "Comfort" grip handle - forged or tubular arms

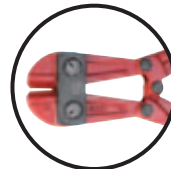

FORGED ARMS

- Better resistance
- Less bending in the arms when cutting

TUBULAR ARMS

FORGED ARMS

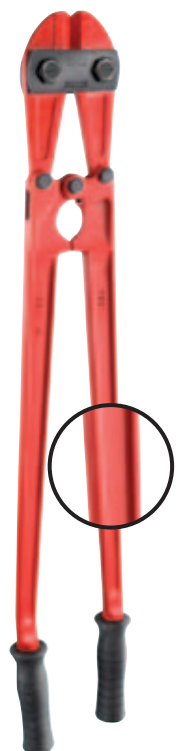

Blades No.	max. in mm			Length mm		
	60 kg/mm ²	140 kg/mm ²	160 kg/mm ²		TUBULAR ARMS	FORGED ARMS
0	7	6	5.5	450	990.B0 £61.67	990.BF0 £158.95
1	10	8	7	600	990.B1 £78.63	990.BF1 £199.80
2	13	9	8	750	990.B2 £102.18	990.BF2 £255.31
3	16	10	9	900	990.B3 £124.10	990.BF3 £345.49
4	18	11	10	1050	990.B4 £203.67	990.BF4 £442.62

TAPE MEASUREMENTS **DOUBLE MARKING**

ABS HOUSING MATERIAL



LOCKING BUTTON
with automatic return

WIDE END 2 OR 3 RIVETS

covered with stainless steel reinforcement plate

NYLON TAPE

- Nylon coating
- Printed double-sided for use as ruler



CLIP HOOK BELT

2 m measuring tape

- Dim. Table (L x W): 2 m x 13 mm

893B.213

£9.45

3 m measuring tape

- Dim. Table (L x W): 3 m x 19 mm

893B.319

£11.57

5 m measuring tape

- Dim. Table (L x W): 5 m x 19 mm

893B.519

£13.69

8 m measuring tape

- Dim. Table (L x W): 8 m x 25 mm

893B.825

£16.87

897A MEASURING TAPES **HIGHT PERFORMANCE**

BI-MATERIAL CASING:

Soft coating resistant to shocks and extreme operating conditions.

HIGH QUALITY TAPE:

- Highly durable Mylar coating, anti-reflection matte finish.
- Extra rigid tape up to more than 3 m.

WIDE END 2 OR 3 RIVETS

covered with stainless steel reinforcement plate.

STAINLESS STEEL BELT CLIP

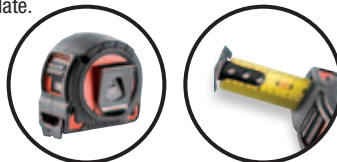

3 m measuring tape

- Dim. Table (L x W): 3 m x 19 mm

897A.319

£14.61

5 m measuring tape

- Dim. Table (L x W): 5 m x 28 mm

897A.528

£18.07

8 m measuring tape

- Dim. Table (L x W): 8 m x 28 mm

897A.828

£22.11

MEASURING TAPE **STAINLESS STEEL CASING**

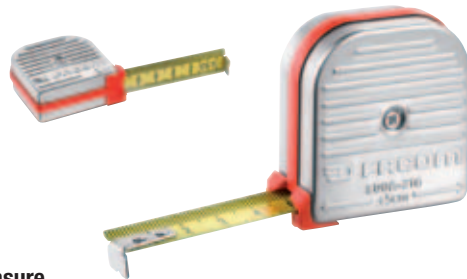

Engineers tape measure

- Compact
- Self-return system by simple placement of the hook on a surface
- Length: 2 m - Width: 16 mm
- 2 rivet tape
- Rigid up to 1.10 m

800A.216

£18.60

METROLOGY

Watertight IP 65 • Transmission software



Digital callipers 150 mm

- Standard DIN 862
- Resistant to water and workshop oils
- RS 232 output
- Automatic stop
- Digital LCD 6 mm display
- Mechanical rectified stainless steel
- Flat depth gauge
- Supplied with certificate of compliance

1300

£59.98

WIRED PROJECTOR

NEW

Control the lighting in your workshop from your mobile

BLUETOOTH® FUNCTIONALITY

Range up to 20 m

Free application



FACOM DESIGN



180° ROTATION 360° PIVOT FUNCTION



MAGNETIC BASE

Base with detachable magnet for hands-free use

- Bluetooth® functionality:
 - Up to 5 projectors can be connected on the same mobile telephone
 - Adjustment of light intensity of each lamp independently carried out
- 5 levels of brightness: 2000 / 4000 / 6000 / 8000 / 10 000 lumen
- IP67 watertight case. Shock resistant IK07
- Contrast and natural lighting: colours true-to-life (IRC85)
- Power cable: 5 m
- Compatible with FACOM 779.TRIPODUK tripod (optional)
- Dimensions (L x W x D): 320 x 150 x 260 mm
- 3,000 kg

777.SPOTBTUK

£334.75

ADJUSTABLE TRIPOD



- Sold as stand-alone, compatible with spotlights, 779.EYEUK, 777.SPOTUK, 777.SPOTBTUK
- Dimensions folded (L x D x H): 100 x 100 x 780 mm
- Max floor space required (L x D): 770 x 770 mm
- Max. height : 2.0 m
- 4,600 kg

779.TRIPODUK

£83.81

HIGH PERFORMANCE

- 3 power levels
- Wide surface of constant lighting over the entire area
- Contrast and natural lighting: colours true-to-life (IRC83)
- 180° rotation
- 360° pivot functionality (777.SPOTUK only)



HIGH RESISTANCE

- Casing resistant to IK07 and watertight IP67
- Base magnet for hands-free use, with 3/8" insert for use on tripod (779.TRIPODUK optional)



Rechargeable 1 500 LUMENS

- Power levels:
 - ECO > 500 lumen for 8h operation
 - NORMAL > 1 000 lumen for 4h operation
 - BOOST > 1 500 lumen for 2h45 operation
- Dimensions (L x W x D): 175 x 80 x 125 mm
- 0.760 kg

779.EYEUK

£206.88

Wired 5 000 LUMENS

- - 360° swivel
- Power levels:
 - ECO > 1 500 lumen
 - NORMAL > 2 500 lumen
 - BOOST > 5 000 lumen
- Dimensions (L x W x D): 320 x 150 x 260 mm
- Power cable: 5 m
- 3.000 kg

777.SPOTUK

£244.01

INSPECTION LAMPS

Wireless LED inspection lamp

THE LAMP YOU WON'T LOSE!

“FIND MY LIGHT” TECHNOLOGY:

- The user is alerted when the lamp is lost, when the lamp is out of reach of its base (adjustable range up to 30m) or when the lamp has only 10 minutes of remaining charge time left
- Your charger tells you if your lamp leaves the workspace. Use your charger to locate your lamp

PRACTICAL:

- The 360° suspension hook and magnetic base allows the lamp to be used in hands-free mode
- Pivoting optics: 6 positions
- Personalisation: delivered with a personalisation patch for the lamp and charger base

ACCESSORIES:

- Delivered with charger base, cable and personalisation patch
- Option to have different personalisation patches
- 2 power levels of lighting:



- **Normal:**
6 hours of autonomy, 300 lumen
- **Boost:**
3 hours of autonomy, 600 lumen
- Water and dust resistant housing (IP 67)
- 1/4» thread
- Shock-proof housing (IK 08)
- Lamp can be rotated through 200°
- Suspension hook can be rotated through 360°
- Magnet

ON/OFF AT THE BACK

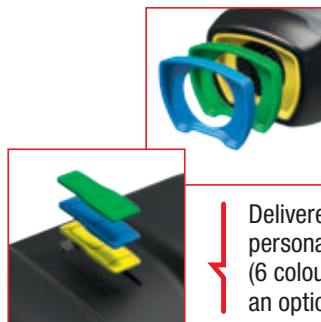

Delivered with a personalisation patch (6 colours available as an option: 779.CL56)

779.CL5

£287.37



Slim cordless inspection lamp

KG 0.160 kg

- 3 power levels:
 - 400 lumen and autonomy of 8 hours
 - 250 lumen and autonomy of 17 hours
 - 40 lumen and autonomy of 40 hours
- LCD battery level indicator
- Water and dust resistant housing: IP67
- Practical:
 - 2 magnets (on the back)
 - 2 hooks, one of which rotates (360°)
 - Micro USB. Standard socket

ACCESSORIES INCLUDED:

- USB charging cable
- USB mains charger

HOOKS AND MAGNETS

The “slim” design provides maximum accessibility in confined and cramped spaces



779.SILR2

£99.00

LED HEAD LAMP

NEW

Motion sensor technology



- Technology Motion sensor : lamp switches on when passing a hand in front of the lamp
- Powerful light output
- Easy to use
- Long-lasting operation, up to 16 h
- On/Off button underneath the lamp
- Adjustable head
- Works with 3 AAA batteries (supplied)
- Watertight: IP 54
- 2 MODES:
 - 50 lumen mode "NORMAL" (up to 16h operation)
 - 200 lumen mode "BOOST" (up to 4h operation)

779.FRT2UK

£51.98

" POCKET " LED LAMP

The most powerful hands-free lighting

ENHANCED PROFESSIONAL PERFORMANCE

- Microprocessor for managing charge/discharge: constant lighting, operation 5h30, charge 2h30
- Optical LED, high performance: wide lighting area, 75 lumen.
- High resistance to shocks and workshop solvents, as well as splash proof (certified IP55)

EASY AND QUICK TO MOUNT

- Innovative clamp hook
- Powerful removable magnet
- Flexible allowing movement over all levels (360°)



- Comes with a rechargeable Lithium-Ion battery
- Supplied with 230 V charger, 2 m power cable and cord hand strap

779.PCAUK

£79.57

FLUORESCENT 24 V INSPECTION LAMP



- Long-lasting, powerful lighting
- 11W fluorescent tube: does not heat up
- Anti-glare
- 470 Lux at 0.5 m
- 320 lumen
- Rubber cable HQ5 RN-F: good resistance to hydrocarbons
- Length of cable: 10 m
- Sealing classification IP55
- Also available with drum, ref. 777A.24F

777B.24F

£168.68

LED TORCHES



More than 50h of operation

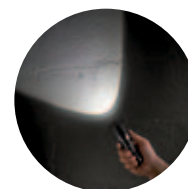
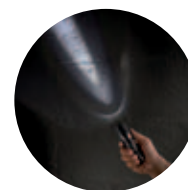

Compact torch

- 1 LED 3W
- Adjustable light beam
- From 43 to 309 lumen by choosing the desired beam
- 39 601 lux at 0.5 m at max. opening
- Maximum lighting distance: 233 m
- 5 lighting modes
- Maximum operation time: 51.5 hours
- Sealing classification: IP65
- Supplied with: 4 AAA batteries, strap and protective case

779.CBT

£94.41



Rechargeable

Ultra-powerful

Compact rechargeable light

- 1 LED 10W
- Adjustable light beam
- From 175 to 814 lumen by choosing the desired beam
- 34 225 lux at 0.5 m at max. opening
- Maximum lighting distance: 185 m
- Maximum operation time: 18.5 hours
- Charge time: 6 hours
- Sealing classification: IP65
- Li-ion rechargeable battery
- Chargeable via USB
- Supplied with 230 V charger, USB power cable, hand strap and protective case

779.CRT

£155.48



UV lamp

- 1 LED 1W UV
- From 395 to 410 nm
- Operating time: 23 hours
- Maximum lighting distance: 50 m
- Sealing classification: IP67
- Supplied with: 3 AAA batteries, strap and protective case



779.UVT

£94.41

PEN LAMPS

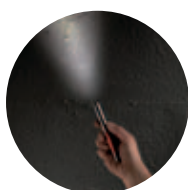

Pen torch

- 1 LED 3W
- 110 lumen
- 2304 lux at 0.5 m
- Maximum lighting distance: 48 m
- Operating time: 3.5 hours
- Sealing classification: IP65
- Supplied with: 2 AAA batteries, hand strap

779.PBT

£47.23



SIZE/POWER RATIO = EXCEPTIONAL!

- Compact lamp with wide, powerful lighting as a result of 6 LEDs 36 lumen, 100 lux at 1 metre and 8h operation if continuously on

PROFESSIONAL QUALITY

- High shock-resistance
- IP54 splash-proof

EASY TO MOUNT

- Clip to attach to pocket
- Fixing magnet

- Supplied with 3 AAA batteries

779.PEN

£34.02

INTERIOR/EXTERIOR EXTRACTORS

U.306

Auto clamping Auto centring

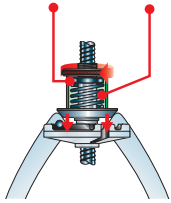

VERSATILE

- 2 or 3 pullers for assembly
- Easy-change pullers

EASY TO USE

- Self-locking pullers
- Self-centring screw



Extraction capacity 140 mm

- Capacity: Exterior: Ø 7 to 140 mm Interior: Ø 23 to 130 mm
- Supplied with 1 set of 3 outside pullers and 1 set of 3 inside pullers

7 - 140MM	U.306A140 £191.71
50 - 170MM	U.306-180 £248.9
20 - 260MM	U.306-260 £299.12

Easy transformation
from outside to inside

SAFETY
Fuse screw head

TOTAL LOCK
of pullers using wheel

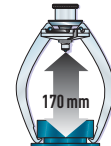
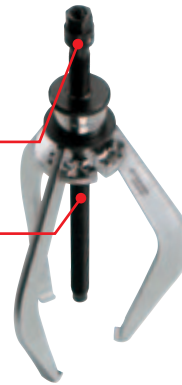

Extraction capacity 180 mm

- Capacity: Exterior: Ø 11 to 180 mm Interior: Ø 50 to 170 mm
- Supplied with 1 set of 3 outside pullers and 1 set of 3 inside pullers

U.306-180
£248.90

U.312

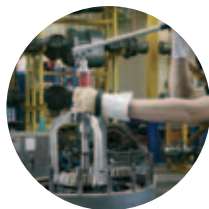

Simple, lightweight and compact!

Set of outside pullers	Range mm	Max. scope
U.312G110	45 ▶ 85 mm	110 mm
U.312G160	80 ▶ 170 mm	160 mm
U.312G210	90 ▶ 210 mm	210 mm
U.312G260	110 ▶ 270 mm	260 mm



Hydraulic Extractor 10T, 4 sets of pullers

- Set-up includes:
- Hydraulic 10T jack + guide tip + set of 3 screws/nuts
 - 2 or 3 puller body component + centring screw + set of 3 screws/nuts
 - Supplied in plastic casing
 - Store in JETXL, JET+, Jetline + drawers
 - Capacity 45 to 270 mm
 - Dimensions: 565 x 412 x 105 mm



U.312HJ4
£1,020.61

SET OF THREADING REPAIR INSERTS

Complete set:

- M5, M6, M8, M10, M12 stainless steel inserts.
- Special taps to repair M5, M6, M8, M10, M12 threads.
- Special drill bits to repair M5, M6, M8, M10, M12 threads.
- Mixed tools (mounting inserts and tap wrench) for M5, M6, M8, M10, M12 inserts.
- Magnetic "bit breaker" tools for M5, M6, M8, M10, M12 threads.



TRK5-12
£275.45

SET OF MASTER BEARING RACE AND SEAL DRIVER

Simple, versatile



Impact zone



Adjustment without tool



- 2 multi-diameter tools with adjustable jaws: - Jaws from Ø 9.5 to 50 mm - Jaws from Ø 18 to 90 mm
- 3-Stepped jaws for adjusting all types of seals and bearing races

217.J2
£306.49

SAFETY SOLUTIONS THAT ARE INTELLIGENT, WHATEVER YOUR JOB



NEARLY 100 YEARS OF INNOVATION SERVING THE INDUSTRY

Today, safety and productivity are at the heart of concerns in all trades in the industrial sector. For the aerospace industry alone, the annual financial impact of Foreign Object Damage (FOD) is estimated at \$13 billion, with indirect costs often higher than direct costs. This is relevant to all sectors because of the risk of equipment and human accidents, interruptions to production, delays in delivery, etc.

**DISCOVER THE
COMPLETE RANGE
IN OUR CATALOGUE,
FACOM SAFETY SOLUTIONS
or at www.facom.co.uk**

RFID SOLUTION



- Clearly detectable tools with a perfectly integrated chip.
- Optimised traceability, significant loss of tools in sensitive areas.
- Automated management of your tools and inventory with RFID Facom-Cribmaster technology.
- A range of more than 700 product references.



Check out our video by scanning this code

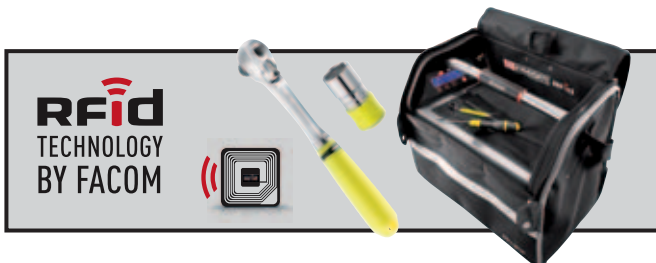

- Detectable using a UV lamp, the Fluo range provides a unique and simple way of identifying your tools in black or dark areas.
- This solution increases safety by reducing the risk of accident associated with the loss of tools.
- This range is available with more than 500 product references.

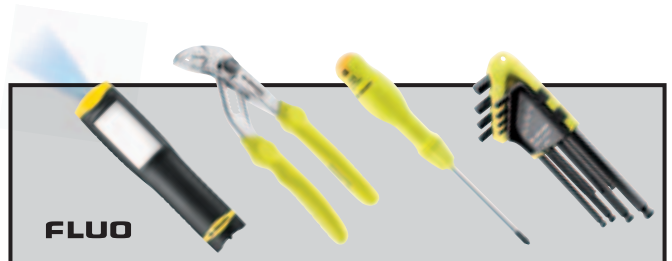

SLS SOLUTION



- Tools specifically designed to preserve the comfort and performance of standard tools in all conditions.
- Facom metal ring system to withstand shocks, stress and extreme conditions.
- Safety Lock System, a range of nearly 300 secure tools.



Check out our video by scanning this code

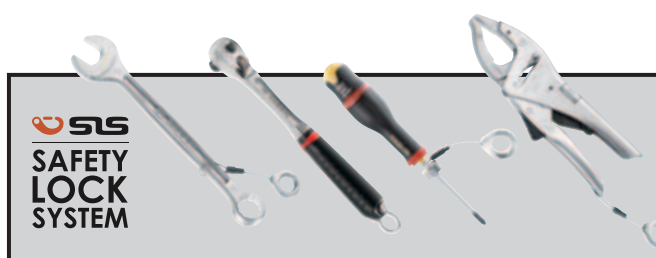

SLS HOOK SYSTEM PACK

100% ANTI-FALL SECURITY

- Transfer from one hand to the other (from your hand to your belt, from one operator to another, etc.).
- Automatic system = no need to press a button.
- Tool attached to the wrist = greater freedom of movement.



The set includes:

- 1 pouch 3 holders SLS HOOK SH-BAG1SLS
- 2 wrist straps SKYHOOK SLS WRT-SHSL
- 3 double hooks SLS HOOK SH-SLS

**SH-SETSLS
£332.81**

CALIBRATION EQUIPMENT

NEW

A complete range for testing and calibrating wrenches

- A new complete range of **E.6000 sensors** covering 0.04 to 1 000 N.m. For advanced control and basic calibration. High level of accuracy: 0.5%. For use in a laboratory or work area. USB cable connection.
- A new **CD.12A manual calibration bench** for all torque wrenches up to 1 000 N.m. Support of standard ISO 6 789 for calibration. Body in aluminium, turntable, and gearbox with 1200:1 ratio, ensuring the linear speed required for compliance with the standard.



- **Software that is** simple, ergonomic and intuitive to check and calibrate wrenches. Two modes: basic mode and advanced mode. It allows manual measurements, guided procedures, tracking and data management to be carried out. Free downloadable software on the FACOM site.

Take a look at www.facom.co.uk
Get in touch with your distributor



TORQUE AND ANGLE

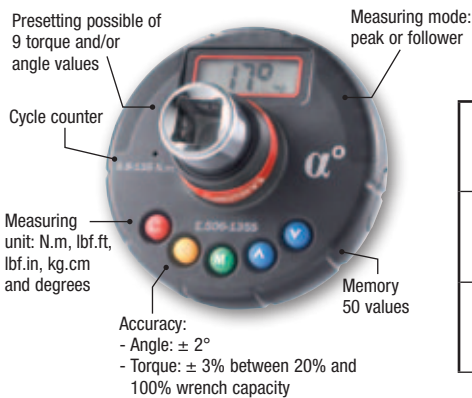

Torque and Angle Adapter 135Nm	E.506-135S £247.86
Torque and Angle Adapter	E.506-200S £273.56
Torque and Angle Adapter 340Nm	E.506-340S £289.64

Torque Angle Adapter 1 - 360 Degree

- Supplied in plastic case with calibration certificate
- Accuracy: $\pm 2^\circ$
- Angular range: 1 – 360°
- Measuring unit: degree, Accuracy: 0,1°
- Presetting possible of 9° angle values
- Memory 50 values



E.406
£169.98

ELECTRONIC SCREWDRIVERS SERIES E.S400

High accuracy for low torque

Screwdriver designed to offer high accuracy while maintaining ease of use. Traceability functions: ideal tool for maintenance in the aerospace, medical, nuclear sectors, etc.



HIGH PERFORMANCE

- Accuracy $\pm 2\%$ between 20% and 100% of capacity, very superior to mechanical screwdrivers and conforms to standard ISO 6789 (6% for torque screwdrivers)
- Electronic measurement: high repeatability without causing a wear effect

TRACEABILITY

- Real tightening torques are transmitted via the USB cable
- 250 torque values can be stored



EASE OF USE

- 9 pre-set torque values
- Choice of measurement units: cN.m, in.lb, Kg.cm
- Sound and visual alarm once the torque is reached
- Ergonomic: Protwist® grip and bit auto locking system

Sets of electronic torque screwdrivers and screwing bits

- Supplied in plastic case and foam tray module
- USB cable included
- Works on one AAA battery – LR03 1.5V (included)
- Supplied with an ISO6789 calibration certificate

NF IN ISO 6789,
ISO 6789,
DIN IN ISO 6789

Capacité N.m Min. - Max.	Tournevis	Emboutis longs	
0,4 > 4	E.S404	<ul style="list-style-type: none"> • 3 - 4 - 5,5 mm • PH1 - PH2 - PH3 High Perf' 	E.S401J1 £624.31
0,1 > 1	E.S401	<ul style="list-style-type: none"> • 3 - 4 - 5,5 mm • PH1 - PH2 - PH3 High Perf' 	E.S404J1 £624.31

TORQUE WRENCHES

Micrometric Vernier scale



POWERFUL

- Factory output accuracy: $\pm 2\%$ supplied with calibration certificate according to standard ISO 6789
- Pivot handle, removable ratchet
- 72 teeth ratchet - 5° offset angle
- Micrometric Vernier scale: legible and accurate

PRACTICAL AND SIMPLE TO USE

Automatic trigger and reset

VERSATILITY

Standard attachments 9 x 12 or 14 x 18

WRENCHES ADAPTED FOR CERTIFICATION

ISO 9000 (series number, calibration certificate)



Ultra compact wrench. Fixed ratchet

	Capacité N.m Min. - Max.	Attachement	Poignée pivot	Grad. Nm	L mm	
□1/4"	1 > 5	Cliquet fixe	-	0,05	197	R.306-5 £315.11

Torque wrenches with removable ratchet

	Capacité N.m Min. - Max.	Attachement	Poignée pivot	Grad. Nm	L mm	
□1/4"	5 > 25	9 x 12	-	0,10	270	R.306A25 £397.26
□1/2"	20 > 100	9 x 12	OUI	1,00	455	S.306A100 £454.99
□1/2"	40 > 200	14 x 18	OUI	1,00	535	S.306A200 £491.32
□1/2"	70 > 350	14 x 18	OUI	2,00	730	S.306A350 £572.89



Extra long torque wrenches

	Capacité N.m Min. - Max.	Attachement	Poignée pivot	Grad. Nm	L mm	
□3/4"	120 > 600	9 x 12	-	2,00	945	K.306A600 £814.67
□3/4"	200 > 1000	9 x 12	-	4,00	1280	K.306A1000 £1,259.78

ELECTRONIC WRENCH WITH TORQUE READING

Very easy to use and very affordable price:

Ideal for use both in the workshop and laboratory

Accurate tightening, control and traceability!

ISO 6789 - DIN EN ISO 6789 - NF EN ISO 6789

ACCURACY

$\pm 2\%$ between 20% and 100% of capacity of the wrench

MEASURING METHOD

peak or tracking

UNITS OF MEASUREMENT

N.m ; ft.lb ; in.lb ; Kg.cm

ATTACHMENTS 9 x 12 or 14 x 18

**NUMBERED WRENCH
SUPPLIED WITH A
CERTIFICATE OF CALIBRATION
ISO 6789**

and plastic tray with inner foam



PC link via USB



	Capacité N.m Min. - Max.	Attachement	Cliquet	Dim.	
□1/4"	1,5 > 30	9 x 12	R.372	390 mm	E.306A30R £606.93
□3/8"	6,7 > 135	9 x 12	J.372V	415 mm	E.306A135J £639.54
□1/2"	7 > 135	9 x 12	S.372V	415 mm	E.306A135S £639.54
□1/2"	10 > 200	14 x 18	S.382V	530 mm	E.306A200S £707.06
□1/2"	17 > 340	14 x 18	S.382V	650 mm	E.306A340S £732.59

A COMPLETE RANGE OF ACCESSORIES FOR TIGHTENING BITS

Our range of accessories covers all your tightening needs:

- Set of various bits:
 - Claw bits mm / inch
 - Crowfoot bits mm / inch
 - Polygonal bits mm / inch
- Sets supplied in a plastic box with foam tray insert.



**FACOM
laboratory
accredited by
cofrac**

ACCREDITATION NO.2
1934
Range available on
www.cofrac.fr

1/2" IMPACT WRENCH

Powerful striking system

LED lighting
trigger activated:
removable and
rechargeable
(except NS.3100G)

Progressive trigger
for better control

One hand operation of reverser
with two levels of clamping power
and full power on loosening



	NS.3500G	NS.2500G	NS.3100G
No-load speed	6500 rpm	10000 rpm	7000 rpm
Maximum torque	1900 Nm	1010 Nm	1600 Nm
Impacts/min.	1200	1400	1300
Pipe diameter	1/2"	1/2"	1/2"
Length of	162 mm	144 mm	162 mm
Weight	2.2 kg	1.4 kg	2 kg

NEW

1/2" HP impact wrench 1900 Nm

- Maximum torque: 1900 Nm
- No-load speed: 6500 rpm
- Impacts/min. : 1200
- Length: 162 mm

2.2 kg



NS.3500G

£757.05

1/2" compact HP impact wrench 1010 Nm

- Maximum torque: 1010 Nm
- No-load speed: 10000 rpm
- Impacts/min. : 1400
- Length: 144 mm

1.4 kg



NS.2500G

£465.56

1/2" impact wrench 1600 Nm

- Maximum torque: 1600 Nm
- No-load speed: 7000 rpm
- Impacts/min. 1300
- Length: 162 mm

2.0 kg



NS.3100G

£378.73

1/2" compact impact wrench 861 Nm

- Maximum torque: 861 Nm
- No-load speed: 10000 rpm
- Impacts/min. : 1650
- Length: 111 mm

1.2 kg



NS.1600F

£171.25

IMPACT WRENCH \square 1" SHORT ANVIL

High performance

3390 N.m



Impact wrench \square 1" Gun-type

- Dual hammer mechanism with an exceptional torque of 3390 N.m.
- Two levels of clamping power and full power on loosening
- Rubber bumper protecting the motor housing.
- Lightweight, only 6.9 kg without compromising power.

6.890 kg

NM.3000F

£924.67

High performance

3390 N.m



Impact wrench \square 1" Straight

- Dual hammer mechanism with an exceptional torque of 3390 N.m.
- Rubber bumper protecting the motor housing.
- Lightweight, only 8 kg without compromising power.

8.070 kg

NM.3030F

£924.67

SET OF 9 IMPACT SOCKETS \square 1/2" ON RACK



- Including sizes: 13 - 14 - 16 - 17 - 18 - 19 - 21 - 22 - 24 mm

NS.J9PF

£41.39

2" ANGLED CUT OFF TOOL



Cut Off Tools

- Miniature size for tight spaces
- Features low noise technology
- Cushion grip to reduce vibration
- Safety lock for swivel guard
- Rotating air inlet
- Side exhaust
- Safety throttle lever

Uses COW213238
2" "Cut-off Wheel."

V.CA50F

£149.00

AIR HAMMER KIT



Short Barrel
Hammer
with 5 Blades

V.331AH

£243.43

Air Hammer

- Ideal for cutting panels, paint stripping and welding traces.
- Quick and easy change device for front and rear shock absorbers in polyurethane reducing vibrations for better ease of use.
- Progressive trigger for optimum speed control.
- Center of gravity on the trigger and the handle for the comfort of the user.



Long Barrel
Hammer
with 5 Blades

V.336AH

£275.43

GRINDERS 0.5 CV COMFORT WITH 6 MM RETAINER

HIGH PRECISION GRINDER with 6 mm retainer
DURABLE AND POWERFUL MOTOR ,0.5 CV, for high productivity
MOULDED "SOFT GRIP" HANDLE in rubber, insulates against cold and vibrations.
SPEED CONTROL is easy to adjust to limit speed.

AIR BLOWN AWAY at back to avoid projections on the operator.
BUILT-IN SILENCER and option to attach air exhaust pipe to lower noise levels.
EXCELLENT CONTROL with progressive trigger to control speed.



Straight 0.5 CV comfort grinder

- Length: 177 mm
- 0.675 kg

V.DG500F

£172.06



Straight 0.5 CV comfort grinder with extension

- Length: 267 mm
- 1.015 kg

V.DG515F

£202.29



90° angle 0.5 CV comfort grinder

- Length: 175 mm
- 0.780 kg

V.DGA505F

£182.42

IMPACT WRENCHES \square 1/2" 18V WIRELESS

Impact wrench \square 1/2" high power 18V 5.0Ah

- Motor without carbon brushes
- Body and battery resistant to hydrocarbons and workshop solvents
- 3 speed for an approach without overtorque at speed 1 *
- Max torque 950 Nm, breakout torque 1 625 Nm
- Batteries use DEWALT technology, interchangeable with DEWALT batteries currently on the market
- Supplied in watertight and anti-shock tool box with 2 Li-ion 18V 5.0Ah batteries and one charger

 3.3 kg



3 speeds

Brushless motor

CL3.CH18SP2

£704.25

* Tightening of a second < 90Nm, necessary finish for torque wrench



Completely independent power

Impact wrench \square 1/2" compact 18V 2.0Ah

- Compact impact mechanism delivering 510 Nm
- Ideal for small spaces (wheel arches, triangular spaces, brakes, ball joints, etc.)
- Body and battery resistant to hydrocarbons and workshop solvents
- Batteries use DEWALT technology, interchangeable with DEWALT batteries currently on the market
- Supplied in watertight and anti-shock tool box with 2 Li-ion 18V 2.0Ah batteries and one charger

 2.4 kg

CL3.CC18SD2

£543.37

ACCESSORIES

HIGH RESISTANCE TOOL BOX

- Heavy-duty material
- Metal closures
- High level of protection for content IM65 (waterproofing)
- Lockable
- 4 practical and comfortable retractable handles
- Operating manual



INTENSIVE USE BATTERIES

- Large battery capacity: intensive use
- Dewalt® technology
- Long-lasting operation
- Visible charge level
- Moulded rubber material: Shock and abrasion resistant
- Resistance to oils and workshop solvents
- Universal multi-voltage charger: 1 single charger for 3 types of batteries

10.8 V - 2 Ah

18 V - 2 or 5 Ah



WIRELESS DUOS PACKS



Power and versatility

Duo pack "Power" 18 V wrench \square 1/2" + 13 mm drilling

- Pack delivered in rigid toolbox IP65 including:
 - 1 impact wrench 1/2" high power
 - 1 drill screwdriver/decapper 13 mm
 - 2 batteries 5.0 Ah 18 V
 - 1 multi-voltage charger (10.8 V - 18 V)
- 8.5 kg

CL3.CHP18SP2

£917.07



Compactness and lightness

Duo pack "Compact" 10.8 V impact wrench \square 1/2"

- Pack supplied in PROBAG textile satchel including:
 - 1 impact wrench 1/2" compact
 - 2 batteries 2.0 Ah 10.8 V
 - 1 multi-voltage charger 10.8 V - 18 V
- 1.3 kg

CL3.C10SD2

£405.39

ROLLING LIFTER 2 TONNES

NEW

CAPACITY 2 T

- Double hydraulic cylinder pistons
- Maximum lift 500 mm
- Minimum underslung height 75 mm
- Length 705 mm

INTEGRATED MECHANICAL LOCKING

- Built-in shaft post
- Mechanical locking at 290 mm
- Helps relieve hydraulic system in high position
- Prevents accidental lowering

ULTRA-SAFE LOWERING

- Speed control valve for lowering
- "Dead-man" function
- Mechanical pedal disengagement

FAST APPROACH PEDAL

- Fast lifting without load

NYLON WHEELS

- Avoid damage to the workshop floor
- Silent



2 YEARS

Efficient and innovative



- Compliant with CE standard EN1494-ASME-PASE
- 37.5 kg

DL.200SECUA

£391.40

AUTOMATIC OIL FILTER WRENCHES



Fits all diameters from 66 to 150 mm

- No adjustment
- Ratchet effect:
 - Rapid return
 - Adapted for the most compact of environments
- Optimised automatic tightening

VL model

- Capacity: filter elements from 66 to 105 mm

PL model

- Capacity: filter elements from 106 to 150 mm

U.48

£74.82

U.48PL

£82.30

ROLLER JACK 3 TONNES



2 YEARS

- Double piston for quick rising
- Rubber pad for underbody
- Tube equipped with foam protection
- Silent polyurethane wheels
- Overhead valve
- Maximum lift: 465 mm
- Compliant with CE standard EN1494-ASME-PASE
- Min. underbody clearance: 133 mm
- Dim. (L x D x H): 690 x 337 x 163 mm
- 30.5 kg

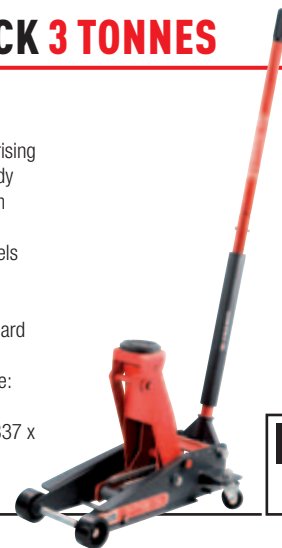

DL.32A

£180.25

BOTTLE JACKS – HEAVY DUTY SERIES

- Heat and surface treated
- Wide base, electronic ordering: better stability
- Cylinder with anti-corrosion treatment
- Carrying handle over 20 and 30 T

RANGE DESIGNED FOR HEAVY DUTY PROFESSIONAL USE

High resistance to angular effort (when being used on uneven surface).

POSSIBLE USE FOR SPECIAL JOBS

Allows for horizontal use as a pusher jack. Complies with machinery directive 2006/42/CE.

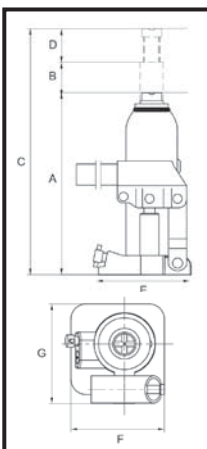

DETAILS OF SIZES

	A (mm)	B (mm)	C (mm)	D (mm)	E (mm)	F x G (mm)			Capacity
DL.2BTI	178	117	347	52	128	78 x 118	70 ml	2,4 kg	2 t
DL.5BTI	198	122	390	70	145	92 x 142	150 ml	3,7 kg	5 t
DL.8BTI	198	124	394	72	166	98 x 157	200 ml	4,6 kg	8 t
DDL.12BTI	238	150	468	80	190	119 x 173	370 ml	8,0 kg	12 t
DL.20BTI	270	160	430		223	144 x 193	620 ml	13,0 kg	20 t
DL.30BTI	280	165	445		232	150 x 202	830 ml	18,4 kg	30 t

DL.2BTI

£51.98

DL.5BTI

£79.57

DL.8BTI

£105.03

DL.12BTI

£132.61

DL.20BTI

£185.66

DL.30BTI

£238.70

BATTERY CHARGERS

NEW

Available Spring 2018



UNIVERSAL

- Designed to charge all types of lead batteries: VLRA, AGM, GEL, liquid
- Compatible with vehicles and Start & Stop batteries

SAFETY

- Reverse polarity protection
- Protection against incorrect voltage
- No-spark technology
- Battery maintenance mode
- Voltage output limited to 14.7V

ADVANCED FEATURES

- Intelligent charging programme in 8 stages
- "Showroom" charging mode (only BC1215)
- Charge controlled by microprocessor

CHARGING ACCESSORIES

- Insulated pliers and wire rings (with fuse) (only BC126)

100% automatic, fast and safe charging!

Battery charger 12 V

- Maximum output current: 6 A

BC126

£203.94

BC1215

£245.14

Battery charger 12 V

- Maximum output current: 15 A

BC2410

£256.47

Battery charger 24 V

- Maximum output current: 10 A

BOOSTER 12 V

NEW

Performance, heavy-duty, safety



- Safety switch and polarity inversion alarm
- AGM internal sealed battery 12 V
- Capacity: 22 Ah
- Actual current to pliers: 780 A
- Peak current: 3500 A
- Cables: copper with double insulation
- Section cables: 25 mm²
- Length of cables: 155 cm
- 650 A pliers with bronze insert
- Charge indicator
- Charge: 12 v 2 A with charge maintenance mode
- Delayed-action fuse 300 A protection

B12.SECU

£3,790.40

BOOSTERS 12-24 V

NEW

Heavy-duty, safety

- Applications: VL, PL, TP, bus, agricultural, military
- Safety switch and polarity inversion alarm
- 2 AGM internal sealed batteries 12 V
- Capacity: 2 x 20 Ah (B124.1A) - 2 x 50 Ah (B124.HD)
- Actual current to pliers: 1000 A
- Peak current: 3700 A (B124.1A) - 7750 A (B124.HD)
- Cables: copper with double insulation
- Section cables: 25 mm² (B124.1A) - 70 mm² (B124.HD)
- Length of cables: 155 cm (B124.1A) - 210 cm (B124.HD)
- Bent-nose pliers 850 A - 100% bronze
- Charge indicator
- Charge: 12V 4A (B124.1A) - 12V 7A (B124.HD) with charge maintenance mode
- Delayed-action fuse protection 300 A (B124.1A) - 500 A (B124.HD)



Start up all vehicles 12 and 24 V

B124.1A

£1,307.07



Optional cables sold for: MAN, CATERPILLAR, OTAN and vehicle type

B124.HD

£3,481.84

BOOSTER INFINIMAX

NEW

New interface showing state of charge of booster:

- Solid green: Booster ready to start the vehicle
- Flashing green: Booster ready to start the vehicle (might not have enough charge to start the vehicle)
- Flashing yellow: Booster is charging
- Flashing red with buzzer: reversed polarity, short circuit, overvoltage (connected to the battery > 15V)



12 volts

For all 12 V vehicles, cars, motorcycle, agricultural vehicles, marine vehicles, etc.

**+40 °C
-10 °C**

Resistant to extreme conditions

The only market booster with 100% electronic protection

- 12 V booster with energy storage: automatic recharging
- Active electronic protection against short circuit, polarity reversal, poor voltage (e.g. 24V battery), sparks, etc.
- Fits all engines equipped with a 12 V battery
- 100% electronic protection: superior durability to boosters with mechanical protection

UCB12A

£1,038.24

WORKSHOP PRESSES

NEW

HYDRAULIC JACK 15, 20, 30 OR 50 T

- Manual lever + pedal (manual lever only for the 15 T bench press W.415WBA)
- Laterally adjustable cylinder
- TABLE CAN BE ADJUSTED IN HEIGHT**
- Integrated winch for press 50 T W.450
- GROUND ANCHORING POSSIBLE**
- INTEGRATED PRESSURE GAUGE**
- Dual display N.m. and psi
- Pressure gauge at eye-height

ACCESSORIES INCLUDED

- Supplied with a reversible V pair and a complete set of pushers on stand*.

* FULL SET OF PUSHERS INCLUDED

Ø mm	L mm	t max.
12	60	3
16	60	8
18	85	12
20	85	14
22	85	16
25	110	18
30	110	20

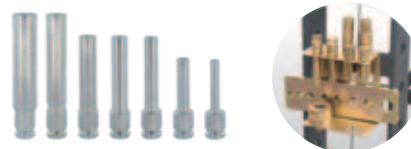

GARANTIE
GUARANTEE

Compact and powerful

2+1 YEARS



15 T bench press

- CYLINDER STROKE: 160 mm
- LATERAL STROKE: 169 mm
- Dim. overall (L x D x H): 700 x 540 x 965 mm

W.415WBA

£896.46

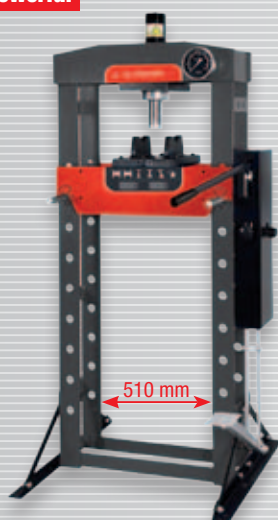

20 T press

- CYLINDER STROKE: 185 mm
- LATERAL STROKE: 179 mm
- Dim. overall (L x D x H): 730 x 560 x 1626 mm

W.420

£1,270.96

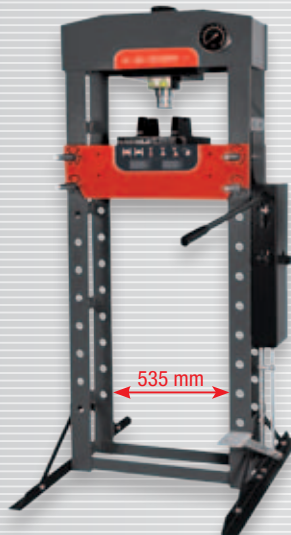

30 T press

- CYLINDER STROKE: 150 mm
- LATERAL STROKE: 200 mm
- Dim. overall (L x D x H): 795 x 700 x 1830 mm

W.430

£1,482.08

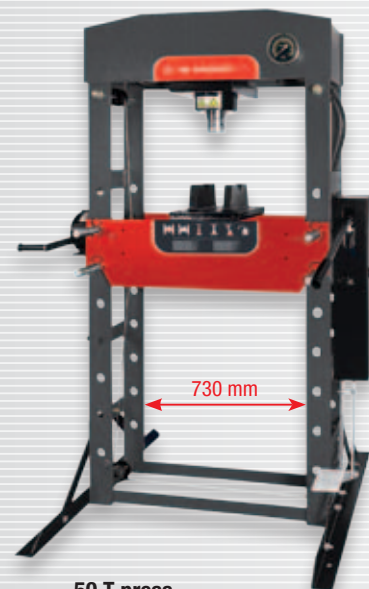

50 T press

- CYLINDER STROKE: 200 mm
- LATERAL STROKE: 245 mm
- Dim. overall (L x D x H): 1030 x 800 x 1877 mm

W.450

£2,545.10

PROTECTION FOR PRESSES

NEW

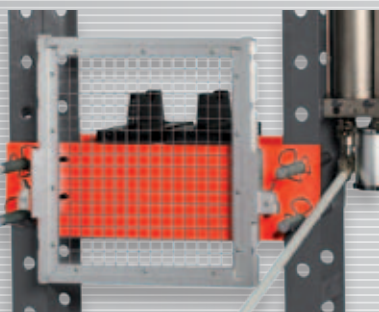

Easy and secure

- For 20T, 30T, 50T presses
- Protective guard mounted on rails, adjustable in height
- Screw fastening system

FOR PRESSES:

W.PROTECT20

W.420

£115.64

W.PROTECT30

W.430

£126.25

W.PROTECT50

W.450

£136.86



T-SHIRT 2 TONE NEW

- High quality T-shirt
- Embroidered square logo
- Two-coloured: red and black

MATERIAL

- 100% cotton
- 180 grammes



VP.TSHIRT
£19.10

POLO 2 TONE NEW

- Neck opening with 3 buttons
- Embroidered square logo
- Two-coloured: red and black

MATERIAL

- 100% cotton
- 180 grammes



VP.POLOBLK
£26.52

SOFTSHELL 2 TONE NEW

- Water repellent up to 8 000 mm
- Breathable 1 000 MVP
- 2 low pockets with zip fastening
- Lateral adjustment with elasticated cord
- Adjustable cuffs
- Embroidered square logo
- Two-coloured: red and black

MATERIAL

- 94 % polyester - 6 % elastane



VP.SOFTA
£73.20

BODY WARMER

- Lined detachable hood
- Drawstring
- Inside pocket
- 2 low pockets and 1 zip chest pocket

MATERIAL

- Taslan nylon ripstop with AC coating, 220T



VP.BODYW
£55.66

SIZES	S	M	L	XL	2XL
T-SHIRT	VP.TSHIRT-S	VP.TSHIRT-M	VP.TSHIRT-L	VP.TSHIRT-XL	VP.TSHIRT-2XL
POLO	VP.POLOBLK-S	VP.POLOBLK-M	VP.POLOBLK-L	VP.POLOBLK-XL	VP.POLOBLK2XL
SOFTSHELL	VP.SOFTA-S	VP.SOFTA-M	VP.SOFTA-L	VP.SOFTA-XL	VP.SOFTA-2XL
BODY WARMER	VP.BODYW-S	VP.BODYW-M	VP.BODYW-L	VP.BODYW-XL	VP.BODYW-2XL

MULTI-POCKET TROUSERS

- Pockets for holding tools on belt
- Velcro pockets for knee pads
- Ruler pocket and cargo pocket
- Reinforced rear pocket, flap pocket with snap fastening on left
- Suitable for a hammer

MATERIAL

- 65 % polyester, 35 % cotton, 260 gsm



VP.PANTA
£46.32

DOUBLE CLOSURE-BOILERSUIT

- Boilersuit with protective double zip closure
- 1 chest pocket and 1 pocket for mobile phone and ruler
- 2 double lower pockets
- Waist completely elasticated at the back

MATERIAL

- 100% cotton



VP.COMB2
£59.66

SIZES	S	M	L	XL	2XL	3XL	4XL
TROUSERS	VP.PANTA-S	VP.PANTA-M	VP.PANTA-L	VP.PANTA-XL	VP.PANTA-XXL	VP.PANTA-XXXL	VP.PANTA-XXXX
COMBINAISON	VP.COMB2-S	VP.COMB2-M	VP.COMB2-L	VP.COMB2-XL	VP.COMB2-2XL		

COMPLEMENTARY RANGE OF SAFETY SHOES

You can also find the complete range of FACOM by DICKIES safety shoes®.

Check with your distributor.





The textile storage range



HIGH RESISTANCE FABRIC

- Very tough fabric 1200 deniers



DESIGNED TO LAST

- Rigid and watertight compartment for tool boxes BS.T and rucksack BS.L30
- Wide rubber feet on the satchel BS.SMB



EASY TO TRANSPORT

- Carry strap is adjustable and is reinforced in foam
- Grab handles



PRACTICAL TIDYING SOLUTION

- Numerous pockets, hooks, partitions, straps, dedicated spaces



QUICK AND EASY ACCESS

- 100% opening for easy access to tools



LARGE VOLUME TOOL BAG

Textile bag, PVC coated, 50 cm

- Useful volume: 34 L
- Can accommodate tools of up to 50 cm long: saws, levels, large wrenches
- Splash-proof, easy to clean and maintain
- Useful volume: 12.25 L
- Dimensions (L x W x H): 540 x 160 x 220 mm

2.237 kg

MAXIMUM LOAD: 11 KG

Waterproof, lightweight and resistant Probag



BS.LMBC

£88.84

* Delivery does not include items or tools.

TEXTILE TOOL BOXES

"Mini" PROBAG 14"

- Useful volume: 34 L
- Vertical practical tidying solution: immediate access to tools
- Dimensions (L x W x H): 390 x 250 x 340 mm

2.237 kg

MAXIMUM LOAD: 11 KG



BS.T14

£71.74

PROBAG 20"

- Useful volume: 47 L
- Vertical practical tidying solution: immediate access to tools
- Dimensions (L x W x H) : 600 x 310 x 370 mm

3.240 kg

MAXIMUM LOAD: 15 KG



BS.T20

£90.42

* Delivery does not include items or tools.

TEXTILE TOOL BOXES ON WHEELS



- Contents of the bag are widely accessible with its many indoor and outdoor fittings
- 3 carrying solutions: wheels and telescopic handle, aluminium handle with leather lining, strap with support cushion at the level of the shoulder
- Can also accommodate computer bag BS.PC15
- Useful volume: 33 L
- Dimensions (L x W x H) : 550 x 360 x 440 mm

5.400 kg

MAXIMUM LOAD: 18 KG



BS.R20

£172.59

* Delivery does not include items or tools.

MODULAR AND COMPACT BACKPACK



COMPACT

- Specifically designed for safety ladders and hoop ladders



PRACTICAL

- Ring for hanging tools



ORGANISED STORAGE

- Multiple storage and hanging solutions



Resistant and practical

- Resistant and waterproof nylon fabric
- Lockable sliding closures
- Clever inner organisational structure: velcro removable pouches, hook rings and removable "organiser" bag
- Padded and adjustable straps
- Useful volume: 20 L
- Dimensions (L x D x H): 300 x 180 x 480 mm

2.7 kg

MAXIMUM LOAD: 10 KG



BS.MCB

£158.07

* Delivery does not include items or tools.

TEXTILE BACKPACK



Extremely comfortable

- Back with high density foam
- Foamed and adjustable braces, sternum belts and ventral belts
- Numerous pockets and hooks for organising tools
- Foam sleeve for computer (15")
- "Organiser" bag, removable and versatile
- Capacity: 30 litres
- Dimensions (L x D x H): 355 x 225 x 460 mm

3.150 kg

MAXIMUM LOAD: 12 KG



BS.L30

£149.42

* Delivery does not include items or tools.

TEXTILE BAG 2-IN-1

Versatile bag for your tools and your PC



2-in-1 tool and PC bag

- Numerous internal storage options for tools
- 1 foam sleeve for a laptop (15" max.)
- 100% access when the bag is completely open
- Dimensions (L x D x H): 460 x 150 x 350 mm

1.9 kg

MAXIMUM LOAD: 7 KG

BS.TLB

£91.51

* Delivery does not include items or tools.

Backpack with wheels and telescopic handle

EXTREMELY COMFORTABLE:

- Telescopic handle
- Solid castors
- Foam padded, adjustable straps
- Back with high density foam

QUALITY:

- 1200 denier
- Dimensions L 335 x D 158 x H 554 mm

MAXIMUM LOAD: 25 KG



Storage spaces with zippers on the front and pockets on the sides

Ideal for mobile maintenance. Can be used as a trolley or backpack

BS.RB

£157.10

* Delivery does not include items or tools.

TOOL MAT AND SAFETY TRIANGLE



Tool mat

- Dimensions: folded 40 x 40 x 40 cm or unfolded 113 x 110 cm
- 2.5 kg

Unfold or fold your tool mat instantly in just 3 seconds!



SAFETY

- The tools are in a clearly defined space, thus avoiding any risk of loss or accident.
- Avoid the spread of FOD and waste after the job. Elastic loops on the edge of the mat to store tools.

CLEAN OPERATION

- Easy option for leaving your work area clean after the job!
- Can carry up to 5 kg of waste and tools.

COMFORT

- Surface of mat in welded PVC: protection against water, oil, different liquids.
- Easy to maintain.



OFFER

Safety triangle

- Detachable with reflective strips
- Space for an A4 sheet + a hook to add security signs if needed
- Dimensions: 36.2 x 37 x 29.41 cm
- 0.6 kg



Take a look at the video of the tool mat by scanning this code

Tool mat and safety triangle

BS.EXTMKIT

£118.08

FACOM TOOL BOXES "TOOL BOX"



LATCH TO OPEN WITH ONE HAND, self-closing valve
CAN BE LOCKED with padlocks (not provided)
+2 TIDY COMPARTMENTS over the cover,
 accessible closed box
REMOVABLE SHUTTLE TRAY
TOOL BOXES CAN BE STACKED 3 volumes available



Automatic closure

16" small model

- Dim. (L x D x H): 394 x 220 x 162 mm
- 1.120 kg
- MAXIMUM LOAD: 5.5 KG**

BP.C16N

£20.73



19" medium model

- Dim. (L x D x H): 486 x 266 x 236 mm
- 2.000 kg
- MAXIMUM LOAD: 12 KG**

BP.C19N

£30.49



24" large model

- Dim. (L x D x H): 595 x 281 x 260 mm
- 2.750 kg
- MAXIMUM LOAD: 15 KG**

BP.C24N

£44.24

* Delivery does not include items or tools.

5 CASE METALLIC TOOL BOXES



Classic model

- Dim. (L x D x H): 470 x 220 x 215 mm
- 5.000 kg
- MAXIMUM LOAD: 25 KG**

BT.11A

£ 102.57

Large volume model

- Dim. (L x D x H): 560 x 220 x 215 mm
- 6.390 kg
- MAXIMUM LOAD: 30 KG**

BT.13A

£115.13

* Delivery does not include items or tools.

FACOM TOOL BOXES "PRO BOX"

ROBUST, reinforced polypropylene compartment, metal wire hinges, padlockable metal locks (lock not included)

FLEXIBLE bumpers on angles
CAN BE LOCKED
 with padlocks (not provided)

REMOVABLE SHUTTLE TRAY



20" model

- Dimensions (L x W x H): 502 x 268 x 273 mm
- 2.340 kg
- MAXIMUM LOAD: 10 KG**

BP.P20A

£48.21

26" model

- Dimensions (L x W x H): 650 x 268 x 273 mm
- 2.965 kg
- MAXIMUM LOAD: 13 KG**

BP.P26A

£56.30

* Delivery does not include items or tools.

ORGANISERS

Essential for
workshop consumable items

8-box organiser

- Transparent and extra-strong cover locking internal boxes
- 8 removable and dividable compartments (up to 10 boxes)
- Dim. (L x D x H): 422 x 335 x 106 mm
- 1.743 kg



BP.Z8

£48.66

* Delivery does not include items or tools.

3-in-1

XL organiser

- 3 storage spaces:
 - Small parts side: 9 removable partitions,
 - central compartment: hand tools
 - machinery side (power tools): 6 removable partitions
- Capacity: organiser 2 x 6 L + central base 4.7 L
- Dim. (L x D x H): 426 x 316 x 234 mm
- 2.670 kg
- MAXIMUM LOAD: 15 KG**



BP.Z46A

£81.07

* Delivery does not include items or tools.

6-DRAWER ROLLER SERVICE CART

1 HANDLE ON EACH SIDE

- Allows the service cart to be lifted for the passage of obstacles



REINFORCED WORK SURFACE

- Resistant to a static load of 700 kg, resistant to impact and hydrocarbons

INTEGRATED LIP

- Prevents tools from falling

SECURE

- New side lock to avoid the risk of breakage. Central locking by key lock, supplied with 2 keys, 1 of which is articulated

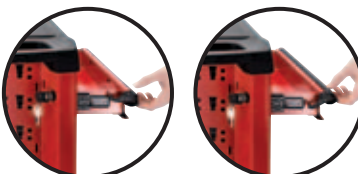

SECURE LOCKED DRAWERS

- No risk of opening when being moved. The tilting front unlocks the drawers automatically
- Drawers can be fitted with any thermoformed or foam modules in the Facom Modular system

EASY TO HANDLE

- 4 wheels Ø 125 mm, 2 swivel, one of which has a brake

ACCESSORISABLE

- Sides of the service cart are perforated to accommodate accessories in the JETXL range.
- Includes stand for bottles (can be positioned on the right or left)



Characteristics:

- 6 drawers:
 - 3 drawers height 60 mm
 - 2 drawers height 130 mm
 - 1 drawer height: 200 mm
 - max. load per drawer: 20 / 25 / 30 kg
- Dim. overall including wheels and work surface (L x D x H): 748 x 515 x 970 mm
- Useful dim. of drawers (L x D x H): 569 x 421 x 60 / 130 / 200 mm
- Comes in two colours: red 3020 or grey 9006
- 53.50 kg

ROLL.6M3
 ROLL.6GM3
£582.43

ROLLER WORKSHOP CART



Very resistant with wide trays for maximum storage!

- Metal handle for better manoeuvrability
- 3 metal trays with protection
- 2 different positions for the middle tray
- Very easy to handle: • 4 wheels Ø 100 mm, 2 swivel, 2 fixed, 1 of which with brake
- Maximum static load: 200 kg
- Dim. (with handle) (L x D x H): 859 x 470 x 927 mm
- Useful dimensions of shelving: L 745 x D 455 mm
- Supplied in a kit - quick and easy to assemble
- 20.0 kg

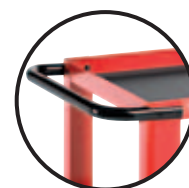

ROLL.UC3S
£200.51

SERVICE CART *CHRONO*

NEW

2 RECESSED HANDLES

- With soft lining, 1 for moving, 1 to allow the service cart to be lifted for the passage of obstacles



SAFETY

- Lock positioned on the side
- Central locking with key lock (supplied with 2 keys, 1 of which is articulated)

ACCESSORIES

- Stand for bottles + stand for roll of paper included (can be positioned on the right or left)
- Sides of the service cart are perforated to accommodate accessories in the JETXL range.



* Delivery does not include paper.

WORK PLAN

- Large work surface 560 x 460 mm in polypropylene reinforced with glass fibre
- Resistant to impact and hydrocarbons at a static load of 850 kg

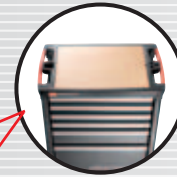

INTEGRATED LIP

- Prevents tools from falling
- Allows the addition of a wooden tray CHRONO.A14M3

DRAWERS

- Equipped with ball bearing sliders, with return spring "soft close" = gentle and secure closure
- Handle in anodised aluminium = ideal comfort and grip
- 3 ways to open the drawers



MANEUVERABILITY

- 4 wheels Ø 125 mm, 2 swivel (1 of which with brake) and 2 fixed
- Service cart delivered with mounted wheels

TWO COLOURS

- Comes in red 3020 or grey 9004



6 drawer service cart

- 4 drawer height 60 mm = 12 modules
- 1 drawer height 130 mm = 3 modules
- 1 drawer height 270 mm (can also accommodate modules)
- Maximum load per drawer: 20 / 25 / 35 kg
- Dim. overall including wheels and work surface (L x D x H): 779 x 518 x 971 mm
- Useful dim. of drawers (L x D x H): 569 x 421 x 60 / 130 / 270 mm

• 62,50 kg

□ CHRONO.6M3A
□ CHRONO.6GM3A

£884.76



7 drawer service cart

- 5 drawer height 60 mm = 15 modules
- 1 drawer height 130 mm = 3 modules
- 1 drawer height 200 mm (can also accommodate modules)
- Maximum load per drawer: 20 / 25 / 30 kg
- Dim. overall including wheels and work surface (L x D x H): 779 x 518 x 971 mm
- Useful dim. of drawers (L x D x H): 569 x 421 x 60 / 130 / 200 mm

• 64.50 kg

□ CHRONO.7M3A
□ CHRONO.7GM3A

£922.44



8 drawer service cart

- 6 drawer height 60 mm = 18 modules
- 2 drawer height 130 mm = 6 modules
- Load per drawer: 20/25 kg
- Dim. overall including wheels and work surface (L x D x H): 779 x 518 x 971 mm
- Useful dim. of drawers (L x D x H): 569 x 421 x 60 / 130 mm

• 66.5 kg

□ CHRONO.8M3A
□ CHRONO.8GM3A

£961.64

NEW

WOODEN TOP FOR CHRONO ROLL CABINETS



- Placement in the hollow of the work surface of the service cart CHRONO.M3A
- In beech plywood tinted with linseed oil, thickness: 15 mm
- Dim. (L x D): 560 x 460 mm
- 2.5 kg

CHRONO.A14M3

£110.33

ROLLER CABINETS

SERVICE CARTS



Find the right size for you!



2 RETRACTABLE EDGES

- Under a heavy load, the edges of the work surface retract and disappear into the work surface



2 ELEVATED EDGES

- At the front and at the rear to avoid objects falling



WORK PLAN

- With recessed handle, room for 16 screwdrivers, fixing of a vice, tube accessories



HIGH RESISTANCE WHEELS

- Reduced starting tractive power
- Long service life
- High resistance to heavy loads



DRAWERS

- 100% opening = easy access



CENTRAL LOCKING

- Lock recessed in a specific place, with articulated key



SOFT BUMPERS

- Impact shock absorber on the 4 corners on the drawers, protecting the aluminium hook



COLOURS

- All of our JET+ SERVICE CARTS come in dark grey
- Special colours on request: mini quantity, 6 service carts, price and delivery time on demand



5 MODULES PER DRAWER



5 modules per drawer

1 2 3 4 5



Unrivalled storage capacity

- Dim. overall including wheels and work surface (L x D x H): 1 154 x 546 x 1 000 mm
- Static resistance: 1 100 kg



8 DRAWERS

- 6 drawer height 60 mm = 30 modules
- 2 drawer height 130 mm = 10 modules
- Total permitted load in the drawers: 290 kg
- ▲ 110.0 kg

□ JET.8GM5
■ JET.8M5
£2,095.41

7 DRAWERS

- 5 drawer height 60 mm = 25 modules
- 1 drawer height 130 mm = 5 modules
- 1 drawer height 200 mm
- Total permitted load in the drawers: 265 kg
- ▲ 107.0 kg

□ JET.7GM5
■ JET.7M5
£2,037.34

6 DRAWERS

- 3 drawer height 60 mm = 15 modules
- 2 drawer height 130 mm = 10 modules
- 1 drawer height 200 mm
- Total permitted load in the drawers: 235 kg
- ▲ 104.5 kg

□ JET.6GM5
■ JET.6M5
£1,972.83

ACCESSOIRES

NEW



Overall cleanliness

- Honeycombed magnetic tablet + paper stand*
- Waste bins

JET.A5GXL

£292.56



Folding shelf

- Robust and folding tray to extend the work surface
- Design load: 20 kg
- Compatible with JET+, CHRO-NO+ service carts

JET.A16

£105.61



Support clamp

- Work surface in 40 mm thick wood upon which the vice can be installed (not included)
- Compatible with JET+ service carts

JET.A17

£136.90

* Delivery does not include paper.

4 MODULES PER DRAWER



4 modules per drawer



The best compromise

964 mm



- Dim. overall including wheels and work surface (L x D x H): 964 x 546 x 971 mm
- Static resistance: 1 000 kg

3 MODULES PER DRAWER



3 modules per drawer



Concentrated performance

774 mm



- Dim. overall including wheels and work surface (L x D x H): 774 x 546 x 971 mm
- Static resistance: 900 kg

8 DRAWERS

- 6 drawer height 60 mm = 24 modules
- 2 drawer height 130 mm = 8 modules
- Total permitted load in the drawers: 210 kg

□ JET.8GM4
■ JET.8M4

£1,501.88

8 DRAWERS

- 6 drawer height 60 mm = 18 modules
- 2 drawer height 130 mm = 6 modules
- Total permitted load in the drawers: 170 kg

□ JET.8GM3
■ JET.8M3

£1,282.53

7 DRAWERS

- 5 drawer height 60 mm = 20 modules
- 1 drawer height 130 mm = 4 modules
- 1 drawer height 200 mm
- Total permitted load in the drawers: 195 kg

□ JET.7GM4
■ JET.7M4

£1,418.02

7 DRAWERS

- 5 drawer height 60 mm = 15 modules
- 1 drawer height 130 mm = 3 modules
- 1 drawer height 200 mm
- Total permitted load in the drawers: 155 kg

□ JET.7GM3
■ JET.7M3

£1,184.47

6 DRAWERS

- 4 drawer height 60 mm = 16 modules
- 1 drawer height 130 mm = 4 modules
- 1 drawer height 270 mm
- Total permitted load in the drawers: 175 kg

□ JET.6GM4
■ JET.6M4

£1,327.69

6 DRAWERS

- 4 drawer height 60 mm = 12 modules
- 1 drawer height 130 mm = 3 modules
- 1 drawer height 270 mm
- Total permitted load in the drawers: 140 kg

□ JET.6GM3
■ JET.6M3

£1,088.99

5 DRAWERS

- 2 drawer height 60 mm = 6 modules
- 2 drawer height 130 mm = 6 modules
- 1 drawer height 270 mm
- Total permitted load in the drawers: 125 kg

□ JET.5GM3
■ JET.5M3

£1,030.94

Service cart delivered without modules.

HIGH RESISTANCE CARTS *CHRONO*

NEW

WORK PLAN

- Large work surface 760 x 540 mm in 30 mm thick beech plywood (round corners)
- Resistant to a static load of 1000 kg, ideal for installing a vice

SAFETY

- Lock positioned on the side
- Central locking with key lock (supplied with 2 keys, 1 of which is articulated)

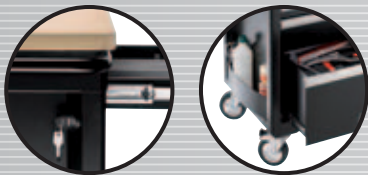

ACCESSORIES

- Stand for bottles + stand for roll of paper included (can be positioned on the right or left)
- Sides of the service cart are perforated to accommodate accessories in the JETXL range.



2-in-1:

Heavy loads and safety

DRAWERS

- 3 modules per drawer
- Equipped with ball bearing sliders, with return spring "soft close" = gentle and secure closure
- Handle in anodised aluminium = ideal comfort and grip

SAFETY LOCK SYSTEM

- Interlock system preventing the simultaneous opening of several drawers = eliminates risk of tipping over the service cart



MANEUVERABILITY

- Wide handle in metal paint
- 4 wheels JET+ range, Ø 125 mm: 2 swivel (1 of which with brake) and 2 fixed
- Resistance to chips and the most common hydrocarbon products
- Service cart delivered with mounted wheels

6 drawer service cart

- 4 drawer height 60 mm = 12 modules
- 1 drawer height 130 mm = 3 modules
- 1 drawer height 270 mm
- Maximum load per drawer: 50 kg
- Dim. overall including wheels and work surface (L x D x H): 848 x 540 x 997 mm
- Useful dim. of drawers (L x D x H): 569 x 421 x 60 / 130 / 270 mm
- ▲ 77.0 kg



CHRONO.6GM3HD

£1,292.69

8 drawer service cart

- 6 drawer height 60 mm = 18 modules
- 2 drawer height 130 mm = 6 modules
- Maximum load per drawer: 50 kg
- Dim. overall including wheels and work surface (L x D x H): 848 x 540 x 997 mm
- Useful dim. of drawers (L x D x H): 569 x 421 x 60 / 130 mm
- ▲ 80.5 kg



CHRONO.8GM3HD

£1,431.71

SERVICE CART SAFETY RANGE *JET+*



INTERLOCKING OF SAFETY LOCK SYSTEM DRAWERS

- Prevents the simultaneous opening of several drawers
- No risk of tipping

SELECTIVE OPENING OF DRAWERS CENTRAL DRAWER LOCKING

- 3 modules per drawer
- Dim. overall (L x D x H): 774 x D 546 x H 971 mm (including wheels and work surface)
- 4 wheels Ø 125 mm (2 swivel, 1 of which with brake, 2 fixed)

The triple safety service cart

6 drawer service cart

- 6 drawers = 15 modules in the drawers of 60 and 130 mm
- Total permitted load in the drawers: 140 kg
- ▲ 75.5 kg

JET.6GM3S

£1,197.88

8 drawer service cart

- 8 drawers = 24 modules in the drawers of 60 and 130 mm
- Total permitted load in the drawers: 170 kg
- ▲ 79.5 kg

JET.8GM3S

£1,346.66

CART WITH PHONE OPERABLE LOCK **JET+**

NEW



E-ACCESS CARDS

- Encoding/cancellation of cards via encoding and reset cards
- Opening and closing of the drawers via user cards



APPLICATION ANDROID SMARTPHONE[®] VIA NFC

- For the personalised management of certain parameters (traceability of users, management of timing of automatic closure and battery status) ** free*



SUPPLIED WITH:

- 1 encoding card
- 1 reset card
- 2 user cards
- 1 emergency key
- 4 batteries 1.5 V AAA

E-ACCESS service cart: welcome to the 21st century!

FAST AND SECURE ACCESS

- Electronic opening system, using Mifare[®] badge protocol
- Quick opening: no mechanism to activate, simply present the card in front of the antenna.
- Centralised locking of all drawers
- Autonomous system: works with 4 standard 1.5V AAA batteries (supplied)
- Supplied with 1 encoding card and 1 reset card: possible to grant or revoke access in seconds (up to 100 users)



SAFETY

- Alert sound and warning light when the battery level becomes low
- Emergency key always allows you to open the service card if the battery is flat



ROBUST WORK SURFACE

- In anodised aluminium with recessed handles, room for 16 screwdrivers
- Resistant to a static load of 900 kg
- Raised edges at the front and at the rear to avoid tools falling

CENTRAL LOCKING DRAWERS

- Equipped with ball bearing sliders, total extension



SOFT BUMPERS

- Impact shock absorber on the 4 corners on the drawers, protecting the aluminium hook

HIGH RESISTANCE WHEELS

- 4 wheels Ø 125 mm, 2 swivel (1 of which with brake) and 2 fixed
- Service cart delivered with mounted wheels

E-access 7 drawer service cart

- 5 drawers height 60 mm
- 1 drawer height 130 mm
- 1 drawer height 200 mm
- Maximum load per drawer: 20 / 25 / 35 kg
- Dim. overall including wheels and work surface (L x D x H): 774 x 546 x 971 mm.
- Useful dim. of drawers (L x D x H): 569 x 421 x 60 / 130 / 200 mm
- 78.0 kg



JET.7GM3EACC

£1,767.08

E-access 8 drawer service cart

- 6 drawers height 60 mm
- 2 drawers height 130 mm
- Maximum load per drawer: 20 / 25 kg
- Dim. overall including wheels and work surface (L x D x H): 774 x 546 x 971 mm.
- Useful dim. of drawers (L x D x H): 569 x 421 x 60 / 130 / 270 mm
- 80.0 kg



JET.8GM3EACC

£1,799.94

CHESTS / ROLLER CHESTS

Our chests and roller chests are produced in Feuquières-en-Vimeu (80)

ROLLER CHEST ROLL

NEW REINFORCED WORK SURFACE

- Resistant to a static load of 700 kg
- Resistant to impact and hydrocarbons
- Raised edges: prevents tools from falling

1 RECESSED HANDLE ON EACH SIDE

ACCESSORISABLE

- Sides of the chests are perforated to accommodate accessories in the JETXL range.
- Includes stand for bottles

EASY TO HANDLE

- 4 wheels Ø 125 mm, 2 swivel, (one of which has a brake) and 2 fixed

FOLDING HANDLE IN HIGH QUALITY METAL

SECURE LOCKED DRAWERS

- No risk of opening when being moved.

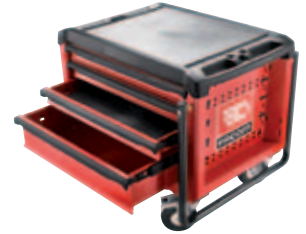

SECURE

- New side lock to avoid the risk of breakage (supplied with 2 keys, 1 of which is articulated)

Roller chest 4 drawers

- 3 drawers height 60 mm
- 1 drawer height 130 mm
- Maximum load per drawer: 20/25 kg
- Dim. overall including wheels and work surface (L x D x H): 748 x 585 x 650 mm
- Useful dim. of drawers (L x D x H): 569 x 421 x 60 / 130 mm
- 39.0 kg

ROLL.CR4M3

£529.39

CHESTS CHRONO

NEW

WORK PLAN

- Large work surface in polypropylene
- Resistant to impact and hydrocarbons at a static load of 700 kg

INTEGRATED LIP

- Prevents tools from falling when moving

FIXING

- Supplied with ROLL3-05 fixing kit = quick and secure assembly on CHRONO.M3A service cart

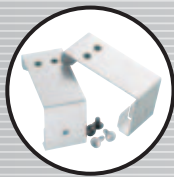

2 RECESSED HANDLES

- With soft covering



TWO COLOURS

- Comes in red 3020 and black 9004

SAFETY

- Lock positioned on the side
- Central locking with key lock (supplied with 2 keys, 1 of which is articulated)

ACCESSORIES

- Includes stand for bottles (can be positioned on the right or left)

DRAWERS

- Equipped with ball bearing sliders, with return spring "soft close" = gentle and secure closure

4-drawer toolbox

- 3 drawer height 60 mm = 9 modules
- 1 drawer height 130 mm = 3 modules
- Maximum load per drawer: 20/25 kg
- Use alone or in addition to a CHRONO.M3A service cart (see introduction, page 51)
- Dim. overall including work surface (L x D x H): 779 x 518 x 466 mm
- Useful dim. of drawers (L x D x H): 569 x 421 x 60 / 130 mm
- 35,0 kg

□ CHRONO.C4M3A
□ CHRONO.C4GM3A

£658.32

MOBILE WORKBENCHES **JET+**

Our chests and roller chests are produced in Feuquières-en-Vimeu (80)



WORK SURFACE

- Formed aluminium (2 mm thickness) reinforced with a 15 mm wooden board.
- Option to add a wood tray ref. JET. A14M5.

STORAGE VOLUME

- 6 or 7 drawers for capacity of 15 to 18 modules distributed over drawers of 60 and 130 mm
- Total permitted load in the drawers: 140 kg and 155 kg.
- 1 large volume compartment, with key lock.

EXCEPTIONAL MANOEUVRABILITY

- 4 wheels of 160 mm (very high performance): 2 swivel (2 of which with brake) and 2 fixed.

Characteristics:

- 3 modules per drawer
- Static resistance: 1,100 kg
- Useful storage volume: 155 L
- Dim. overall including wheels and work surface (L x D x H): 1154 x 546 x 1000 mm



6 drawers
▲ 100.0 kg

□ JET.T6GM3
■ JET.T6M3
£1,719.13

7 drawers
▲ 103.0 kg

□ JET.T7GM3
■ JET.T7M3
£1,842.02

ROLLER CHESTS **JET+**



3 modules per drawer

1 | 2 | 3



Ideal for mobile maintenance

- 4 drawers = 12 modules distributed over drawers of 60 and 130 mm
- Retractable handle for travel
- High performance wheels (diam. 125 wheels; 2 swivel, (one of which has a brake) and 2 fixed)
- Total permitted load in the drawers: 85 kg
- Dim. overall including wheels and work surface (L x D x H): 774 x 546 x 621 mm

▲ 48.5 kg



□ JET.CR4GM3
■ JET.CR4M3
£940.62

SERVICE CART CHEST



Supplied without tools.

- Transportable in a vehicle
- 125mm wheels for transporting chest over long distances without fatigue
- 2 drawers, height: L 100 x D 360 x H 300 mm
- Each drawer has a mobile tray, L 360 x D 148 x H 40 mm, for the storage of small tools
- 2 compartments: L 440 x D 140 x H 60 mm
- The inside of the lid of the service cart allows the storage of documents or flat objects (hacksaw, level, etc.)
- Large volume compartment, L 668 x W 443 x H 248 mm
- Locking with padlock possible (not supplied)
- Underseal on rounded chest provides protection for Achilles heel

▲ 34.9 kg

2092B

£720.35

WORK BENCHES

2 METRES ROLLER WORK BENCHES

Our work benches are produced in Feuquières-en-Vimeu (80)

2 tray finishes:

galvanised or wood



- 6 drawer storage unit:
- 3 drawers height 60 mm - 2 drawers height 130 mm - 1 drawer height: 200 mm
- Maximum load per drawer: 20/25/30 kg
- Automatic locking system for drawers
- Lock on the side, central locking by key lock, supplied with 2 keys, 1 of which is articulated

Wood tray version

- Static resistance load: 1 000 kg
- Dim. overall (L x D x H): 2 000 x 700 x 852 mm
- 89.0 kg



2000.ROLL6M3W

£1,059.84

Galvanised tray version

- Static resistance load: 800 kg
- Raised edge on 3 sides: avoids tools falling
- Dim. overall (L x D x H): 2 000 x 700 x 816 mm
- 87.0 kg



2000.ROLL6M3G

£1,038.62

HEAVY DUTY WORK BENCHES **JET+**

NEW

1 LENGTH, 2 WORKING HEIGHTS

- Single length: 2 182 mm = large working space
- Height: 850 mm or 1 025 mm

STATIC LOAD RESISTANCE: 1 TONNE

2 CHOICE OF DRAWER BLOCKS

- **6 drawer block:** 4 drawers H 60 mm, 1 drawer H 130 mm, 1 drawer H 270 mm
- **7 drawer block:** 5 drawers H 60 mm, 1 drawer H 130 mm, 1 drawer H 200 mm
- Central locking of drawers with key lock

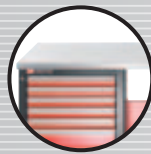

Up to 12 possible combinations!



2 TRAY FINISHES:

- **Wood tray:** depth: 750 mm, thickness 40 mm = hard-wearing and longevity
- **Stainless steel tray:** wood tray covered with brushed stainless steel plating, thickness 40 mm = increased impact and heat resistance

TAMBOUR DOOR CABINET

- Rolling shutter closed with key lock
- Attaches directly to the work surface or the wall

COMPATIBLE WITH ALL JETLINE SYSTEM ELEMENTS

	Wood tray		Stainless steel tray	
	HEIGHT 850 mm	HEIGHT 1 025 mm	HEIGHT 850 mm	HEIGHT 1 025 mm
7 drawer block	JLS2-2MW7DL £1,802.47	JLS2-2MW7DH £1,982.72	JLS2-2MS7DL £1,982.72	JLS2-2MS7DH £2,180.98
13 drawer block (7 + 6 drawers)	JLS2-2MW13DL £2,545.10	JLS2-2MW13DH £2,799.61	JLS2-2MS13DL £2,799.61	JLS2-2MS13DH £3,079.57
7 drawer block + CABINET	JLS2-2MW7DSCL £2,863.37	JLS2-2MW7DSCH £3,149.71	JLS2-2MS7DSCL £3,149.71	JLS2-2MS7DSCH £3,464.67

2 METRE WORK BENCH

2 tray finishes: galvanised or wood

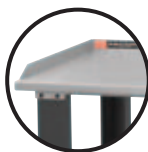

Galvanised tray version

- Dim. overall (L x D x H): 2 000 x 750 x 850 mm
- Static resistance load: 750 kg
- 81,50 kg

WB.2000GSA

£539.36

Wood tray version

- Dim. overall (L x D x H): 2 000 x 750 x 850 mm
- Static resistance load: 1 TONNE
- 70,00 kg

WB.2000WA

£634.23



Adaptable drawer option 7,230 kg

WB.DRAWER

£198.33

JETLINE+ SYSTEM

GLOBAL SOLUTION FOR
WORKSHOP MANAGEMENT



SCAN THIS QR CODE
TO ACCESS OUR
MINI-SITE +
JETLINE

CREATE YOUR MODULAR, SCALABLE AND INNOVATIVE WORK SPACE!



MODULARITY

WORK, STORE, SHARE AND COMMUNICATE



COMFORT

A PLACE WHERE WORK BECOMES A PLEASURE!



SPACE

A MULTITUDE OF OPPORTUNITIES TO MAKE THE MOST OF YOUR SPACE



FREEDOM

RETHINK YOUR WORKSHOP AND CREATE YOUR IDEAL SETUP, EXACTLY HOW YOU WANT

OVER TO YOU TO EXPERIMENT AND DESIGN
THE PERFECT WORKSHOP...



DOWNLOAD OUR 3D CONFIGURATOR (version Windows) from our website www.facom.com and create your personalised working space



PRODUCTS IN THE RANGE

2D VISUALISATION

3D VISUALISATION

YOUR PRODUCT LIST

2 EXAMPLES OF CONFIGURATIONS FOR YOUR WORKSHOP...

1 workbench + low cabinet 6 drawers +
2 panels + 1 tall cabinet



Sketch for guidance only

1 workbench + low cabinet 6 drawers + low
cabinet 2 doors + 2 panels + 2 tall cabinets
+ 1 large cabinet



Sketch for guidance only

REFERENCE	DESCRIPTION	QTY.
JLS2-MBS6T	JETLine+ low furniture 6 drawers 4 jacks with swivel feet for perfect adjustment, centralised locking with key lock	1
JLS2-PBST2	Beech wood tray covered with brushed stainless steel 1 455 mm Increased impact and heat resistance	1
JLS2-TRAA2	Multi-function linking cross-member. Reinforce- ment or storage, option of 2 possible positions	1
JLS2-PPAV2	2 vertical hanging half panels 1 452 mm	1
JLS2-PPAV1	Hanging half panel vertical, 724.5 mm	1
JLS2-CHD	Open wall safe for fast access	1
JLS2-PSH	Foot equipped with jacks, swivel for adjustment ensuring perfect stability	1
JLS2-BASEMBS	Elevate to match a height of 850 to 1 025 mm	1
JLS2-TUBE- SUP800	Assembly kit: fixing system on workstation	2

REFERENCE	DESCRIPTION	QTY.
JLS2-MBSPP	JETLine+ low furniture 2 swing doors Doors mounted on hinges with invisible wire, providing an opening of 110°	1
JLS2-MBS7T	JETLine+ low furniture 7 drawers 4 jacks with swivel feet for perfect adjustment, centralised locking with key lock	1
JLS2-PBST3	Beech wood tray covered with brushed stainless steel 2 182 mm Increased impact and heat resistance	1
JLS2-PPAV2	2 vertical hanging half panels 1 452 mm	1
JLS2-PPAV1	Hanging half panel vertical, 724.5 mm	1
JLS2-CHDPP	Long wall box with liftable sheet metal door L.1446 x D.278 x H.405 mm, key lock	1
JLS2-CHSPP	Wall box with liftable sheet metal door L.719 x D.278 x H.405 mm, key lock	1
JLS2-BASEMBS	Elevate to match a height of 850 to 1025 mm	2
JLS2-A1000PP	JETLine+ large cabinet 2 doors provides a 110° opening. Key lock, 2 points top and bottom. L.1 000 x D.509 x H.1 835 mm	1
JLS2-TUBE- SUP800	Assembly kit: fixing system on workstation	2
JLS2-1KEY	Optional unique key*: Interchangeable cylinder - 1 single key for all JETLine + furniture	5

* This option is free if you request it when ordering furniture.
Otherwise, it is necessary to order the drum as a spare.

PREMIUM PACK 165 TOOLS



Premium set 165 tools

- 18 combination wrenches from 6 to 24 mm (440.JE18)
- 12 open-end wrenches from 6 to 32 mm (440.JE18)
- 10" chromium plated adjustable wrench (113A.10C)
- **Case 1/2" 12-point, 30 items (S.161-5P12):** 1 round head sealed ratchet S.161B, 23 sockets: from 8 to 34 mm accessories: 2 extension bars 130 - 250 mm: universal cardan shaft, cushioned handle, crankshaft
- **Case 1/4" hex, 38 items (R2NANO):** 1 round head ratchet sealed R.161B, 10 sockets: from 5.5 to 14 mm, mixed bits L. 25 mm:
 - 4-6, 5-8 mm ;
 - No.1 - No.2 ;
 - 3 - 4 - 5 - 6 mm, accessories: 2 extension bars 55-100 mm; universal cardan shaft, spinner short L. 158 mm, sliding handle, 1/4" socket bit holder with standard retaining ring
- 5 slotted head screwdrivers:
 - 3 x 75 - 4 x 100 - 5.5 x 100 mm
 - 6.5 x 150 - 8 x 200 mm
- 3 Phillips head screwdrivers®:
 - PH 0-1-2 mm
- 3 Pozidriv head screwdrivers®:
 - PZ 0-1-2 mm
- 4 insulated screwdrivers 1 000 V:
 - 4 x 100 - 6.5 x 150 mm
 - PH 1-2 mm
- 1 electrical screwdriver low voltage (AV.HT1C)
- 1 set of 9 hex offset Allen keys from 1.5 to 10 mm in case (82H.JP9A)
- 1 set of 8 male offset Torx wrenches® in cover: No.10 to 45 (89.JP8)
- 1 pair of sheathed combination pliers (187A.18CPE)
- 1 "control wire" diagonal cutting pliers (192A.16CPE)
- 1 multigrip locking pliers 250 mm (181A.25CPE)
- 1 half-round longnose pliers (185A.20CPE)
- 1 sheathed flat nose pliers (188A.16CPE)
- 1 long arm vice-grip pliers 501A
- 2 circlips pliers® 45° bent internal: 12-25 mm (169A.13) - 18-60 mm (169A.18)
- 2 circlips pliers® 45° bent external: 10-25 mm (167A.13) - 18-60 mm (167A.18)
- 1 measuring tape, 3 m (897A.319)
- 1 metal hacksaw frame (603F)
- 10 "bimetal" saw blades (668A.8)
- 5 STG files
- 1 square tip (AP6X80)
- 1 Riveter hammer, hickory sleeve 32 mm (200H.32)
- 1 plastic tip steel hammer (208A.32CBA)
- 2 sheathed nail set: 2 - 4 mm (247.G)
- 2 sheathed pin punches: 2 - 4 mm (249.G)
- 1 precision chisel (254A.10)
- 1 slim chisel (263.18)
- 1 precision punch 4 mm (256.4)
- 1 electrician knife with stripper (840.1)

CM.130A

£1,804.43

THE FACTORY AT FEUQUIÈRES-EN-VIMEU MORE THAN 90 YEARS OF EXPERTISE

Having specialised in sheet metal processing for 90 years, the Feuquières-en-Vimeu factory, in the Somme (80), is home to Europe's largest production unit for service carts.

It produces more than 900,000 products per year: **service carts, accessories, modular storage (thermoform and foam),** in addition to other items for organising the workshop furniture, and vertical hanging equipment).



Foam modules



Thermoformed modules



Check out the video of our production site



FOAM MODULES

Set of 8 PROTWIST screwdrivers®

AN blade ○

- 3 x 75 - 3.5 x 100 - 4 x 100 - 5.5 x 125
- ✦ 1 x 100 - 2 x 125

Blade AW ○

- 6,5 x 150 - 8 x 175
- Tray PM.MODA1

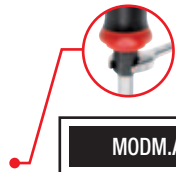

MODM.A1

£98.70

Set of 8 PROTWIST screwdrivers® including 4 "ball handle"

AN blade ○

- 4 x 25 - 5.5 x 35
- ✦ 0 x 75 - 1 x 25
- ✦ 0 x 75 - 1 x 100 - 2 x 35 - 2 x 125

- Tray PM.MODA3

MODM.A3

£89.81

Screwing set

Compactness: all your screwing requirements combined into one set

- 4 x 100 - 5.5 x 150 - 8 x 175
- 0 x 175

- ✦ 1 x 100 - 2 x 125

Set of 9 Allen keys:

- 1.5 - 2 - 2.5 - 3 - 4 - 5 - 6 - 8 - 10 mm

- ✦ Set of 8 male Torx keys®:

- 10 - 15 - 20 - 25 - 27 - 30 - 40 - 45

MODM.A7

£122.76

NEW

FOAM MODULES "PLIERS"



Optimised cutting edges

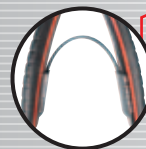

Return spring

Ergonomics and comfort



Hanging hole



Set 4 pliers

- 181A.25CPE 250 mm multigrip pliers
- 185A.20CPE Semi-round pliers 200 mm
- 192A.16CPE Cutting pliers 160 mm
- 501A Vice-grip pliers long, multi-position
- Tray PM.MODCPEA1

MODM.CPEA1

£234.12



Set of 3 pliers + 1 universal cutter

- 181A.25CPE 250 mm multigrip pliers
- 185A.20CPE Semi-round pliers 200 mm
- 192A.16CPE Cutting pliers 160 mm
- Universal blade open
- Tray PM.MODCPEA2

MODM.CPEA2

£188.53

FOAM STORAGE MODULES

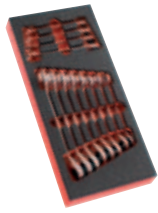

Set of ratchet combination wrenches 467B
467B. • 8 - 9 - 10 - 11 - 12
- 13 - 14 - 15 - 16 - 17
- 18 - 19 mm
• Tray PM.MOD467J12

MODM.467BJ12
£296.56

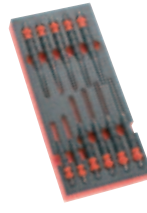

Set of pin punch, sheathed nail and sheathed centre punch
249G. 6 pin punches 2 - 3 - 4 - 5 - 6 - 8 mm
247G. 4 sheathed nails
4 - 5 - 6 - 8 mm
255G. 6 1 centre punch 6 mm diameter
• Tray PM.MODCG

MODM.CG
£143.91

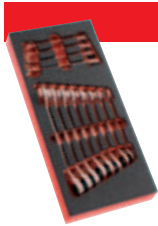

Set 12 articulated ratchet combination wrenches 467BF
467BF. • 8 - 9 - 10 - 11 - 12
- 13 - 14 - 15 - 16
- 17 - 18 - 19 mm
• Tray PM.MOD467FJ12

MODM.467BFJ12
£298.24



Set of hex ratchet-sockets 1/4" + accessories, bits and Allen keys
10 sockets R. 5.5 to 14 mm
Round head sealed ratchet R.161B
Sliding handle 2 extension bars
55 mm and 100 mm
1 bit holder 1 spinner
1 cardan shaft 1 ECR adaptor
Bits: □ ES. 4.5 - 6.5 - 8
⊕ EP. 1 - 2 - 3
⊕ ED. 1 - 2 - 3
⊖ EH. 3 - 4 - 5 - 6 - 7
⊕ No. 15 - 20 - 25 - 27 - 30 - 40
83SH.JP9AAllen keys
1.5 to 10 mm
• PM.MODR1AN Tray

MODM.R161-36
£309.11

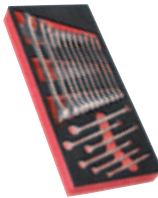

Set of 17 combination wrenches 440
440. 6 - 7 - 8 - 9 - 10 - 11 - 12 - 13 - 14 - 15
- 16 - 17 - 18 - 19 - 21
- 22 - 24 mm
• Tray PM.MOD440-1

MODM.440-1
£187.50



Set of 5 combination wrenches 440 large dimensions
440. 27 - 29 - 30 - 32 - 34 mm
• Tray PM.MOD440-2

MODM.440-2
£183.34

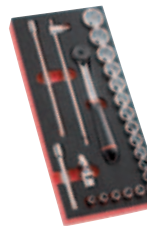

Set of hex ratchet-sockets 1/2" + accessories
• 18 sockets SH. 8 - 10 à 19 - 21 à 24 - 27 - 30 - 32 mm
S.161B Round head sealed ratchet
S.120A Sliding handle 250 mm S.210 Extension bar 130 mm
S.215 Extension bar 250 mm
S.240A Cardan shaft
• Tray PM.MODS1AN

MODM.S1A
£331.85



Set of 13 socket wrenches, series 75
75. 7 - 8 - 9 - 10 - 11 - 12 - 13
- 14 - 15 - 16 - 17 - 18
- 19 mm
• Tray PM.MOD75

MODM.75
£248.72



*Complete drawer
(equivalent of 3 modules)*



Module saw-measurement-files

603FHack saw aluminium frame
668A.10 10-toothed saw blades (pack of 10)
DELA.1051.300 Ruler 300 mm
234.S Scribe marks
893B.3191 Measuring tape, 3 m 5 files:
Flat (PAM.B250EMA)
Half-round (DRD.MD250EMA)
Square (CAR.MD200EMA)
Triangular (TRI.MD200EMA)Round (RD.MD200EMA)
• PM.MOD603F Tray

MODM.603F
£230.22



Impact set
208A.32CBA Steel sledgehammer 32 mm
200C.40 Graphite handle
riveting engineers hammer 40 mm
256.6 6 mm diameter precision punch
263.G19 Sheathed chisel length 190 mm
249.G3 sheathed pin punches
4 - 5 - 6 mm
• Tray PM.MODMI6

MODM.MI6
£161.60

THERMOFORMED MODULES



Set of 8 PROTWIST screwdrivers®

AN blade ○

▮ 3 x 75 - 3.5 x 100 - 4 x 100 - 5.5 x 125

⊕ 1 x 100 - 2 x 125

Blade AW ○

▮ 6.5 x 150 - 8 x 175

• Tray PL.325



MOD.AT1

£82.27



Set of 8 PROTWIST screwdrivers® including 4 "ball handle"

Blade AN ○

● 4 x 25 - 5.5 x 35

⊕ 0 x 75 - 1 x 25

⊕ 0 x 75 - 1 x 100 - 2 x 35 - 2 x 125

• PL.326 Tray

MOD.AT3

£70.42



Set of PROTWIST screwdrivers® insulated 1000 V

● 3.5 - 4 - 5.5 - 6.5 mm

⊕ No.1 - n°2

⊕ No.1 - No.2

• PL.325 Tray



MOD.AT1VE

£105.23



NEW

Set of 7 hex keys with metric ball handle in form of "P"

84TZ.A. 3 mm

84TZ.S.A. 4 - 5 - 6 - 7 -

8 - 10 mm

• Tray PL.MM-A

MOD.84TZSA

£71.94



Set of saws - measures - files

601 Saw frame

668A.10 10 saw blades

234.S Scribe marks

DELA.1051.300 Ruler 300 mm

893B.3191 measuring tape, 3 m

5 files:

Flat PAM.B250EMA

Half-round DRD.MD250EMA

Square CAR.MD200EMA

Triangular TRI.MD200EMA

Round RD.MD200EMA

• PL.335 Tray

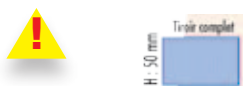

Complete drawer (equivalent 3 modules)



Centre punch Comfort sheathing

MOD.601

£186.59

THERMOFORMED MODULES "PLIERS"

NEW



Optimised cutting edges

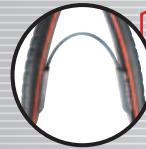

Return spring

Ergonomics and comfort



Hanging hole



Set of 3 CPE "mechanics" pliers

185A.20CPE Semi-round pliers

200 mm

187A.18CPE Combination pliers

180 mm

192A.16CPE Cutting pliers 160

mm

• PL.MODCPEA0 Tray

MOD.CPEA0

£127.47



Set of 5 pliers

181A.25CPE

250 mm multigrip pliers 185A.20CPE

Semi-round pliers 200 mm

192A.16CPE

Cutting pliers 160 mm

195A.20CPE Semi-round

short pliers 200 mm

501A Vice-grip pliers long,

multi-position

• PL.MODCPEA5 Tray

MOD.CPEA5

£259.30



Set of 16 combination wrenches 440

440.6 - 7 - 8 - 9 - 10 - 11 -

12 - 13 - 14 - 15 - 16 - 17 -

18 - 19 - 22 - 24 mm

• PL.670 Tray

MOD.440-1

£168.43



Set of 17 combination

wrenches 440 same as for

MOD.440-1 + 21 mm wrench

• Tray PL.313

MOD.440-1XL

£182.60

THERMOFORM STORAGE MODULES



Set of 10 OGV® hex angled socket wrenches

75. 8 - 10 - 11 - 12 - 13 - 14
- 16 - 17 - 18 - 19 mm
• Tray PL.625

MOD.75-1

£178.53



Set of 12 articulated ratchet combination wrenches 467BF

Designed for environments with little access.
467BF. • 8 - 9 - 10 - 11 - 12
- 13 - 14 - 15 - 16
- 17 - 18 - 19 mm
• PL.680 Tray

MOD.467BFJ12

£253.28



Set of ratchet combination wrenches 467B

467B. 8 - 9 - 10 - 11 - 12 - 13
- 14 - 15 - 16 - 17 - 18
- 19 mm
• Tray PL.652

MOD.467BJ12

£285.95



Set of 6 combination wrenches, large dimensions

467B. 21 - 22 - 24 - 27 - 30 -
32 mm
• Tray PL.653

MOD.467BXL

£339.55



Set of striking tools

200H.32 Hammer
208A.32CBA Sledge hammer
263.20 Chisel
256.6 Centre punch
248. Long pin punches
4 - 5 - 6 mm
• Tray PL.333

MOD.MI1

£131.26



Set of pin punch, sheathed nail and centre punch

6 pin punches: 249G. 2 - 3 - 4 - 5 - 6 - 8 mm
4 sheathed nails:
247G. 4 - 5 - 6 - 8 mm
1 centre punch 255G.6
• Tray PL.334

MOD.CG

£136.59



Set of hex ratchet-sockets 1/4" + accessories, bits and Allen keys

1 round head ratchet R.161B, 10 sockets
R.5.5 to 14 mm
2 extension bars 55 mm and 100 mm
1 115 mm sliding handle, 1 cardan shaft
1 spinner,
1 socket bit holder Bits
• 6.5 - 8
• No.1 - 2 - 3
• No. 1 - 2 • No. 3 - 4 - 5 - 6 - 7 mm
• No. 10 - 15 - 20 - 25 - 30 - 40
2 sets of Allen keys:
• 83SH.JPAA: 1.5 - 2 - 2.5 - 3 - 4 -
5 - 6 - 7 - 8 mm
• 89S.JP8A No.10 - 15 - 20
- 25 - 27 - 30 - 40 - 45
• Tray PL.658



Offer*

Set of male Torx wrenches

MOD.R161-46

£338.59

* for the purchase of a MOD. R161-46 set



Set of hex ratchet-sockets 1/4" + accessories, bits and Allen keys

1 round head sealed ratchet R.161B
10 sockets R.5.5 to 14 mm
2 extension bars 55 mm and 100 mm
1 115 mm sliding handle, 1 universal cardan shaft
1 spinner, 1 socket bit holder
10 short Allen keys 82H. 2 - 10 mm
Bits • 4.5 - 6.5 - 8 • PZ1-2
• 3 - 4 - 5 - 6
• PL.321 Tray

MOD.R161-26

£227.94



Set of hex ratchet-sockets 1/2" + accessories

1 round head sealed ratchet S.161B
• 19 sockets SH. 8 to 19 - 21 à 24 -
27 - 30 - 32 mm
2 extension bars 130 - 250 mm
1 universal cardan shaft S.240A
• Trays PL.M01 + PL.S384

MOD.S161-36

£306.81



Set of 5 files

5 files 200 mm spinner: flat,
half-round,
square, triangular, round.
• PL.606 Tray

MOD.LIM

£85.47



Extraction set

U.306A140 Extractor
U.306G23 Inside pullers
U.306G103 Long grippers, outside
U.14L Compact extractor
• Tray PL.354



Module height = 100 mm for
drawer H = 130 mm

MOD.U306

£507.93

FACOM 5S'

THE BENEFITS OF FACOM TOOLS SUPPORTING YOUR WORKPLACE IN ACHIEVING 5'S THROUGH BESPOKE SOLUTIONS.

At Facom Tools (Stanley Black and Decker) we pride ourselves in working with our customer base to achieve bespoke tooling solutions to suit their business needs. The key definition of 5's listed below can be achieved by working with us to ensure the correct solutions are put in place. For more information please feel free to contact your area sales manager.

THE 5 STEPS ARE AS FOLLOWS:

SORT	Sort out & separate that which is needed & not needed in the area.
STRAIGHTEN	Arrange items that are needed so that they are ready & easy to use. Clearly identify locations for all items so that anyone can find them & return them once the task is completed.
SHINE	Clean the workplace & equipment on a regular basis in order to maintain standards & identify defects.
STANDARDISE	Revisit the first three of the 5S on a frequent basis and confirm the condition of the Gemba using standard procedures.
SUSTAIN	Keep to the rules to maintain the standard & continue to improve every day.

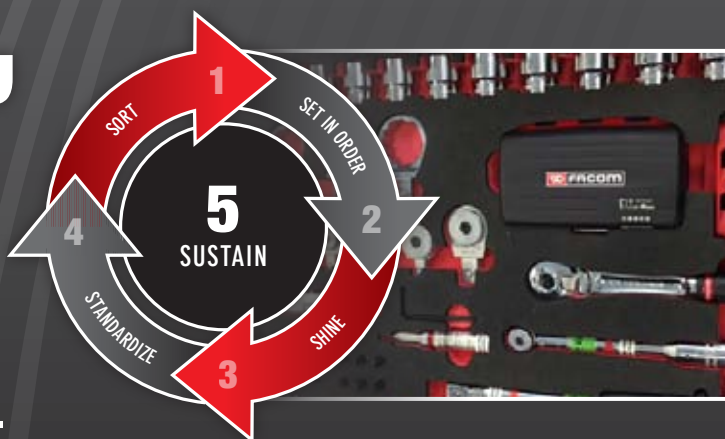

BENEFITS OF 5S WORKPLACE ORGANISATION

5S relates to workplace organisation and forms a solid foundation upon which many organisations base their drive for continuous improvement. It is equally applicable & successful in all sectors helping to achieve high impact results.

It is a systematic and methodical approach allowing teams to organise their workplace in the safest and most efficient manner.

The discipline to check & repair equipment is included & adopted. The entire process is managed through the use of team generated audit documents, completed on an agreed frequency by responsible owners within the Gemba.

SUMMARY

- Improved safety
- 5S becomes a fundamental business measure & key driver for Kaizen
- Forms a solid foundation upon which to build continuous improvement
- Employees gain a sense of ownership, involvement & responsibility
- Reduction in waste – as defined by Ohno's seven forms of waste
- Improved performance in productivity, quality & morale leads to increased profitability

INDUSTRIAL END USER TECHNICAL TEAM



GARY MCEVOY

TECHNICAL CONTACT
NORTHERN IRELAND
00353 861740447
GARY.MCEVOY@SBDINC.COM



JON GROVES

AREA SALES MANAGER - TECHNICAL
NORTH EAST
07747 820749
JONATHAN.GROVES@SBDINC.COM



STEPHEN WILKINS

AREA SALES MANAGER - TECHNICAL
NORTH WEST & NORTH WALES
07979708793
STEPHEN.WILKINS@SBDINC.COM

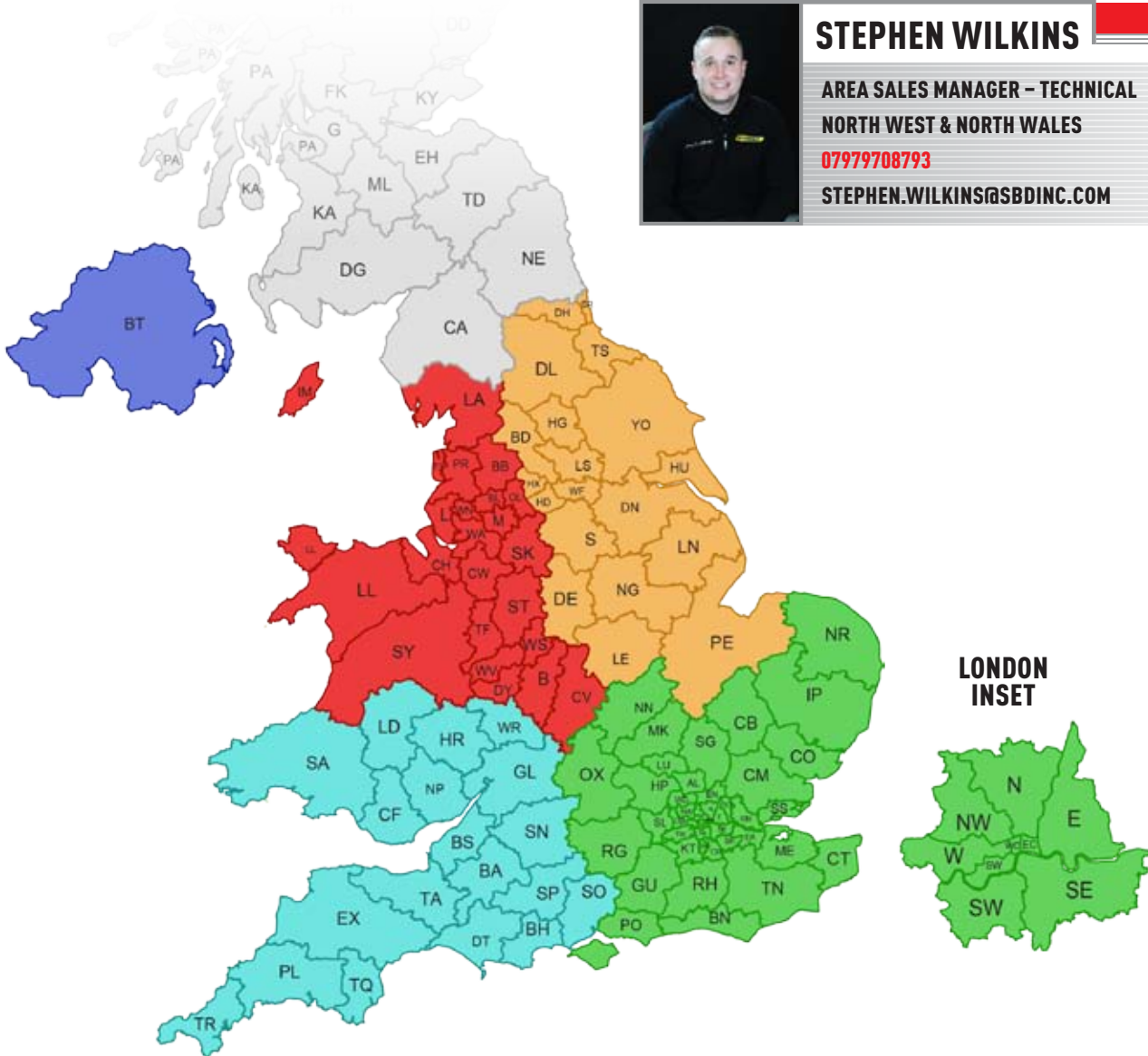

LEON CARTER

AREA SALES MANAGER - TECHNICAL
SOUTH WEST & SOUTH WALES
07867 202858
LEON.CARTER@SBDINC.COM



ANDY EVANS

AREA SALES MANAGER - TECHNICAL
SOUTH EAST
07717 631378
ANDREW.EVANS@SBDINC.COM



**FACOM GUARANTEES
ITS PRODUCTS
AGAINST FAULTY MATERIALS
OR WORKMANSHIP
UNDER THE CONDITIONS
DEFINED BELOW.**



The FACOM Guarantee is fully part of the brand's commitments towards its clients. It ensures total satisfaction with FACOM products.

Over the last 60 years, FACOM guarantees the quality of its products, by means of free replacement or repair guarantee of its products without any time limit (excluding technical products, torque tools, roller cabinets and furniture).

The **FACOM Guarantee** is applicable by all FACOM dealers.

FACOM has implemented a specific organisation to manage and follow up returned products, for unequalled responsiveness to client requests:

- Returned products are first managed by the distributor network, entrusted with applying the **FACOM Guarantee** and replacing items on stock (under reservation of availability).
- Daily processing of returns within FACOM, by an 18-person department dedicated to applying the warranty.

IMPLEMENTATION OF THE GUARANTEE

- The FACOM guarantee takes the form of an exchange or repair limited to replacement of the faulty parts in accordance with the terms and conditions specified below.
- The faulty product must be returned to the Facom distributor, failing which repair under guarantee may be refused.
- This guarantee includes the parts and the labour provided by the Facom after sales service or the approved distributor.
- All repairs are guaranteed six months parts and labour. This guarantee only applies to the components changed during the previous repair, with the exception of consumables.
- In line with its policy of continual product improvements to meet user needs and technological developments, Facom may upgrade or discontinue the models shown in its catalogue without notice and without entailing any obligation on

its part to repair tools or equipment sold previously. Those items no longer included in the range will then be replaced by a technically equivalent product or a credit note will be issued.

CONDITIONS OF APPLICATION OF THE FACOM GUARANTEE

UNLESS OTHERWISE SPECIFIED, THE FACOM GUARANTEE APPLIES TO ALL TOOLS UNDER NORMAL CONDITIONS OF USE.

The guarantee excludes the following :

Consumables (i.e. products that become deteriorated or damaged during use). These include, but are not limited to, drill bits, saw blades, abrasive discs, knife blades, files, batteries, driving bits, etc.

Normal wear and tear (in particular of wearing parts), failure to use the product for its intended purpose or in accordance with our instructions, neglect or inadequate maintenance on the part of the user.

Defective operation due to modifications or repairs not carried out by Facom's after sales service or that of its approved distributors. Defective operation due to causes external to the pro-

duct (theft, dropping, lightning, flooding, fire, damage during transport, product not returned in its original packaging, etc.).

- The guarantee period takes effect from the date of purchase by the customer from the Facom customer-distributor. A copy of the invoice proving the date of purchase from the distributor may be requested in the event of a claim under the guarantee. In the case of technical products covered by a limited guarantee type D, it shall systematically be supplied by the user customer together with the serial number where one is indicated on the tool.
- The guarantee will apply for the period indicated in the price list applying on the date of purchase.

- Where the product is no longer covered by the guarantee (expiry of the guarantee period, guarantee inapplicable for the reasons given in paragraph 2) yet is repairable, this repair will be carried out only after acceptance by the user of the repair estimate.
- The application of the guarantee will not give risk to any kind of indemnity or damages for any reason whatsoever.

TYPES OF GUARANTEE (PRICE LIST COLUMN G)

GUARANTEE TYPE E : the tool will be exchanged free of charge, in accordance with the conditions of implementation and application of the guarantee (cf. paragraphs 1 and 2 above) and without limit of time.

GUARANTEE TYPE R : the tool will be repaired or replaced with a repaired tool in a similar condition in accordance with the conditions of implementation and application of the guarantee (cf. paragraphs 1 and 2 above) and without limit of time.

GUARANTEE TYPE D : this guarantee is subject to a time limit. The guarantee period is specified by a figure after

the D. It applies mainly to technical products or machines. In accordance with the conditions of implementation and application of the guarantee (in particular the exclusion of wearing parts - cf. paragraphs 1 and 2 above), this guarantee covers the repair and replacement of defective parts, free of charge, during the period of validity.

- In the event that Facom is no longer able to exchange a product under guarantee with another having the same reference, it undertakes to provide a technically equivalent product or to issue a credit note if no corresponding product is available.

- The type of guarantee applying to a product can be determined simply by referring to the current price list (column G) available at any Facom distributor. For certain product references, the type of guarantee is indicated on the packaging or in the accompanying documentation.
- Those items for which no guarantee type is specified (column G empty), are covered only by the statutory guarantee.
- Each item of a set continues to be covered by its own guarantee jurisdiction. Applicable legislation.

JURISDICTION. APPLICABLE LEGISLATION

IN THE EVENT OF PROBLEMS CONCERNING THE APPLICATION HEREOF, THE USER CAN CONTACT:

In France :

– Facom Customer Services, 6 and 8 rue Gustave Eiffel, 91420 Morangis.

Outside France:

– The Facom subsidiaries listed on page 868 of the Catalogue and on the Facom Web site www.facom.fr
– Facom distributors

- Any dispute in relation to the interpretation or execution hereof that cannot be amicably resolved between the parties will be subject to French law and the sole jurisdiction of the Paris Courts.

TERRITORIAL EXTENT

The FACOM contractual guarantee applies in all countries in which the product is officially sold and distributed.

STATUTORY GUARANTEE

Irrespective of the FACOM contractual guarantee, the user is also covered by the provisions of articles 1641 to 1649 of the French Civil Code relating to hidden defects.

